



THE HIGHWAYS AGENCY

HA 68/94



THE SCOTTISH OFFICE DEVELOPMENT DEPARTMENT



THE WELSH OFFICE  
Y SWYDDFA GYMREIG



THE DEPARTMENT OF  
THE ENVIRONMENT FOR NORTHERN IRELAND

# Design Methods for the Reinforcement of Highway Slopes by Reinforced Soil and Soil Nailing Techniques

**Summary:** This Advice Note gives guidance on design methods for the strengthening of highway earthwork slopes.

**REGISTRATION OF AMENDMENTS**

| Amend No | Page No | Signature & Date of incorporation of amendments | Amend No | Page No | Signature & Date of incorporation of amendments |
|----------|---------|---|----------|---------|---|
|          |         |   |          |         |   |

REGISTRATION OF AMENDMENTS

| Amend No | Page No | Signature & Date of incorporation of amendments | Amend No | Page No | Signature & Date of incorporation of amendments |
|----------|---------|---|----------|---------|---|
|          |         |   |          |         |   |

---

VOLUME 4      GEOTECHNICS AND  
DRAINAGE  
SECTION 1      EARTHWORKS

---

**PART 4**

**HA 68/94**

**DESIGN METHODS FOR THE  
REINFORCEMENT OF HIGHWAY  
SLOPES BY REINFORCED SOIL AND  
SOIL NAILING TECHNIQUES**

**Contents**

Chapter

1. Introduction
2. Design Principles
3. Design Procedure for Reinforcing Highway Slopes with Horizontal Reinforcement
4. Design Procedure for Reinforcing Highway Slopes with Inclined Reinforcement
5. Glossary of Symbols
6. References
7. Enquiries

- Appendix A: The two-part wedge mechanism  
Appendix B: Non-competent foundation material  
Appendix C: Corrosion of metallic reinforcement and soil nails  
Appendix D: The calculation of pull-out resistance of soil nails  
Appendix E: Front-face pull-out in the absence of facing elements or wrap-round reinforcement  
Appendix F: Optimum vertical layer spacing  
Appendix G: Checking other internal mechanisms  
Appendix H: Hybrid construction  
Appendix I: Modifications to basic soil nailing design method  
Appendix J: Worked examples

# 1. INTRODUCTION

## General

1.1 This Advice Note gives guidance on the design requirements for the strengthening of highway earthworks using reinforced soil and soil nailing techniques. The Advice Note applies to the construction of new earthworks, the widening of existing embankments, the steepening of existing cuttings, and the repair of failed slopes.

## Definitions

1.2 For the purposes of this Advice Note the terms "reinforced soil" and "soil nailing" are defined as follows:

*reinforced soil is the technique whereby fill material (frictional or cohesive) is compacted in successive layers onto horizontally placed sheets or strips of geosynthetic or metallic reinforcement*

*soil nailing is the technique whereby in situ ground (virgin soil or existing fill material) is reinforced by the insertion of tension-carrying soil nails. Soil nails may be of either metallic or polymeric material, and either grouted into a predrilled hole or inserted using a displacement technique. They will normally be installed at a slight downward inclination to the horizontal.*

## Scope

1.3 This Advice Note relates to earthworks requiring the Overseeing Department's Geotechnical Certification procedure (see HD 22 (DMRB 4.1.2)). It does not cover retained slopes considered as structures which require Technical Approval (see BD 2: Part I (DMRB 1.1)).

1.4 It provides a single unified design approach for all types of reinforced highway earthworks with slope angles to the horizontal in the range  $10^\circ$  to  $70^\circ$ , and soil types in the strength range  $\phi' = 15^\circ$  to  $50^\circ$ . Values of  $c'$  may be included, as well as pore water pressures and limited uniform surcharge applied at the top of the slope. It applies equally to new slope construction and the steepening and repair of existing slopes. It provides a consistent design method for both reinforced soil (*horizontal* reinforcement) and soil nailing (*inclined* reinforcement), and also covers hybrid construction

which incorporates both techniques. It does not cover the design of the facings of retained slopes.

1.5 Some design tables are provided in this Advice Note, however these represent only a partial range of the cases covered. For the full range of applications it is recommended that the user either develops a computer program based on the general equations or purchases a suitable software package. It is the user's responsibility to be satisfied with the accuracy and applicability of any such program or software.

1.6 Design advice is contained within the main text and reference to the accompanying set of appendices is only necessary for more detail, for the explanation of approaches adopted and for information on designing strengthened slopes in unusual situations. A glossary of symbols and a set of worked examples are also included.

1.7 Design Organisations may choose to use an alternative method provided they are satisfied that it is suitable for the proposed application.

## Implementation

1.8 This Advice Note should be used forthwith for all schemes currently being prepared provided that, in the opinion of the Overseeing Department, this would not result in significant additional expense or delay progress. Design Organisations should confirm its application to particular schemes with the Overseeing Department.

## Mutual Recognition

1.9 The procurement of reinforcement of highway slopes by reinforced soil and soil nailing techniques will normally be carried out under contracts incorporating the Overseeing Department's Specification for Highway Works (Manual of Contract Documents for Highway Works Volume 1). In such cases products conforming to equivalent standards and specifications of other member states of the European Economic Area and tests undertaken in other member states will be acceptable in accordance with the terms of the 104 and 105 Series of Clauses of that Specification. Any contract not containing these clauses must contain suitable clauses of mutual recognition having the same effect regarding which advice should be sought.

## 2. DESIGN PRINCIPLES

### General

2.1 A limit equilibrium approach is adopted based on a two-part wedge mechanism. The two-part wedge mechanism is preferred because it provides a simple method for obtaining safe and economical solutions and is particularly suitable to reinforced soil and soil nailing geometries. It is inherently conservative when compared to more exact solutions and allows simple hand check calculations to be carried out. The two-part wedge mechanism is discussed in more detail in Appendix A. The design approach is not restricted to a constant length of reinforcement or constant spacing of reinforcement and can accommodate any reinforcement layout geometry.

2.2 Design is based on limit state principles incorporating partial factors. The slope is designed for both the ultimate and serviceability limit states in this context. The ultimate limit state is defined as being when a collapse mechanism forms (ie an upper bound solution). The serviceability limit state is defined here as being when movements affect the function of the slope, or of adjacent structures or services. The nominal design life for reinforced earthwork slopes should be taken as 60 years.

2.3 The design method is based on the assumption that a competent bearing material exists beneath the retained slope which is stronger than the slope fill. Further guidance is given in Appendix B if this is not the case.

2.4 The contribution of soil reinforcement and soil nails is assumed to be purely axial. The relatively small effect of the bending stiffness of any reinforcing elements is ignored. This design assumption is conservative.

### Partial Safety Factors

2.5 For the purposes of the limit equilibrium calculation, it is assumed that a set of driving forces is in equilibrium with a set of resisting forces. The driving forces are a function of the self weight of the soil plus any surcharge load, and are factored by a partial factor of unity. The resisting forces are represented by the shear strength of the soil and the reinforcement force, for which "design values" are used

carrying the subscript "<sub>des</sub>" in the text. The "design values" may represent the "characteristic values" (where these are available) reduced by material partial safety factors. The design values of parameters are discussed in detail in paragraphs 2.10 to 2.35.

2.6 Due to the inherent conservatism of the mechanisms invoked in the design, no further factors of safety need be applied in addition to the partial factors described above.

### Definition of Two-part Wedge Mechanism

2.7 The geometry of the two-part wedge mechanism is shown in Figure 2.1. The constraints on the mechanism are that the inter-wedge boundary should be vertical, and that the base of the lower wedge should intersect the toe of the slope (see Appendix A for further details). Provided that these two constraints are observed, the mechanism may take any form. Mechanisms which outcrop higher up on the front face of the slope may be analysed by taking the appropriate reduced height of the slope. As shown in Figure 2.2, the inter-wedge boundary may lie to the left or right of the slope crest, and the upper wedge may also outcrop to the left or right of the slope crest.

2.8 The forces acting on the two wedges are shown on Figure 2.3. By resolving forces parallel and perpendicular to the lower surface of each wedge in turn, and assuming limiting friction (ie  $R' = N' \tan \phi'$ , Figure 2.3), a general formula may be derived. However, the general formula is unwieldy and cannot be solved for the total quantity of reinforcement force required,  $T_{tot}$ , without an assumption regarding the distribution of the reinforcement force in the slope (for example uniform distribution, or increasing linearly with depth). However the general formula may be considerably simplified by the conservative assumption that the inter-wedge angle of friction is zero, because the value of  $T_{12}$  on Figure 2.3 then becomes irrelevant.

2.9 The expression for the total quantity of horizontal reinforcement force required,  $T_{tot}$  then simplifies to:

$$\begin{aligned}
 T_{\text{tot}} &= T_1 + T_2 \\
 &= \frac{[(W_1 + Q_1)(\tan\theta_1 - \tan\phi'_1) + (U_1 \tan\phi'_1 - K_1)/\cos\theta_1]}{(1 + \tan\theta_1 \tan\phi'_1)} \\
 &+ \\
 &\frac{[(W_2 + Q_2)(\tan\theta_2 - \lambda_s \tan\phi'_2) + \lambda_s(U_2 \tan\phi'_2 - K_2)/\cos\theta_2]}{(1 + \lambda_s \tan\theta_2 \tan\phi'_2)}
 \end{aligned}
 \tag{Eqn 1}$$

where the terms are defined in the Glossary (Chapter 5), and the derivation of this formula is provided in Appendix A. A computer program may be written for this expression for  $T_{\text{tot}}$  and used as described in the following paragraphs to identify critical failure mechanisms. Simple algebraic expressions for each of the main variables are given in Table 2.1 and the programmer will find it possible to simplify some of the formulae given in this table. The values of these expressions depend on whether the inter-wedge boundary lies to the left or right of the crest and also whether Wedge 1 outcrops above the slope or on the slope face as shown in Figure 2.4. Therefore each of these cases is considered separately in Table 2.1 and case 1 is typically the most common situation.

**Design Values for Parameters**

*Soil Strength*

2.10 The philosophy of the design method is to use soil strength parameters  $\phi'_{\text{des}}$ ,  $c'_{\text{des}}$  which represent minimum conceivable values in the field, so that no further overall factor of safety would need to be applied to the design.

2.11 Figure 2.5 illustrates two types of soil; one where the minimum conceivable value of soil strength is represented by the critical state parameters  $\phi'_{\text{cv}}$ ,  $c'_{\text{cv}}$  (where  $c'_{\text{cv}}$  will normally be zero) and the second in which very low residual strengths,  $\phi'_r$ ,  $c'_r$  (where  $c'_r$  will also normally be zero) can develop at large displacements, lower than  $\phi'_{\text{cv}}$ ,  $c'_{\text{cv}}$ . These two types of soil may be categorised by plasticity index (PI) (Figure 2.6).

*Granular Soils (and Cohesive Soils with PI < 25%)*

2.12 In the case of granular soils and cohesive soils with PI < 25%, shear box tests taken to large displacement or drained triaxial tests should be conducted until the post peak plateau is identified to obtain  $\phi'_{\text{cv}}$ ,  $c'_{\text{cv}}$ . The values of  $\phi'_{\text{cv}}$  from these tests are likely to represent conservative values for use in plane strain calculations. Alternatively, an estimate of the

plane strain value of  $\phi'_{\text{cv}}$  may be based on the plane strain values of  $\phi'_{\text{pk}}$  and  $\psi$  measured in standard shear box tests, where  $\psi$  is the angle of dilation, using the relationship  $\phi'_{\text{cv}} = \phi'_{\text{pk}} - 0.8\psi$  (Bolton, 1986). Or the plane strain value of  $\phi'_{\text{cv}}$  may be estimated from the angle of repose in a tilting table test (Cornforth, 1973). Values of  $\phi'_{\text{cv}}$  will generally lie in the range 30°-35° for granular fills and in the range 20°-25° for low plasticity clay fills.

2.13 The design values for the soil shearing resistance ( $\phi'_{\text{des}}$ ,  $c'_{\text{des}}$ ) should be taken as:

$$\begin{aligned}
 \tan \phi'_{\text{des}} &= \tan \phi'_{\text{cv}} \\
 c'_{\text{des}} &= c'_{\text{cv}}
 \end{aligned}$$

where the value of  $c'_{\text{cv}}$  would normally be zero.

2.14 For these types of soil it may sometimes be overconservative, however, to adopt  $\phi'_{\text{cv}}$ ,  $c'_{\text{cv}}$  for design, and the following alternative definition for  $\phi'_{\text{des}}$ ,  $c'_{\text{des}}$  may be adopted if this gives a higher value than the method above:

$$\begin{aligned}
 \tan \phi'_{\text{des}} &= \tan \phi'_{\text{pk}} / f_s \\
 c'_{\text{des}} &= c'_{\text{pk}} / f_s
 \end{aligned}$$

where the factor  $f_s$  might take a value in the range 1.3 - 1.5 depending on the application and intended design life ( eg. 1.3 for well understood soil conditions or temporary works; 1.5 for long term permanent works). In no case should the value of  $c'_{\text{des}}$  be assumed to be greater than 5kN/m<sup>2</sup> as a long term, large strain strength parameter. The two approaches are compared graphically in Figure 2.7.

*Cohesive Soils (with PI > 25%)*

2.15 In the case of cohesive plastic soil with PI > 25%, large displacement shear box tests (either ring shear tests or repeated standard shear box tests) should be undertaken. The value chosen for  $\phi'_{\text{des}}$  will depend on whether residual strengths are likely to develop during the design lifetime of the slope. If relic shear surfaces are known to exist, or if sufficient

displacement is likely to develop (or have already developed) such that shearing resistance will reduce (or has already reduced) to residual values along any given surface (eg pull-out failure or base sliding), then the design values for the soil shearing resistance ( $\phi'_{des}$ ,  $c'_{des}$ ) should be taken as:

$$\begin{aligned} \tan \phi'_{des} &= \tan \phi'_r \\ c'_{des} &= 0 \end{aligned}$$

The possibility of progressive failure should be carefully considered.

If, however, displacements are likely to be small, and no pre-existing relic shear surfaces have been detected then it is appropriate to set  $\phi'_{des}$ ,  $c'_{des}$  as follows:

$$\begin{aligned} \tan \phi'_{des} &= \tan \phi'_{cv} \\ c'_{des} &= c'_{cv} \end{aligned}$$

where  $c'_{cv}$  would normally be zero.

2.16 In some cases  $\phi'_{cv}$  may not be well defined, however, on a load displacement plot such as that shown on Figure 2.5. In this case a factored  $\phi'_{pk}$  value may be used instead of  $\phi'_{cv}$ . On any given two-part wedge mechanism it may be reasonable to use different values of  $\phi'_{des}$  on each wedge; for example, for a cutting in stiff plastic clay with horizontal bedding, it may be reasonable to assume  $\phi'_r$  along the base of Wedge 2 (if  $\theta_2 \approx 0$ ) and  $\phi'_{cv}$  along the base of Wedge 1 (Figure 2.8).

### Soil/Reinforcement Interface

2.17 In the case of soil shearing over a reinforcement layer, the interface friction parameters  $\phi'_{int}$ ,  $c'_{int}$  should be obtained either from the BBA certificate, or measured in a modified direct shear box test taken to large displacement in which shearing is induced at the reinforcement surface. Both the bottom and the top halves of the shear box should be filled with soil. It is convenient to define an interface sliding factor,  $\alpha$ , such that:

$$\alpha = \frac{\sigma'_v \tan \phi'_{int} + c'_{int}}{\sigma'_v \tan \phi'_{des} + c'_{des}}$$

The interface sliding factor,  $\alpha$ , is discussed further in paragraphs to 2.24 to 2.33.

### Pore Water Pressures

2.18 Pore water pressures are likely to vary during the design life of the earthworks, and are relatively less well controlled than other parameters. Therefore conservative values of pore water pressures should be chosen for design.

The magnitude of pore pressure quantities  $U_1$ ,  $U_2$  in Table 2.1 have been computed in terms of the pore water pressure parameter,  $r_u$  (Bishop and Morgenstern, 1960):

$$r_u = u/\gamma h$$

where  $u$  = porewater pressure  
 $\gamma$  = unit weight of the soil  
 $h$  = depth of overburden directly above the point in question

Some typical flow conditions with corresponding expressions for  $r_u$  are summarised in Figure 2.9 (from Mitchell, 1983).

Alternatively, expressions for  $U_1$  and  $U_2$  may be derived as shown in Figure 2.10 by drawing a flow net and summing the total water pressures acting at the boundaries of each wedge.

### Reinforcement Rupture Strength

#### Reinforced Soil

2.19 The design value for the reinforcement strength per metre width of slope,  $P_{des}$ , should allow for the appropriate design life, method of installation and the expected in situ soil and groundwater conditions.

2.20 The design value,  $P_{des}$  should be derived from the unfactored long term characteristic strength,  $P_c$  for ex-works product using a set of partial safety factors as follows:

$$P_{des} = P_c / (f_d f_e f_m) \text{ kN/m}$$

where:

$P_c$  = characteristic strength (in kN/m) corresponding to the required design life and the design temperature  
 $f_d$  = factor for mechanical damage before and during installation  
 $f_e$  = factor for environmental effects during design life (chemical and biological)



$f_m$  = factor to cover variabilities and uncertainties in material strength (including extrapolation of data)

Values for  $P_c$ ,  $f_d$ ,  $f_e$ ,  $f_m$  may be taken from the BBA certificate, or manufacturer's literature. Further guidance is given in CIRIA RP396.

2.21 In the event that metallic reinforcement is used, then  $P_c$  in the above should be replaced by  $(\sigma_y A)$  where  $\sigma_y$  is the yield strength of the metal and  $A$  is the cross sectional area of the reinforcement per metre width of slope. The value of  $f_c$  should in this case also take into account the effects of corrosion. This may be considered in terms of an allowance for sacrificial material as discussed in Appendix C.

### Soil Nailing

2.22 The design value for the strength of metallic soil nails per metre width of slope,  $P_{des}$  should be derived from the supplier's quoted yield strength for the bar, and a set of appropriate partial safety factors as follows:

$$P_{des} = \sigma_y A / (f_d f_e f_m S_h)$$

where:

$\sigma_y$  = yield strength  
 $A$  = cross sectional area of bar  
 $S_h$  = horizontal spacing of nails

In the event that a material other than steel (eg a polymeric product) is used in the soil nail, then the term  $(\sigma_y A)$  in the above equation may be replaced by the unfactored long term strength of the product quoted on the BBA certificate or manufacturer's literature.

### Reinforcement Pull-out Resistance

2.23 Where an assumed failure surface cuts a layer of reinforcement or row of soil nails, the force mobilised in the reinforcement or nails is assumed to be the lesser of the rupture strength defined above, and the pull-out resistance of the length of reinforcement or nails which lies beyond the failure surface. In its most general form the pull out resistance of each layer of reinforcement is given by:

$$P_{des} = \lambda_p L_e (\sigma'_n \tan \phi'_{des} + c'_{des}) \text{ (kN/m)}$$

where  $\lambda_p$  is a non-dimensional pull-out factor (defined

for each reinforcement type below);  $L_e$  is the length of reinforcement type which extends beyond the critical failure mechanism; and  $\sigma'_n$  represents the normal effective stress acting on the reinforcement beyond the failure surface. The measurement of pull-out resistance in laboratory tests is not recommended at present due to unknown boundary effects. If required, pull-out tests should be conducted on site under realistic and well understood boundary conditions.

### Geotextiles

2.24 The values of the pull-out factor,  $\lambda_p$ , and the normal effective stress,  $\sigma'_n$ , for geotextiles should be taken as:

$$\lambda_p = 2\alpha$$

$$\sigma'_n = \sigma'_v$$

where  $\alpha$  is the interface sliding factor, and  $\sigma'_v$  is the average vertical effective stress acting at the level of the reinforcement ( $=\gamma z [1-r_u]$ ).

### Geogrids

2.25 For geogrids, pull-out resistance is controlled primarily by *bearing* stress acting on the cross-members, rather than by interface sliding. Hence:

$$\lambda_p = 2\alpha'$$

$$\sigma'_n = \sigma'_v \text{ (as for geotextiles)}$$

where  $\alpha'$  is the "bearing factor". A full discussion of this is given in Jewell, 1990 (Note that in the paper  $\alpha = f_{ds}$ ,  $\alpha' = f_b$ ).

Values of  $\alpha'$  may either be taken from the BBA certificate, measured in field trials or calculated by the method given in Jewell (1990), where the appropriate bearing stresses acting on the front of the cross-members are taken into account.

### Strip Reinforcement

2.26 The values of the pull-out factor,  $\lambda_p$ , and the normal effective stress,  $\sigma'_n$ , for strip reinforcement should be taken as:

$$\lambda_p = 2\alpha b$$

$$\sigma'_n = \sigma'_v$$

where  $\alpha$  is the interface sliding factor;  $b$  is the width of reinforcement per unit width of slope; and  $\sigma'_v$  is the average vertical effective stress at the level of the reinforcement ( $=\gamma z [1-r_u]$ ).

*Soil Nails*

2.27 The values of the pull-out factor,  $\lambda_p$ , and the normal effective stress,  $\sigma'_n$ , for inclined soil nails should be taken as:

$$\begin{aligned} \lambda_p &= \pi d_{\text{hole}} \alpha / S_h \\ \sigma'_n &= \text{average radial effective stress (see Appendix D)} \end{aligned}$$

where  $d_{\text{hole}}$  is the diameter of the grout hole around the nail (=  $d_{\text{bar}}$  for non-grouted nails);  $\alpha$  is the interface sliding factor; and  $S_h$  is the horizontal spacing of the nails.

2.28 The calculated value of nail pull-out, above, may underestimate actual pull-out strength in granular soils, and overestimate it in clayey soils (see Appendix D). It is recommended that pull-out tests are carried out on site under well understood boundary conditions and slowly enough for excess pore water pressures to be negligible.

*Discussion on the Interface Sliding Factor,  $\alpha$*

2.29 For the case of  $c'_{\text{des}} = 0$ ,  $\alpha$  is defined simply as:

$$\alpha = \tan \phi'_{\text{int}} / \tan \phi'_{\text{des}}$$

If a non-zero value of  $c'_{\text{des}}$  is to be used (ie. for cohesive soils with  $PI < 25\%$  using the  $f_s$  method - see paragraph 2.14) then  $\alpha$  becomes:

$$\alpha = (\sigma'_v \tan \phi'_{\text{int}} + c'_{\text{int}}) / (\sigma'_v \tan \phi'_{\text{des}} + c'_{\text{des}})$$

in order for this value of  $\alpha$  to be a constant for varying  $\sigma'_v$ , it will be necessary to construct a best fit line passing through the interface shear test data ( $\phi'_{\text{int}}$ ,  $c'_{\text{int}}$ ), for the relevant stress range, to also pass through the same point X (see Figure 2.12) as the soil shear test data ( $\phi'_{\text{des}}$ ,  $c'_{\text{des}}$ ), so that:

$$\alpha = (\tan \phi'_{\text{int}} / \tan \phi'_{\text{des}}) = (c'_{\text{int}} / c'_{\text{des}})$$

2.30 For the case of cohesive soils with  $PI > 25\%$ , a zero value should be taken for  $c'_{\text{int}}$ . The value of  $\phi'_{\text{int}}$  should be based on a residual angle of interface friction for these soils, unless it can be demonstrated that relative displacements between the reinforcement layer or soil nail and the soil during the mobilisation of working loads will not be sufficient to cause residual strengths to develop. The extensibility of the reinforcement or soil nails should be taken into account and progressive failure should be considered.

2.31 For the special case of a layer of reinforcement lying at the interface of two soil types (eg on a bench, or at the base of the reinforcement zone) then the relevant values of  $\phi'_{\text{int}}$  for the upper and lower surfaces should be used respectively. The enhancement of pull-out resistance by special measures such as placing a thin layer of granular material directly below and above each reinforcement layer in a clay fill, or the use of expanding grout in soil nails may also be considered.

*Front Face Pull-out*

2.32 If layers of reinforcement are not "wrapped around" or otherwise fixed at the front face of the slope (Figure 2.14a), then front-face pull-out resistance should also be considered. Guidance on the calculation of front face pull-out resistance is given in Appendix E. Likewise for soil nailing, if the front face is not fixed by shotcrete or other means (Figure 2.14a), then the adequacy of the front face waling plate in bearing should be checked (see Appendix E).

**Base Sliding Resistance**

2.33 When the base of the lower wedge (wedge 2) is sliding over a layer of reinforcement (i.e.  $\theta_2 = 0$  for horizontally placed reinforcement; or  $\theta_2 = -\delta$  for soil nails), then  $\lambda_s$ , a non-dimensional base sliding factor, should be incorporated into the terms  $R_2'$  and  $K_2$  (Figure 2.3) as follows (for all other values of  $\theta_2$ ,  $\lambda_s$  assumes a value of unity):

$$\begin{aligned} R_2' &= \lambda_s N_2' \tan \phi'_{\text{des}} \\ K_2 &= \lambda_s c'_{\text{des}} m \end{aligned}$$

This is already taken into account in Equation 1, paragraph 2.9.

The appropriate values of  $\lambda_s$  for each reinforcement type are as follows:

|                     |  |
|---------------------|--|
|                     | $\lambda_s$  |
| Geotextiles         | $\alpha$   |
| Geogrids            | $\alpha$   |
| Strip reinforcement | $\alpha b + (1-b)$                                       |
| Soil nails          | $(\alpha d_{\text{hole}}/S_h) + (1-d_{\text{hole}}/S_h)$ |

where  $\alpha$  is the interface sliding factor;  $b$  is the width of reinforcement per unit width of slope;  $d_{\text{hole}}$  is the effective nail diameter; and  $S_h$  is the horizontal spacing.

**Surcharge**

2.34 Uniform vertical surcharge on the slope crest may be treated either explicitly using the terms  $Q_1$  and  $Q_2$  (the latter only when the inter-wedge boundary falls uphill of the crest) as defined on Figure 2.3 and Table 2.1, or more simply as an equivalent additional thickness of fill. In the case of the latter, the effective height of the slope,  $H'$ , to be used in calculations then becomes

$$H' = H + (q/\gamma)$$

|       |          |   |                     |                      |
|-------|----------|---|---------------------|----------------------|
| where | $H$      | = | actual slope height | (m)                  |
|       | $q$      | = | surcharge           | (kN/m <sup>2</sup> ) |
|       | $\gamma$ | = | unit weight of fill | (kN/m <sup>3</sup> ) |

and the value of  $H'$  should be substituted for  $H$  in each of the expressions in Table 2.1.  $H'$  should also be substituted for  $H$  in Table 3.2 when calculating layer depths.

2.35 It should be noted that this approximation will conservatively overestimate pore water pressures (since  $u = \gamma z r_u$ , where  $z$  is measured from  $H'$  instead of  $H$ ), but may unconservatively overestimate the effect of  $c'$  (since Wedge 1 appears to be sliding on a longer surface than it actually is). A small error is also introduced into the expression for  $W_1$ . These effects are summarised on Figure 2.15.



Flat base

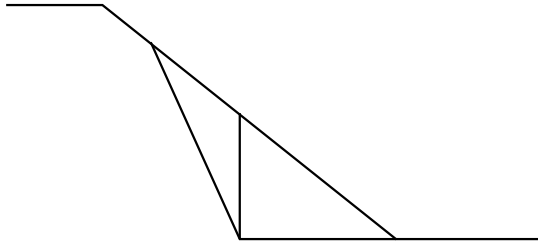

Sloping base

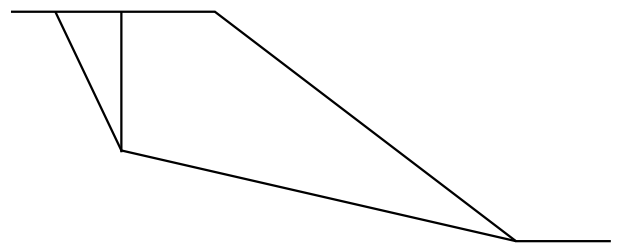
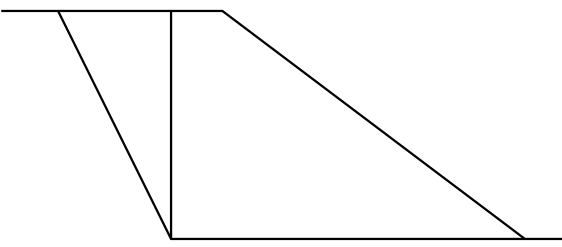
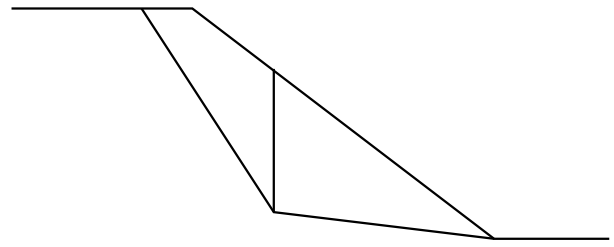
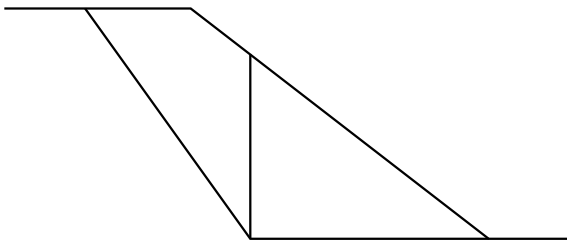
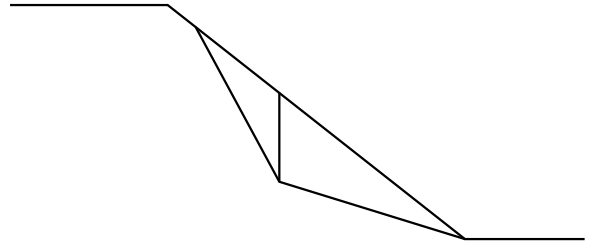

Figure 2.2 Examples of two-part wedge mechanisms

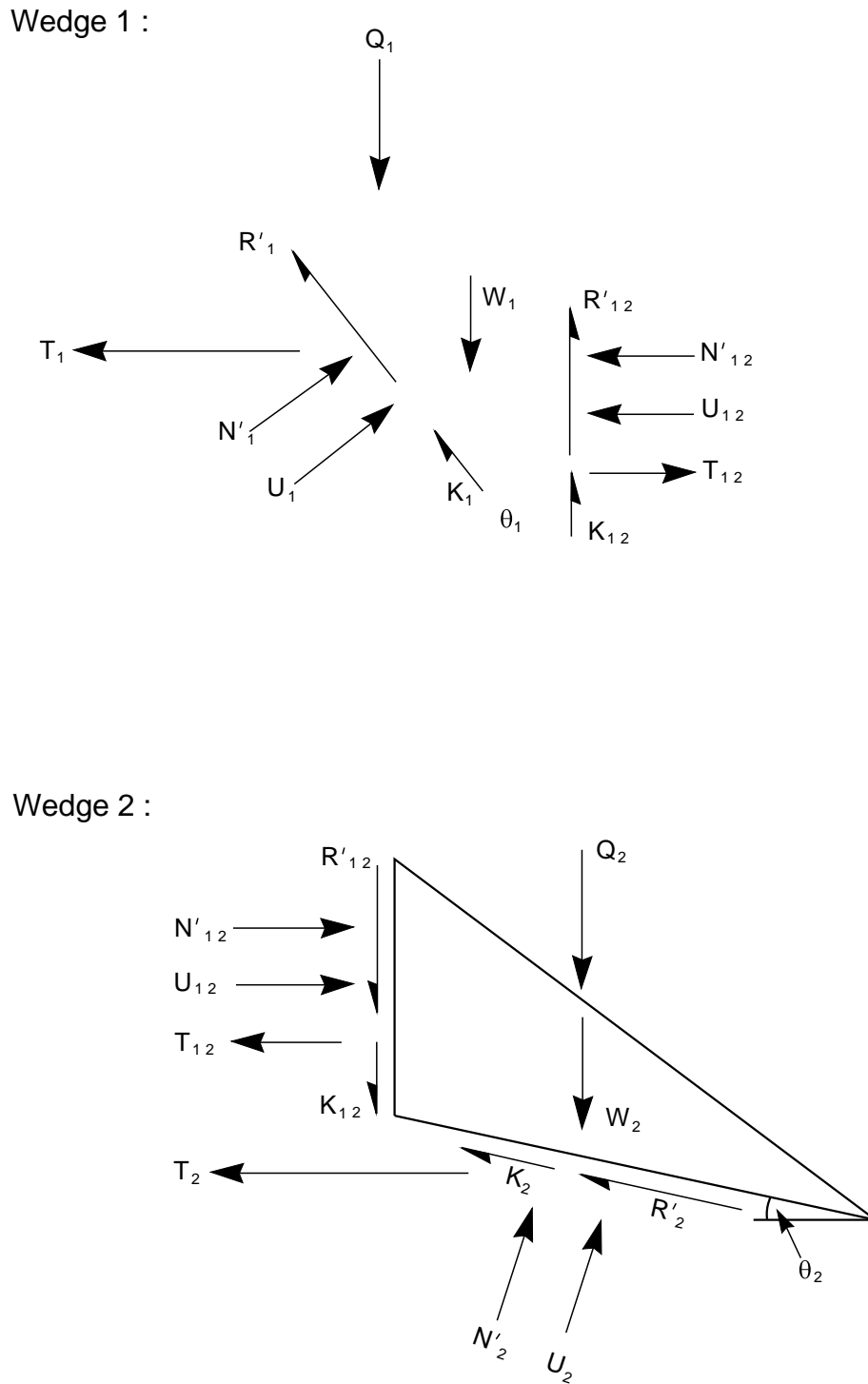
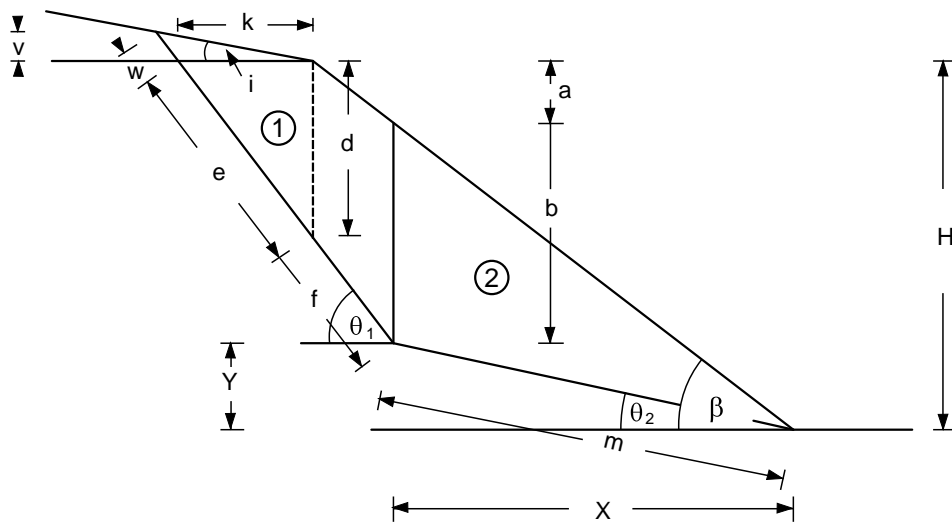
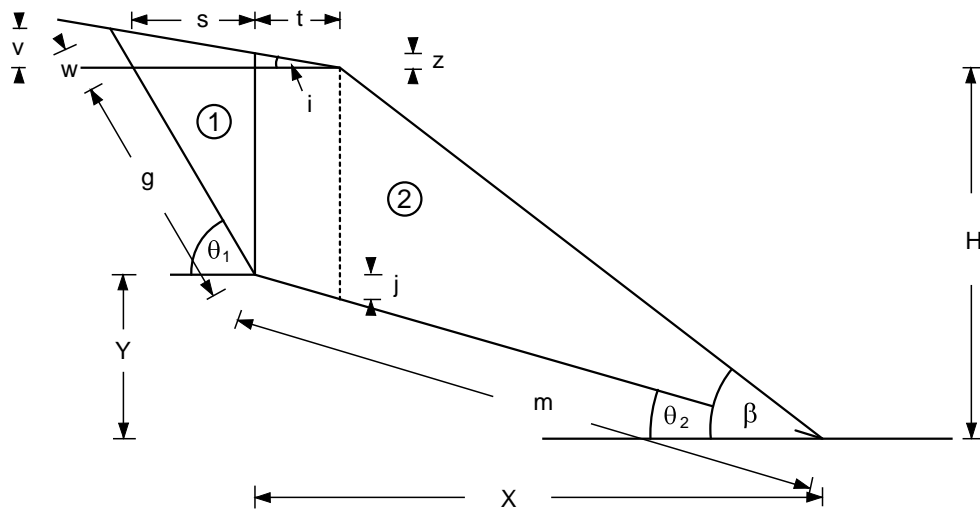

Figure 2.3 Forces acting on wedges

Case 1:



Case 2:



Case 3:

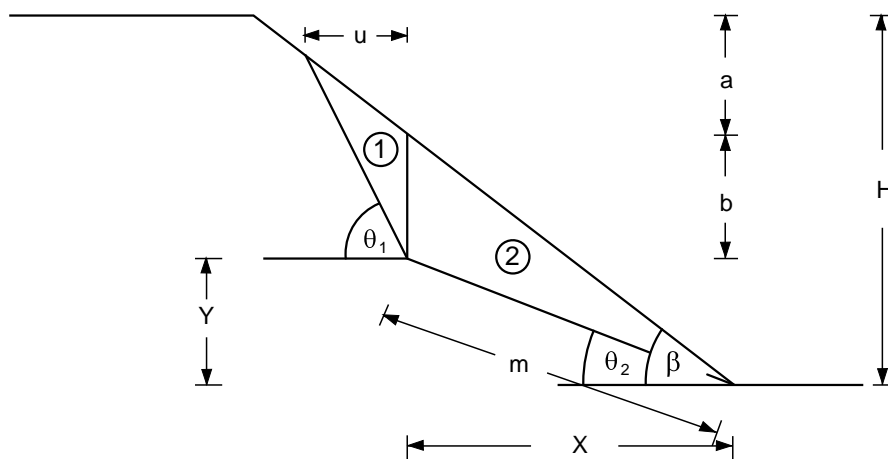

Figure 2.4 Definition of two-part wedge geometry for table 2.1 (3 cases)

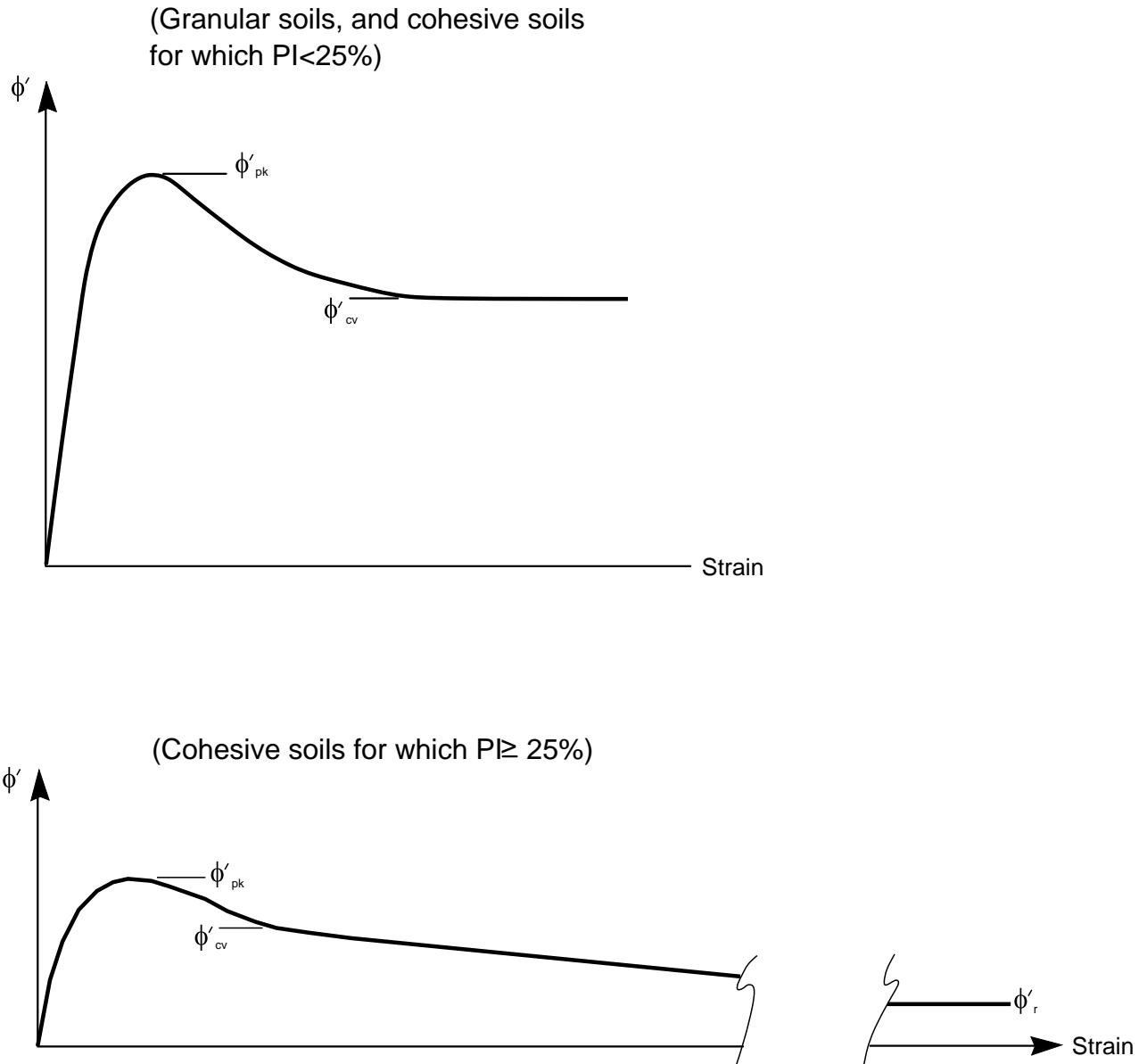
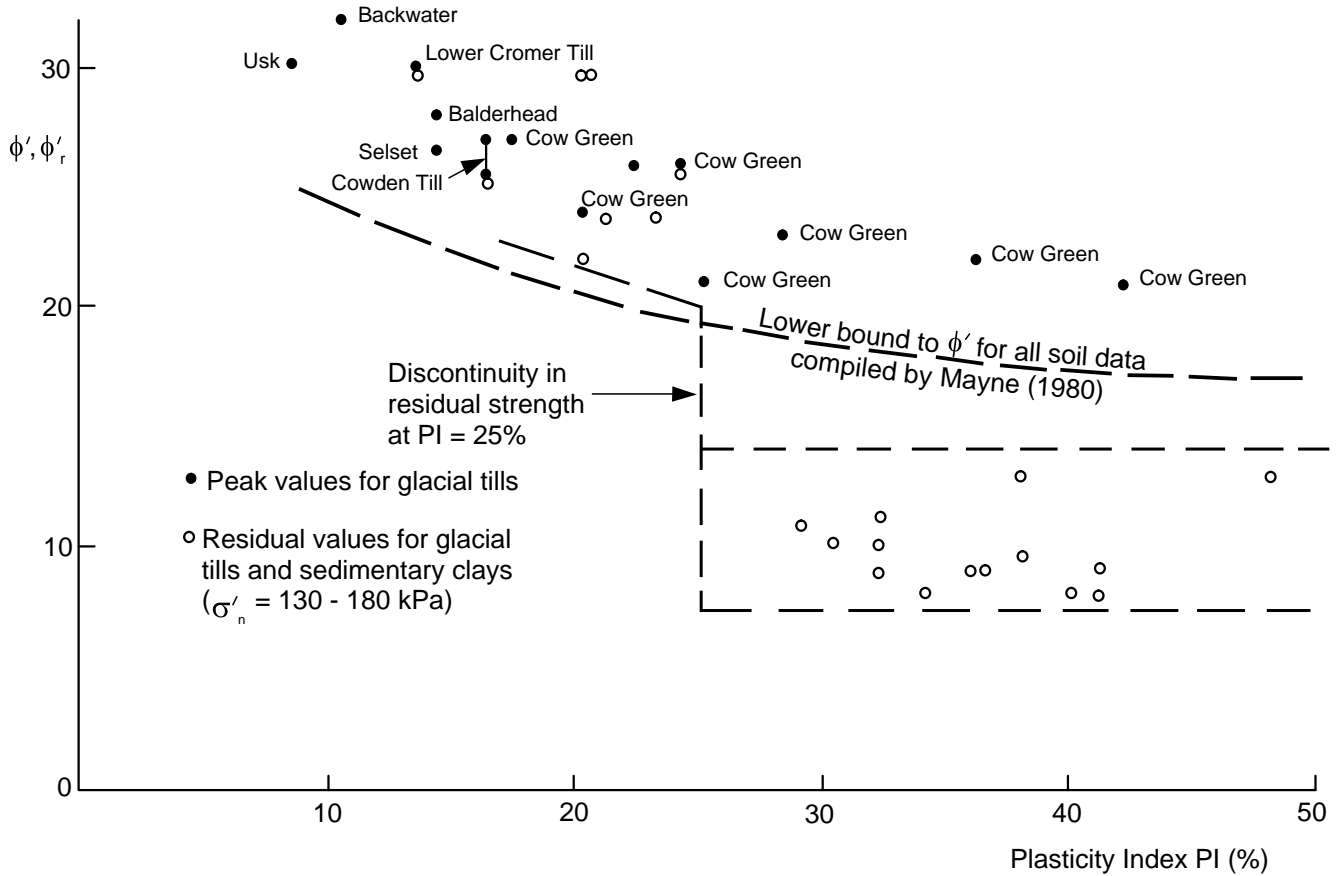

Figure 2.5 Variation of  $\phi'$  with displacement for two soil types





(from Hight, 1983)

Figure 2.6 Variation of  $\phi', \phi'_r$  with PI

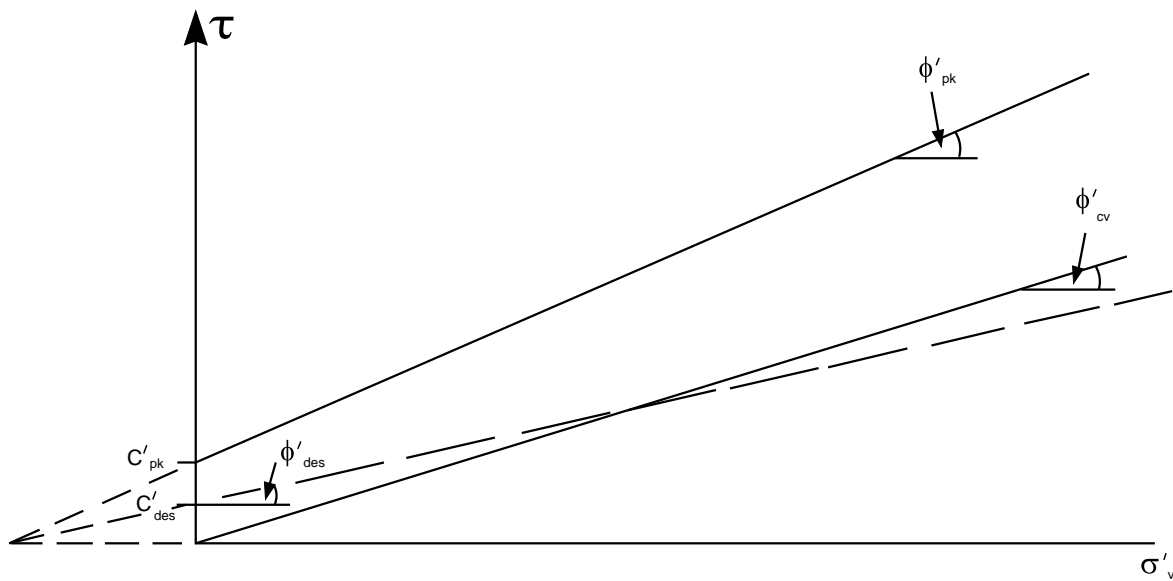

Figure 2.7 Comparison between "factored peak" soil strength parameters, and "critical state" values for the case of non-zero  $c'_{des}$

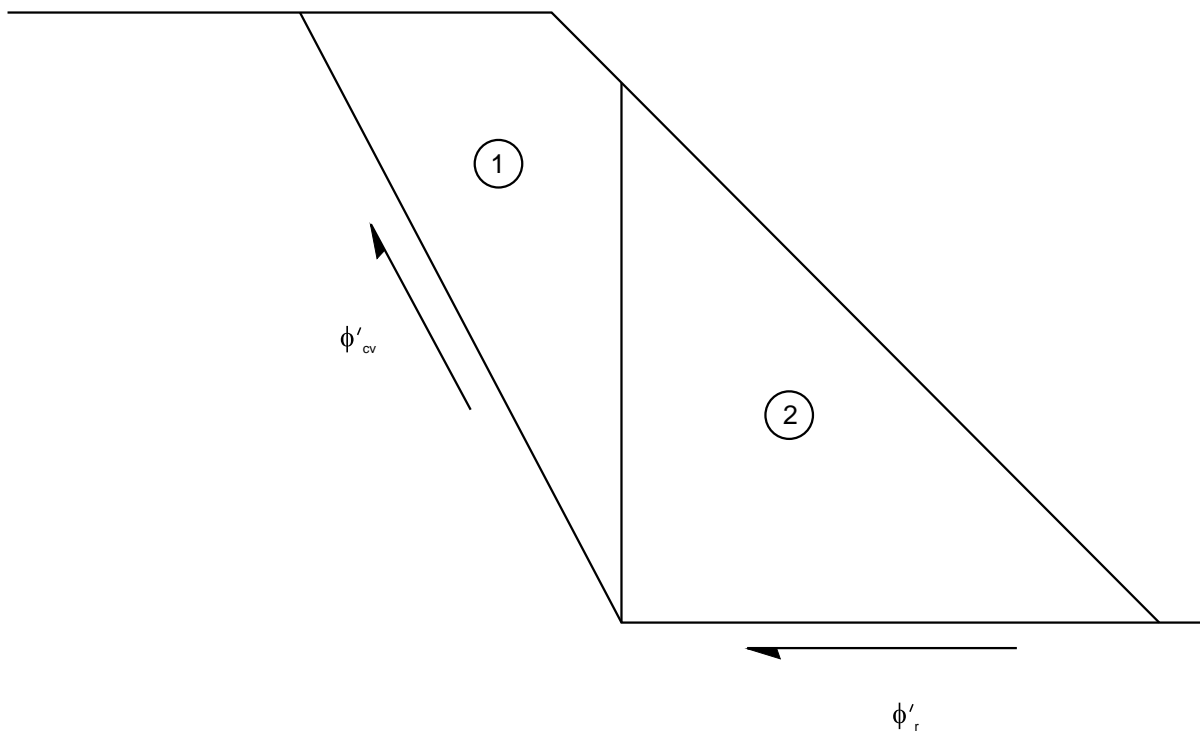
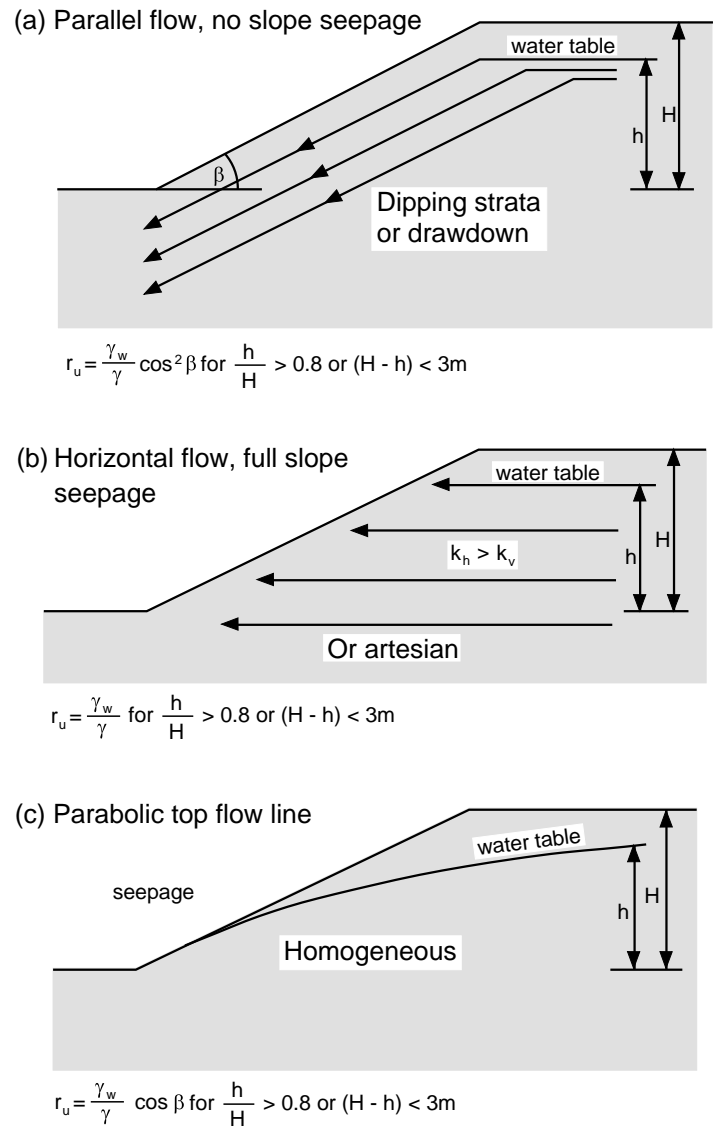

Figure 2.8 Different allocation of  $\phi'$  acting on wedge boundaries (high plasticity clays)



Ref: Mitchell (1983)

Figure 2.9 Values of  $r_u$  for typical flow conditions

a) Flow net

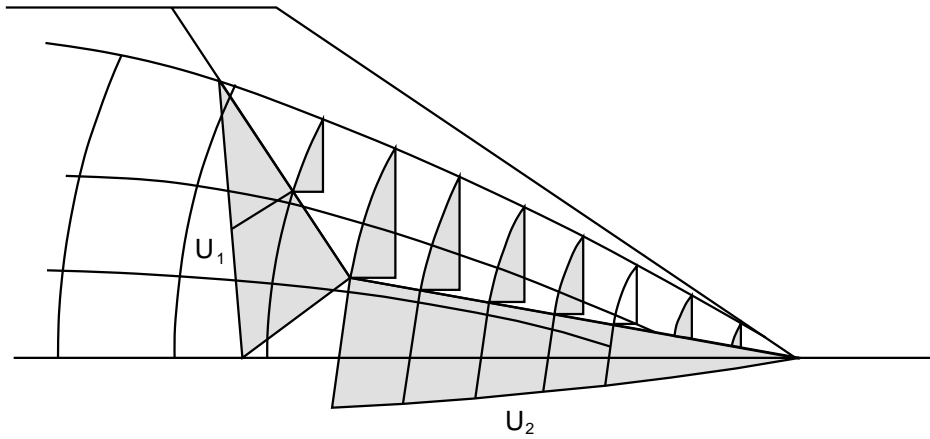

b)  $r_u$  approach ( $r_u \approx 0.3$ )

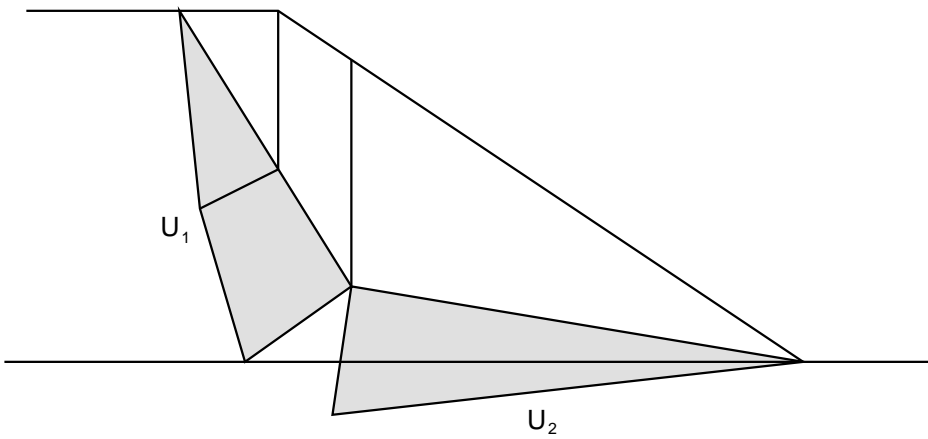

$$r_u = \frac{u}{\gamma h}$$

Figure 2.10 Comparison between typical flow net and  $r_u$  approach

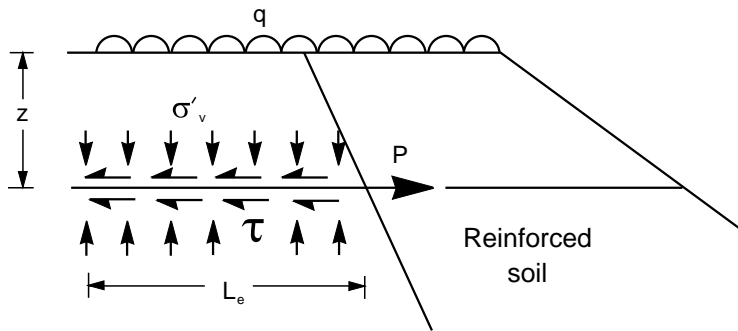

a) Soil reinforcement pull-out

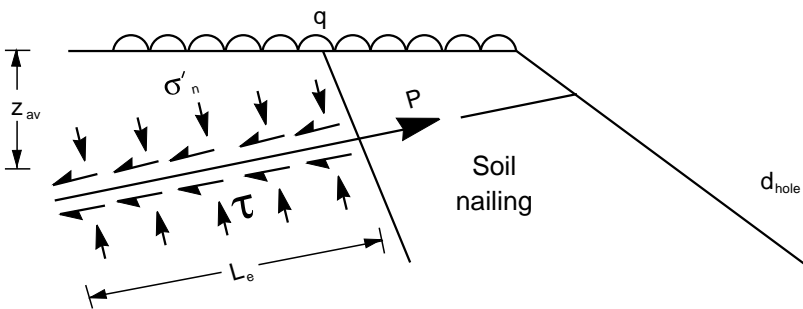
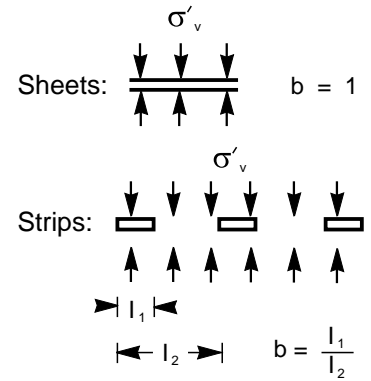

b) Soil nail pull-out

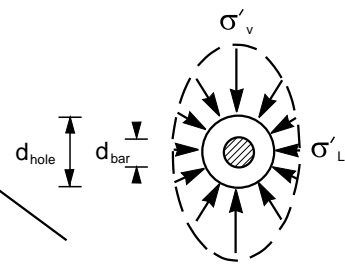

$$\sigma'_n = \frac{1}{2} (\sigma'_v + \sigma'_L)$$

$$\sigma'_L = K_L \sigma'_v$$

Figure 2.11 Pull-out details

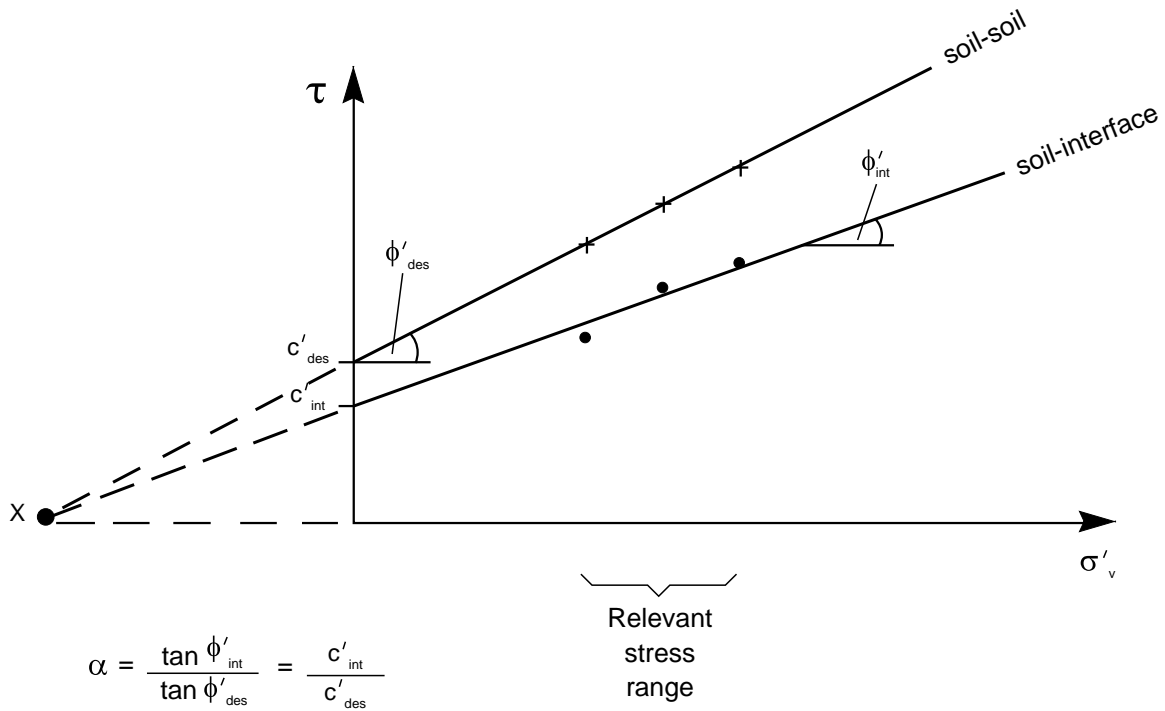

Figure 2.12 Construction to obtain  $\alpha$  for the case of non-zero cohesion

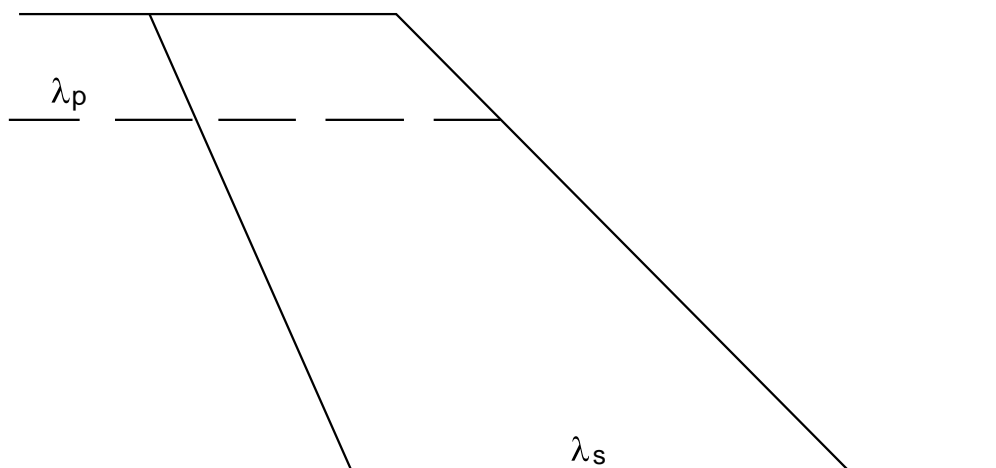
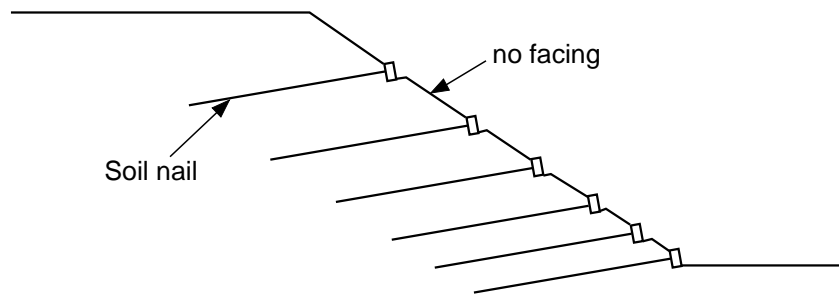
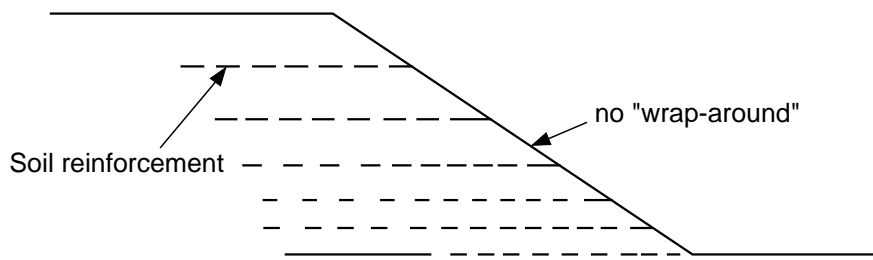

Figure 2.13 Pullout factor,  $\lambda_p$ , and Base sliding factor,  $\lambda_s$

a) No facing provided



b) Facing provided

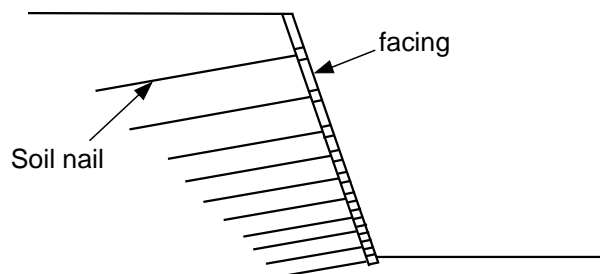
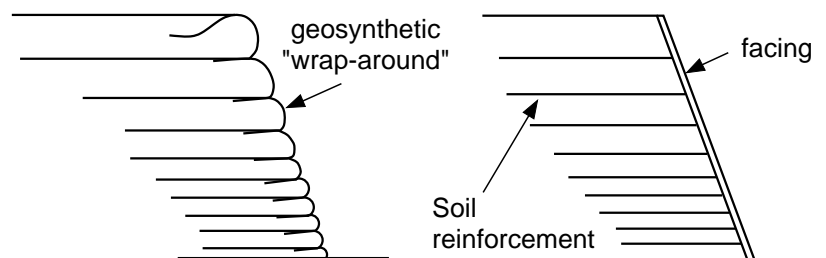
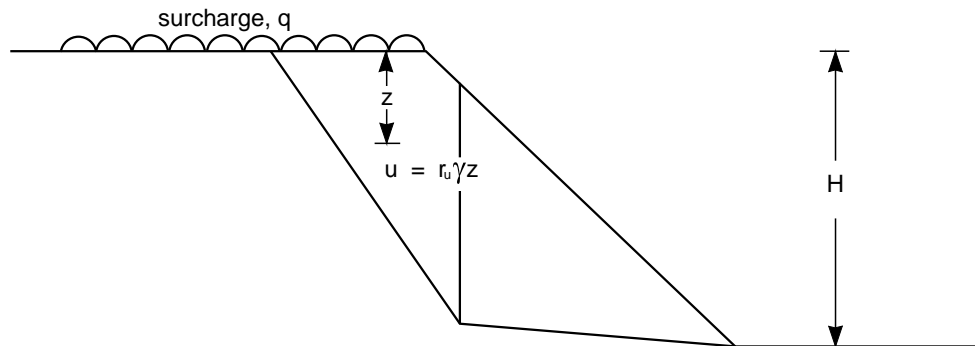
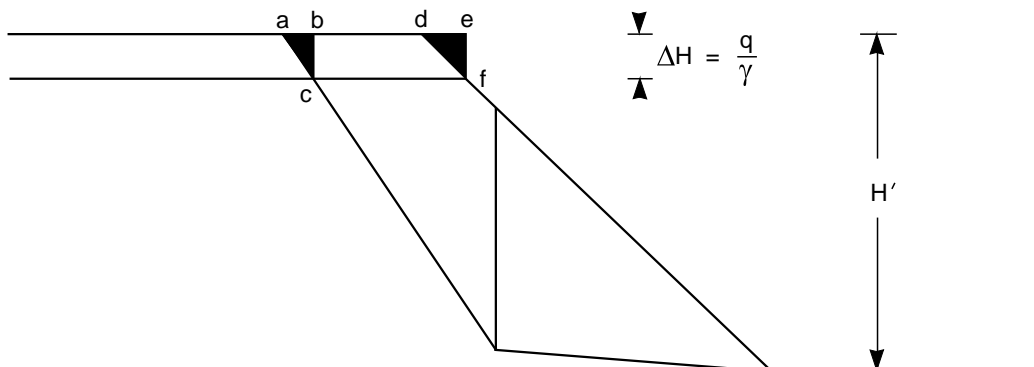

Figure 2.14 Front facing details

a) Actual case



b) Approximation



Errors:

1. Overestimation of  $K_f$  along  $\overline{ac}$ . (unconservative)
2. Overestimation of  $u$  by  $(r_v \gamma \Delta H)$ . (conservative)
3. Underestimation of surcharge loading by  $(def - abc)\gamma$ . (unconservative)

Figure 2.15 Consequences of surcharge approximation



**Table 2.1** Algebraic definitions (See Figure 2.4)

|       | Case 1  | Case 2  | Case 3                                  |
|-------|---|---|---|
| $W_1$ | $\frac{1}{2}\gamma[(a+b)^2\cot\theta_1 - a^2\cot\beta + v k]$ | $\frac{1}{2}\gamma(H-Y)^2\cot\theta_1 + \frac{1}{2}\gamma(v k - t z)$ | $\frac{1}{2}\gamma b u$                 |
| $W_2$ | $\frac{1}{2}\gamma b X$                                       | $\frac{1}{2}\gamma[2XH - X \tan\theta - H \cot\beta + t^2 z]$         | $\frac{1}{2}\gamma b X$                 |
| $U_1$ | $\frac{1}{2}r_u\gamma[d(e+w) + (d+b)f]$                       | $\frac{1}{2}r_u\gamma(g+w)(H-Y+z)$                                    | $\frac{1}{2}r_u\gamma b u \sec\theta_1$ |
| $U_2$ | $\frac{1}{2}r_u\gamma b m$                                    | $\frac{1}{2}r_u\gamma[(H-Y)(X+t)\sec\theta_1 + j m + zt\sec\theta_1]$ | $\frac{1}{2}r_u\gamma b m$              |
| $K_1$ | $c'_1(e + f + w) = c'_1(g + w)$                               | $c'_1(g + w)$   | $c'_1[u \sec\theta_1]$                  |
| $K_2$ | $c'_2 m$  | $c'_2 m$  | $c'_2 m$                                |
| $Q_1$ | $q(k + w \cos \theta_1)$                                      | $q(s + w \cos \theta_1)$  | Not applicable                          |
| $Q_2$ | Not applicable  | $q t$   | Not applicable                          |

|   |   |   |  |
|---|---|---|--|
| a | $(H - X \tan\beta)$                             | m | $\sqrt{(X + Y)}$   |
| b | $(H - Y - a) = X \tan\beta - Y$                 | s | $(a + b) \cot\theta$   |
| d | $k \tan\theta_1$                                | t | $(k - s)$  |
| e | $k \sec\theta_1$                                | u | $b/(\tan\theta - \tan\beta)$                                 |
| f | $[(a + b)/\sin\theta_1] - e = (g - e)$          | v | $k/(\cot\theta - \cot\theta_1)$ [if $i = 0$ , then $v = 0$ ] |
| g | $s \sec\theta_1 = (a + b)/\sin\theta_1$         | w | $v/\sin\theta_1$   |
| j | $t \tan\theta_2$                                | z | $t \tan\theta_1$   |
| k | $[(a+b)\cot\theta_1] - [a \cot\beta] = (s + t)$ |   |  |

Note: If surcharge is being treated as an equivalent additional thickness of fill, then substitute  $H'$  for  $H$  in the above, where  $H' = H + (q/\gamma)$ , and set  $Q_1 = Q_2 = 0$

# 3. DESIGN PROCEDURE FOR REINFORCING HIGHWAY SLOPES WITH HORIZONTAL REINFORCEMENT

## Introduction

3.1 The following chapter addresses the strengthening of embankment slopes using *horizontal* layers or strips of reinforcement, or using a combination of horizontal reinforcement and soil nailing (hybrid construction). An embankment slope for the purposes of this Advice Note is any slope (up to 70°) which is formed by the placement of fill material. Design of slopes solely stabilised by *inclined* reinforcement (soil nailing) is covered separately in Chapter 4, due to the added complexities introduced into the governing equations by the inclination of the reinforcement. The following three types of embankment slope are considered separately (see Figures 3.1 a, b and c, respectively):

- Type 1 - embankments built on horizontal ground
- Type 2 - embankments built onto existing shallower embankment slopes
- Type 3 - repair of slip failures

The two-part wedge mechanism defined in the previous section is used for the design of all three types of embankment slope, with the general concepts introduced below.

## General Concepts

3.2 In a reinforced soil slope, both the total reinforcement force (the number of reinforcement layers x strength per layer) and the overall dimensions of the zone containing reinforcement ( $L_T$  and  $L_B$ , see Figure 3.2a) must be set. These are governed by separate factors, and it is convenient to consider the following three general concepts:

### *The $T_{max}$ Mechanism*

3.3 In any slope it will be possible to identify (by a computer search or other means) the critical two-part wedge mechanism, which requires the greatest horizontal reinforcement force (i.e.  $T_{tot} =$

$T_{max}$ ). This critical mechanism is unique and will determine the total reinforcement force,  $T_{max}$ , required, and is called the " $T_{max}$  mechanism". The minimum

number of reinforcement layers,  $N$  required is given by  $T_{max} / P_{des}$ , rounded up to the next integer.

3.4 The  $T_{max}$  mechanism also governs the length of the reinforcement zone,  $L_T$  at the top of the slope (Figure 3.2b). The length  $L_T$  is set such that the uppermost reinforcement layer of the  $T_{max}$  mechanism has just sufficient length,  $L_{e1}$  to mobilise its full pull-out resistance.

It is useful to non-dimensionalise the value of  $T_{max}$ , using the parameter  $K$ , where:

$$K = T_{max} / (0.5 \gamma H^2)$$

(It should be noted that the value of  $K$  is not equivalent to the active Rankine coefficient,  $K_a$ )

3.5 For the special case of a two-part wedge mechanism with  $\theta_2 = 0$  where sliding of the lower wedge takes place over a horizontal layer of reinforcement, then the values of  $R_2'$  and  $K_2$  (Figure 2.3) should be reduced by the base sliding factor,  $\lambda_s$ . The effect of  $\lambda_s$  is already included in Equation 1, paragraph 2.9. Relevant values of  $\lambda_s$  may be found in paragraph 2.33 for different reinforcement types. [Note that when  $\theta_2 \neq 0$ , then  $\lambda_s$  always reverts to a value of unity.]

3.6 For convenience, a listing of  $T_{max}$  mechanisms (giving  $K$ ,  $X/H$ ,  $Y/H$  and  $\theta_1$ ) is provided in Table 3.1 for the case of  $c'_{des} = 0$ ,  $\lambda_s = 0.8$ ,  $i = 0$  and  $\theta_2 \geq 0$  (the value of  $\lambda_s$  only influencing mechanisms for which  $\theta_2 = 0$ ). These may be used directly, or used to calibrate computer programs based on Equation 1 given in paragraph 2.9 and the simple algebraic expressions given in Table 2.1.

### *The $T_{ob}$ Mechanism*

3.7 The  $T_{ob}$  mechanism defines the length  $L_B$  required for the reinforcement zone at the base. Since it is assumed that a competent bearing material exists beneath the reinforced zone, the key mechanism for the purposes of fixing  $L_B$  is forward sliding on the basal layer of reinforcement. This is called the  $T_{ob}$  mechanism.

3.8 More generally, the size of the reinforcement zone should be such that no two-part wedge mechanism

requiring reinforcement for stability can pass completely outside it. A two-part wedge mechanism requiring precisely zero reinforcement force for stability is called a " $T_0$  mechanism" (the lower wedge of such a mechanism effectively representing a gravity retaining wall which would be just stable). As shown in Figure 3.2c, there are numerous  $T_0$  mechanisms. These are bounded by a " $T_0$  locus" (the locus corresponding to the position of the node X,Y of the  $T_0$  mechanisms) beyond which no further  $T_0$  mechanisms exist. It is convenient to consider the  $T_0$  mechanism at the point where the  $T_0$  locus intersects the base. This  $T_0$  mechanism, which incorporates horizontal sliding on the base, is termed the " $T_{ob}$  mechanism". The  $T_{ob}$  mechanism is simple to define and locate by computer search or otherwise. The critical value of  $\phi_1$ , for the  $T_{ob}$  mechanism may normally be assumed to be  $(\Pi/4 + \phi_{des}/2)$ , unless  $i > 0$  or  $X < H/\tan\beta$  when a special search should be made for  $\phi_1$ . The length  $L_B$  is set equal to the base width of the  $T_{ob}$  mechanism (Figure 3.2c). Since  $\theta_2 = 0$  for the  $T_{ob}$  mechanism (by definition), the value of  $\lambda_s$  given in paragraph 2.33 should be used in the general equation (Equation 1, paragraph 2.9). For convenience, a listing of values for  $L_B$  are given in Table 3.1 for the case of  $c'_{des} = 0$ ,  $\lambda_s = 0.8$  and  $i = 0$ . In the few situations where  $X < H/\tan\beta$  then a special search should be made for the critical value of  $\theta_1$ .

### Optimum Vertical Spacing

3.9 In order to prevent the onset of progressive failure, limit equilibrium must be satisfied not only on a global basis (ie external equilibrium) but also on a local basis (ie internal equilibrium). In order to prevent any single layer of reinforcement becoming overstressed locally (Figure 3.3) and possible progressive failure, it may be shown (Appendix F) that the maximum vertical spacing,  $S_v$ , of equal strength layers of reinforcement should be limited to:

$$S_v = P_{des} / K \gamma z$$

where  $z$  is the depth to the mid-point between layers (see Figure 3.3).

3.10 There is also the need to preserve geometrical similarity at all points up the slope, in order to satisfy reduced-scale  $T_{max}$  mechanisms which outcrop on the front face. It is shown in Appendix F that this requirement is satisfied by the following expression for optimum layer spacings (assuming that all layers of reinforcement have identical capacity,  $T_{max}/N$ ):

$$z_i = H \sqrt{(i-1)/N}$$

where  $z_i$  = depth below crest level to  $i^{th}$  layer  
 $H$  = height of embankment  
 $N$  = total number of reinforcement layers

3.11 The exception to the above rule is the uppermost layer of reinforcement. Theoretically the top layer of reinforcement should be inserted at zero depth, but for slopes with a horizontal upper surface (i.e.  $i = 0$ ) this would then result in zero pull-out strength. It is recommended that the first layer of reinforcement be inserted at a depth,  $z_1 = 0.5 z_2$  in such cases. For the case of sloping backfills (i.e.  $i > 0$ ) the first layer may be positioned anywhere between 0 and  $0.5 z_2$ .

3.12 It is noted that, since the  $(N + 1)^{th}$  layer of reinforcement is inserted at a depth of  $H$ , there will always in fact be  $(N + 1)$  layers of reinforcement provided, rather than  $N$ . This extra layer of reinforcement is not a source of over-design, however, as discussed in Appendix G.

3.13 Values for the optimum layer depths are tabulated in non-dimensional form in Table 3.2 for the case of uniform reinforcement rupture strength (and are seen to be independent of  $\beta$  and  $\phi'$ ). For the case of non-uniform reinforcement rupture strength with depth, see the general requirement given in Appendix F.

3.14 For the case of limited surcharge, the value of  $H'$  ( $= H + q/\gamma$ ) should be used in the equation instead of  $H$ , and values of  $z_i$  should be measured from  $H'$ , rather than from the actual top of the slope,  $H$  (see Figure 3.4). The surcharge should be limited to  $\Delta H = z_1$ .

### Practical Vertical Spacing

3.15 While the above optimum layer depths represent the layout for the minimum required reinforcement, the resulting layer spacings are not constant with depth. Although not necessary, it may be desirable to rationalise the spacings into simple multiples of a practical compaction layer thickness (although this will lead to a greater total quantity of reinforcement being used). Any practical layer spacing arrangement may be adopted

provided that both of the simple rules below are satisfied:

- the depth to the  $i^{\text{th}}$  layer of reinforcement anywhere in the slope does not exceed the value of  $z_i$  given in Table 3.2
- the spacing between layers at any depth should not exceed  $P_{\text{des}}/K\gamma z$ , where  $z$  is the depth to the middle of the spacing.

*Checks*

- 3.18 The following checks should be carried out as appropriate:
- i. It is likely that for most practical design cases, if the dimensions  $L_T$  and  $L_B$  are set as above and the layer depths and vertical spacings satisfy Table 3.2, then all possible intermediate two-part wedge mechanisms will be adequately catered for. However, intermediate mechanisms (Appendix G) may need to be checked in certain cases.
  - ii. In cases where geosynthetic reinforcement is not "wrapped around" at the front face (as may be the case for shallower slopes with  $c'_{\text{des}} > 0$ ), front face pull-out should be checked (see Appendix E). It is also likely that an increased value of  $L_T$  will be required in this instance (see Appendix G).
  - iii. Check that  $L_B$  allows sufficient pull-out length on the bottom length of reinforcement from the  $T_{\text{max}}$  mechanism, and if not, extend  $L_B$  accordingly. (This is only likely to be critical for reinforcement requiring long pull-out lengths, eg strip reinforcement with low  $b$  value).
  - iv. The assumption of a competent bearing material beneath the embankment slope should be reviewed and, if necessary, underlying slip mechanisms checked (see Appendix B). It should be noted that the mechanisms provided in Table 3.1 are for  $\theta_2 \geq 0$  only.
  - v. Check displacements, serviceability, and compatibility between stiffness of reinforcement and of soil (paragraphs 3.29 to 3.34). Consider also the possible effects of expansion of the soil due to swelling or freezing.
  - vi. Check that drainage measures are compatible with the pore water pressures assumed. Consider also the potential effects of water filled tension cracks forming behind the reinforced zone.
  - vii. Check provision for protection against ultra-violet radiation, fire and vandalism and for establishment of vegetation.

**Design of Embankments Built on Horizontal Ground**

*Type 1 Embankment*

3.16 A preliminary estimate of the total quantity of reinforcement and layout required to support an embankment slope (angle  $\beta$ , soil parameters  $\phi'_{\text{des}}$ ,  $c'_{\text{des}}$ ,  $\gamma$ , and pore pressure parameter  $r_u$ ) of the type shown in Figure 3.1a constructed over horizontal ground may be arrived at by the following basic procedure.

*Basic Procedure*

3.17 The steps in the basic procedure are as follows:

- i. Perform computer searches (based on equation 1, paragraph 2.9) for the  $T_{\text{max}}$  and  $T_{\text{ob}}$  mechanisms, using the appropriate value of  $\lambda_s$ .
- ii. Choose  $P_{\text{des}}$  (paragraph 2.20) and calculate  $N$ , rounded up to the next integer (where  $N = T_{\text{max}} / P_{\text{des}}$ ). Calculate the depth,  $z_1$  to the first layer of reinforcement using Table 3.2. Calculate the pull-out length,  $L_{e1}$  required on the first layer of reinforcement (paragraph 2.23).
- iii. Draw the  $T_{\text{max}}$  and  $T_{\text{ob}}$  mechanisms on the slope section. Mark on  $L_{e1}$  and read off  $L_T$  and  $L_B$ , as shown on Figure 3.2. (If  $L_T$  is less than  $[L_B - X_c]$ , where  $X_c = H/\tan\beta$ , then  $L_T$  should be set equal to  $[L_B - X_c]$ , so that the rear boundary of the reinforcement zone becomes vertical.) Draw on all other reinforcement layers based on spacings given in Table 3.2.

Worked examples Nos 1 and 2 demonstrate the above procedure for determining a preliminary estimate of the reinforcement requirement. This should then be checked.

**Embankment Slopes Built onto Existing Shallow Embankment Slopes****Type 2 Embankment**

3.19 The case of embankment slopes being constructed onto existing shallow embankment slopes is becoming increasingly common on highway widening schemes (Figure 3.1b). It forms a special case of soil reinforcement, since the zone for horizontal placement of reinforcement reduces at the toe of the slope. If no further land-take is acceptable beyond the toe of the existing embankment, then either some excavation into the existing embankment will be necessary (Figure 3.5a), or an alternative means of stabilising the existing embankment will need to be undertaken, such as a hybrid construction involving both soil reinforcement and soil nailing (Figure 3.5b). (It should be noted that Figure 3.5b is diagrammatic only, and that in practice it would be beneficial to form benches in the existing slope to avoid a plane of weakness at the interface.)

3.20 It is not viable simply to pack in a lot of reinforcement into the new fill area, because underlying mechanisms will often exist below the new fill area (Figure 3.6), nor would it be economic on total quantity of reinforcement; more than  $T_{max}$  would be required since the reinforcement in the lower part of the fill area would not count towards the  $T_{max}$  mechanism.

3.21 In the case of a hybrid construction with both reinforced soil and soil nailing zones (Figure 3.5b), the layers or strips of reinforcement in the new fill material may be mechanically fixed to, or overlap with the soil nails installed into the existing embankment fill in benches (Figure 3.5c). The hybrid option may be designed according to the basic procedure and the checks given in paragraphs 3.16 to 3.18, with the following special measures.

**Special Measures**

3.22 The special measures for hybrid construction are as follows:

- i. The most critical of the two embankment fill soil parameters should be used for the  $T_{max}$  mechanism.

- ii. For ease of construction and the formation of joints, the vertical spacing of the nails should match that of the horizontal soil reinforcement layers. The value of  $P_{des}$  (in terms of *rupture strength*, paragraphs 2.19 to 2.22) of the nails should be made at least equivalent by adjusting  $d_{hole}$  and  $S_h$  of the nails.

If the pull-out resistance per metre length of nail ( $P_{des}/L_c$ ) is also approximately equivalent to the horizontal soil reinforcement, and the nails are approximately horizontal, then the boundaries set by  $L_T$  and  $L_B$  for the horizontal soil reinforcement in Figure 3.5a would also apply to the soil nailing (see Figure 3.7a). As the soil nails are likely to be inclined (for reasons of grout control), the procedure to be followed for inclined soil nails is set out in Appendix H.

- iii. The respective values of  $\lambda_s$ ,  $\lambda_p$  should be used in the soil nailing and the reinforced soil zones. Generally the soil nails will control  $L_B$  and the reinforced soil will control  $L_T$ .

3.23 Worked example No 4 demonstrates the procedure for obtaining a preliminary estimate of the reinforcement required. Short term stability of the hybrid should then be checked. Some typical slip-circle failure mechanisms are shown in Figure 3.8. This may be more critical than the long term situation, for example in the case of an existing clay embankment where the undrained shear strength near the existing embankment surface may be relatively low. It is recommended that the pull-out strength of nails assumed for short term stability calculations be based on carefully conducted short term pull-out tests done in situ.

**Repair of Slip Failures****Type 3 Embankment**

3.24 The repair of a failed slope (Figure 3.1c) employing soil reinforcement may be carried out by applying the basic procedure and checks given in paragraphs 3.16 to 3.18 (and the special measures in paragraphs 3.19 to 3.23 if soil nailing is used in conjunction with reinforced soil), with the additional step of back-analysis. Worked example No 5 demonstrates how a preliminary estimate of the reinforcement required may be obtained.

*Back-analysis of Slip Failure*

3.25 From the geometry of the failure surface and the likely value of  $r_u$  acting at the time of the failure, the soil strength parameters for the slope should be back-analysed. The mechanism used for the back-analysis should also be based on the two-part wedge mechanism defined in Chapter 2 in order to obtain compatible soil parameters. The overall factor of safety should be taken to be unity for the back-analysis exercise. Since a large majority of recent highway slips have occurred in cuttings constructed in stiff high plasticity clays, the development of pre-existing shear planes should be checked and assessed.

*Reconstruction*

3.26 Redesign should then be based on the basic procedure and checks given in paragraphs 3.16 to 3.23 using the soil parameters obtained from the back-analysis exercise, factored by a small amount (eg  $f_s = 1.1$ ), to cover possible uncertainties during back-analysis.

3.27 The zone of reinforcement required to reconstruct the slope to its original profile, using the design steps contained in this Advice Note and the long-term value of  $r_u$ , is likely to extend significantly beyond the original slip surface (Figure 3.9a). This will prevent future failure on more deep-seated slip surfaces, the original slip probably having occurred in the superficial layers or where the advancing front of equilibrating pore water pressures had reached at the time. Because substantial extra excavation will be required to provide the necessary soil reinforcement lengths, a hybrid of soil nailing and reinforced soil, in the manner described in paragraphs 3.19 to 3.23 and Appendix H, may be more efficient.

3.28 An alternative to extensive excavation or soil nailing, may be to construct a berm at the toe of the slope to minimise the zone of reinforcement required (Figure 3.9b). In this case the individual reinforcement requirements for both the upper and lower slopes (Figure 3.9b) should be assessed separately in addition to the requirements of the overall slope. In the assessment for the overall slope, the extra weight of soil represented by the berm, ABC, may simply be added to the expression for  $W_2$  in Table 2.1 for the purposes of obtaining the  $T_{max}$  and  $T_{ob}$  mechanisms. The total reinforcement required will be given by the envelope from the three analyses (Figure 3.9b).

**Front Face Displacements**

3.29 An estimate of the displacement at the front face of the slope due to elongation of the reinforcement may be made by assuming the profile of tension along each reinforcement layer is as given in Figure 3.10. A uniform tension,  $P_{mob}$  should be assumed to occur along the length of reinforcement lying within the  $T_{max}$  mechanism, which then decreases linearly to zero by the rear boundary of the reinforced soil zone.

3.30 The value of  $P_{mob}$  will be less than  $P_{des}$  due to the soil almost certainly possessing a greater angle of friction than  $\phi'_{cv}$ ; the compatibility curve shown on Figure 3.11 demonstrates that the in-service reinforcement force,  $P_{mob}$  is likely to be less than  $P_{des}$  as a result of the peak behaviour of the soil strength. If both soil and reinforcement load-displacement data are available to plot Figure 3.11 reliably, then an estimate of  $P_{mob}$  may be obtained for displacement calculations. Otherwise, a relatively conservative estimate of displacements may be obtained by assuming that  $P_{mob} = P_{des}$ .

3.31 Other sources of horizontal movement will be deformation caused by the unreinforced soil behind the reinforced zone and the apparent deformation caused by incremental construction. These may be assumed to be relatively small if extensible reinforcement is used and the front face of each layer of fill is well restrained during construction.

*Free-draining Materials*

3.32 For free draining materials, the horizontal elongation,  $\delta_{ho}$  of a layer of reinforcement at the end of construction is given by:

$$\delta_{ho} = P_{mob} (x_1 + 0.5x_2) / J_o$$

where  $J_o =$  stiffness of reinforcement at end of construction (kN/m)  
 $x_1, x_2 =$  lengths defined on Figure 3.10

3.33 The reinforcement stiffness is likely to decrease with time after construction for visco-elastic polymer reinforcement. The extra horizontal displacement of the front face of the slope after construction,  $\Delta\delta_{ho}$  is then given by:

$$\Delta\delta_{ho} = \delta_{ho} (J_o / J_{\infty} - 1)$$

where  $J_{\infty}$  = stiffness of reinforcement at end of design life (kN/m)

#### *Non-free Draining Materials*

3.34 If the fill material used is not free draining and possesses significant cohesion in the short term, both the magnitude of the end-of-construction displacement,  $\delta_{ho}$  and the subsequent extra displacement in the longer term,  $\Delta\delta_{ho}$  will not only depend on the changing value of  $J$ , but also the changing value of  $P_{mob}$  in the formula above. The end-of-construction value of  $P_{mob}$  should be calculated assuming short term soil strength parameters (or alternatively using effective stress parameters with a negative  $r_u$  value). The long-term value of  $P_{mob}$  should be calculated assuming the long term values of  $\phi'$ ,  $c'$ , and  $r_u$ .

a) Type 1 New embankment

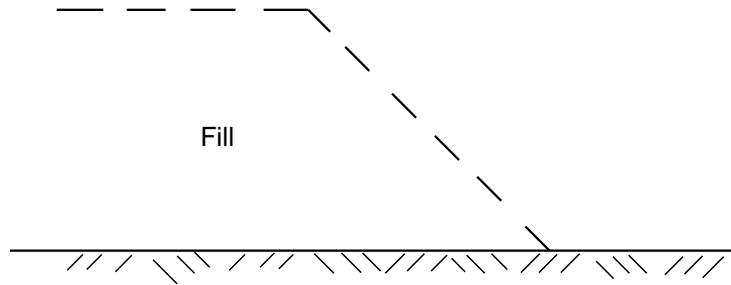

b) Type 2 Extension of existing slope

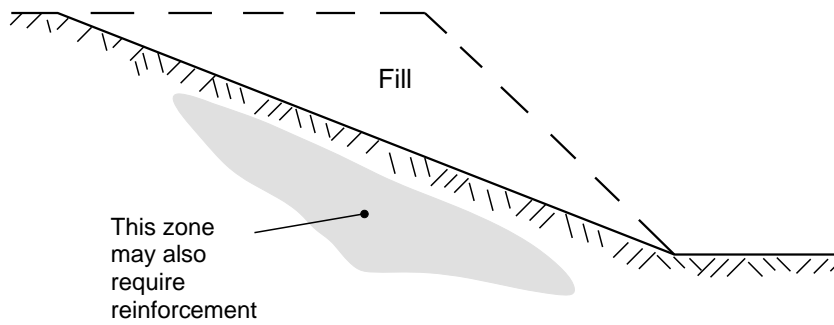

c) Type 3 Repair of slip failure

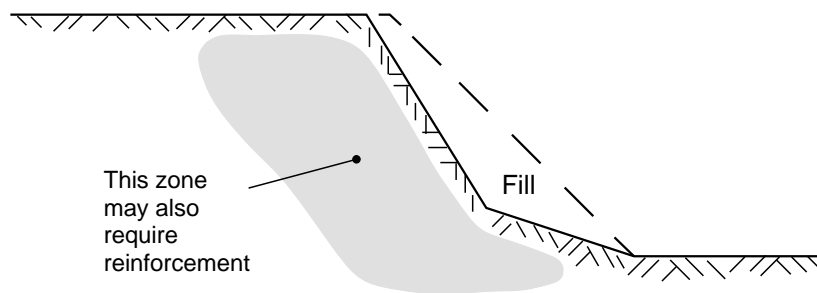

Figure 3.1 Sketches of embankment types



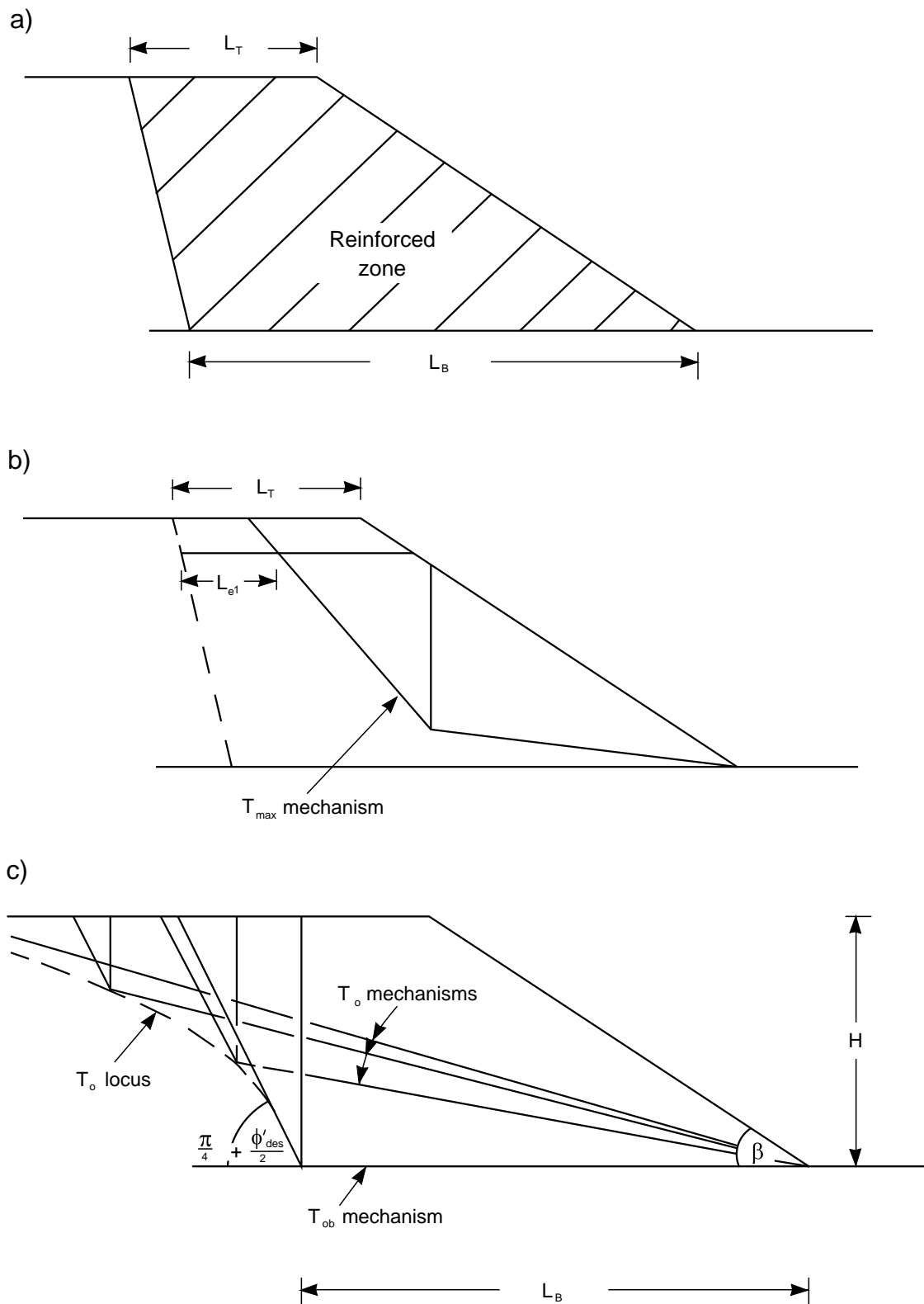
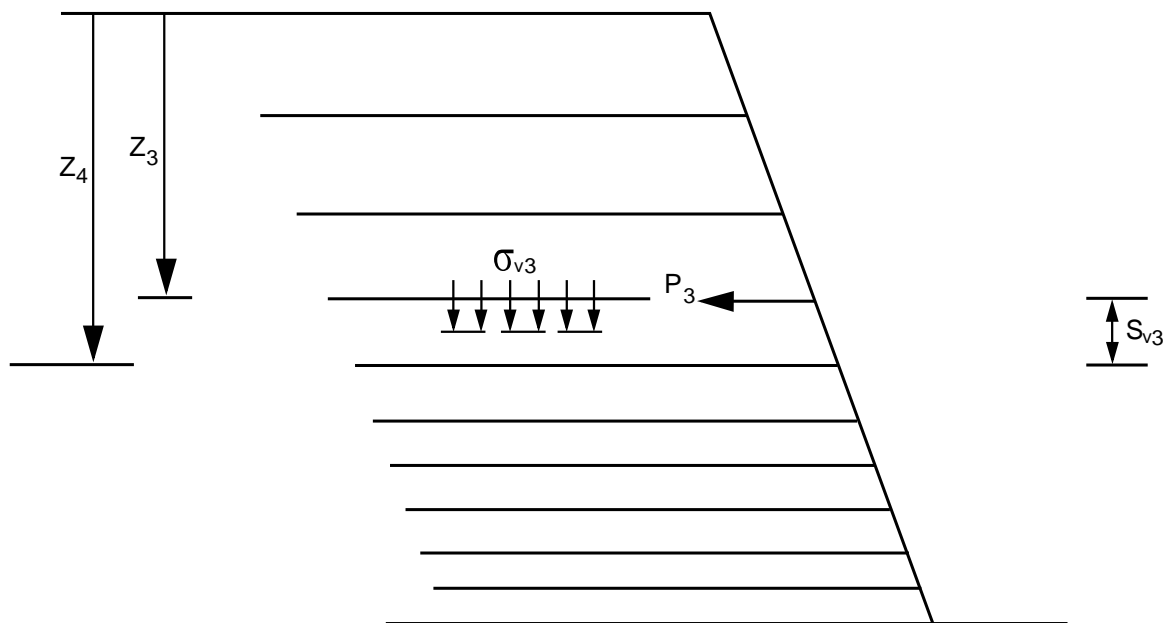

Figure 3.2 General concepts of design method for horizontal reinforcement



$$P_3 = \frac{1}{2} \gamma K (z_4^2 - z_3^2)$$

$$= \sigma_{v3} K S_{v3}$$

Figure 3.3 Local Equilibrium

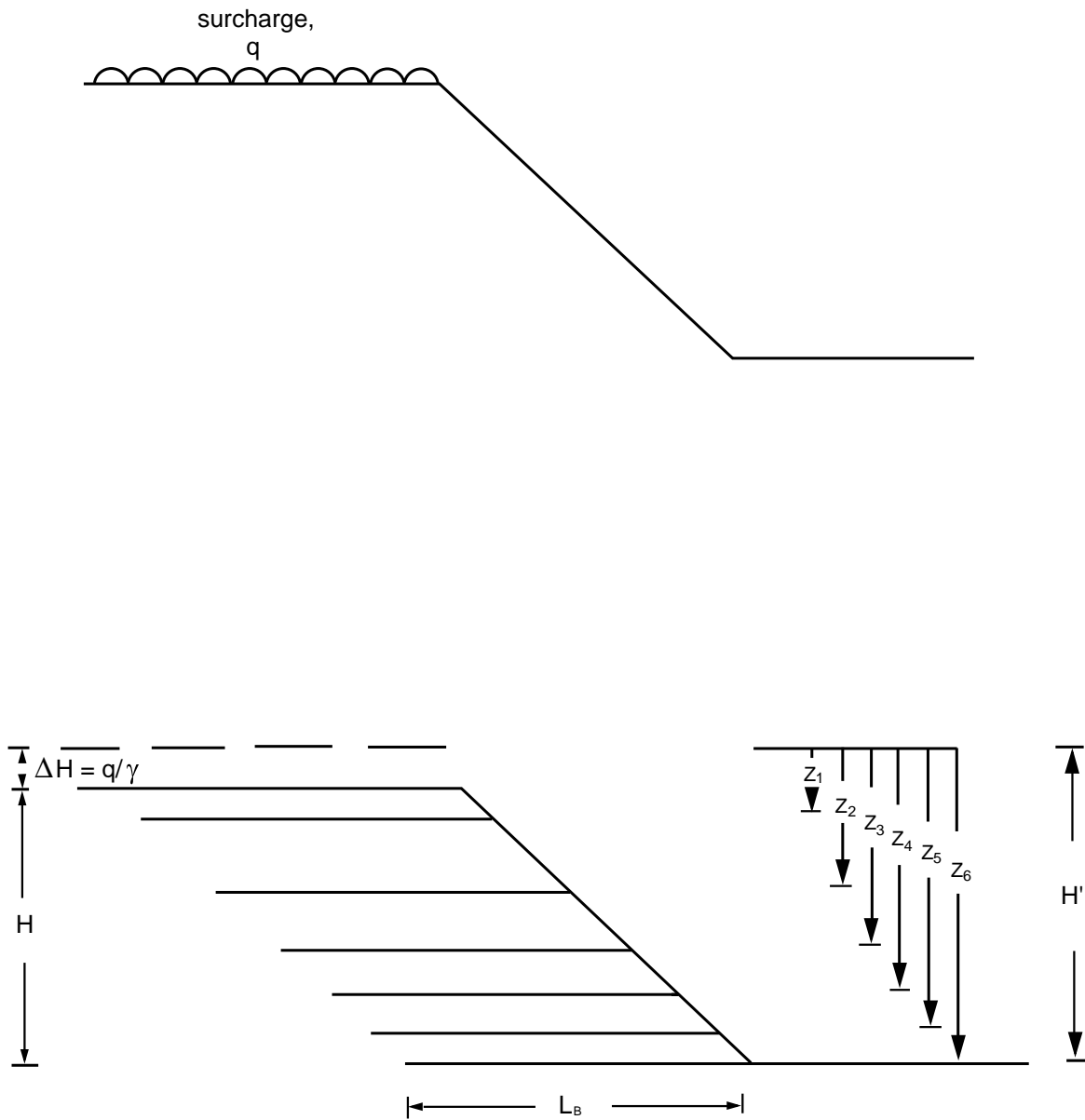

(Note; Use  $H'$  to obtain  $L_B$  from Table 3.1)

Figure 3.4 Consequences of surcharge

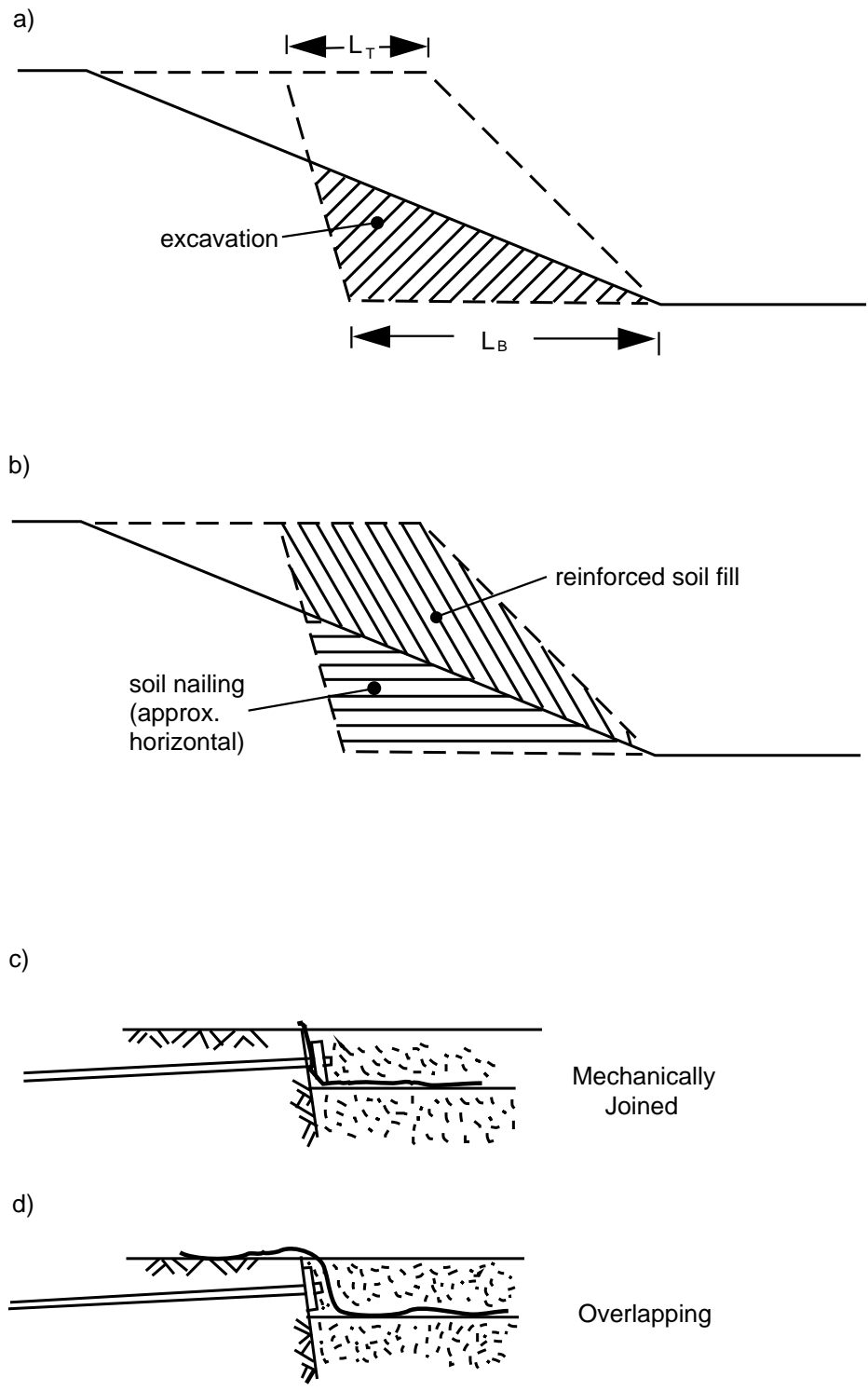

Figure 3.5 Details of Type 2 embankment including hybrid construction

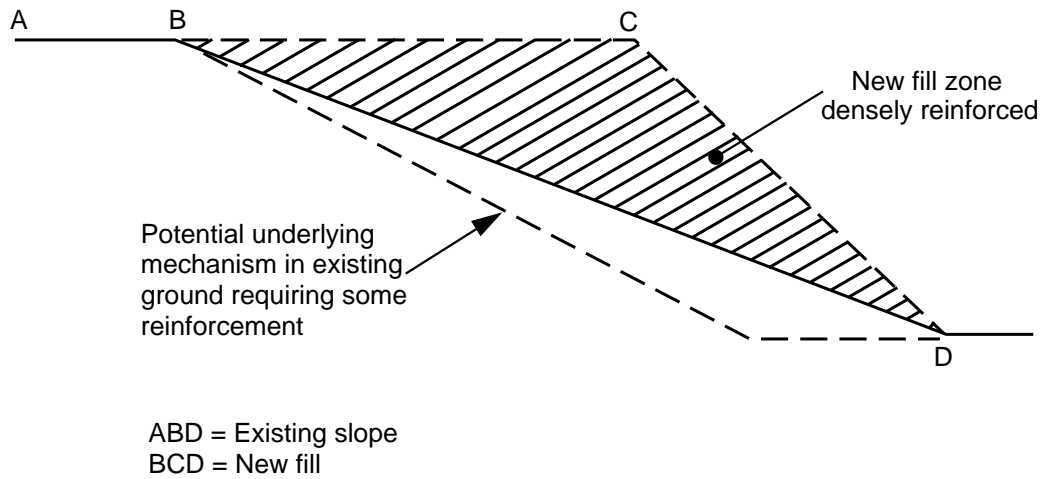

Figure 3.6 Embankment widening: Potential underlying failure mechanisms

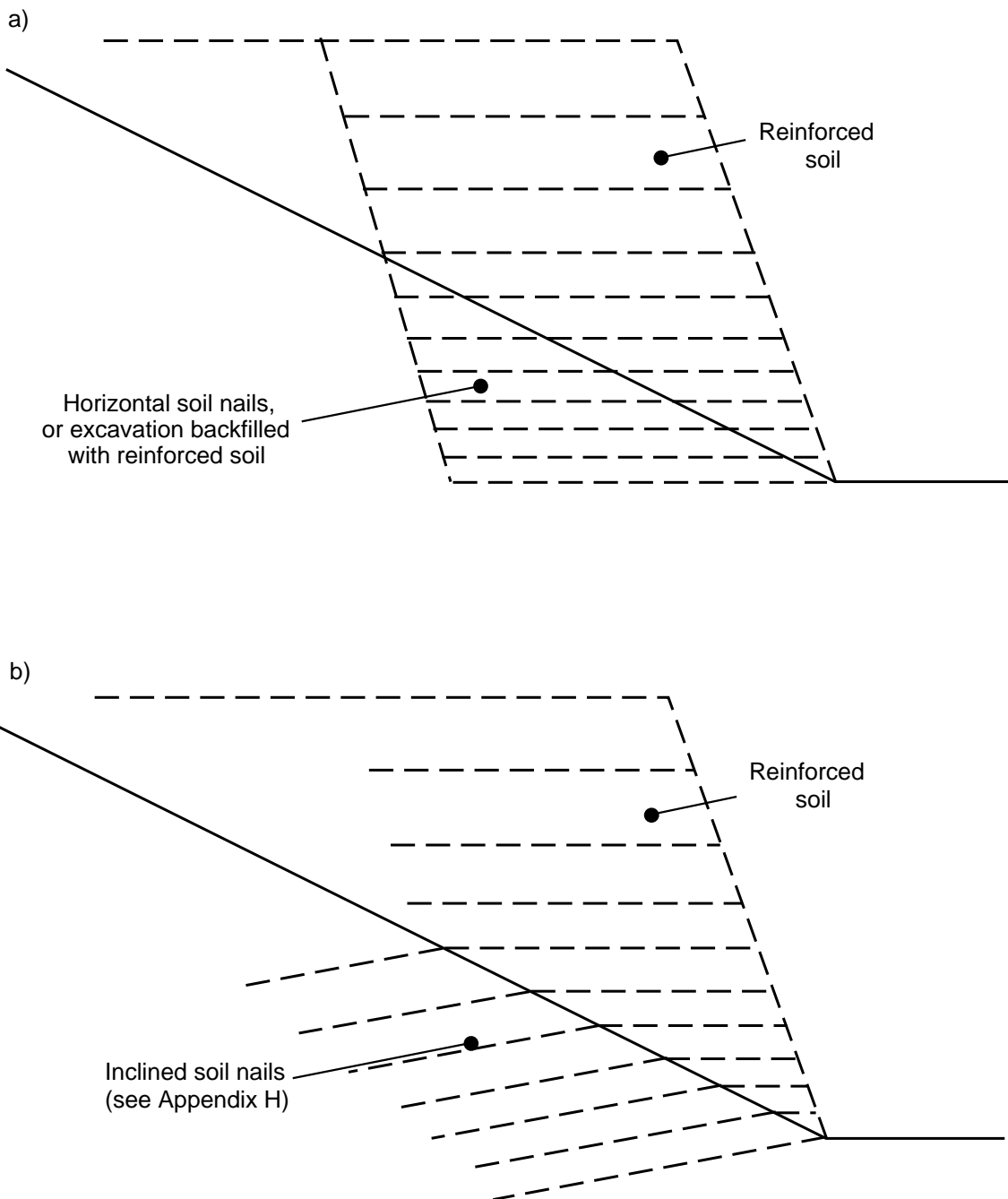

Figure 3.7 Hybrid construction

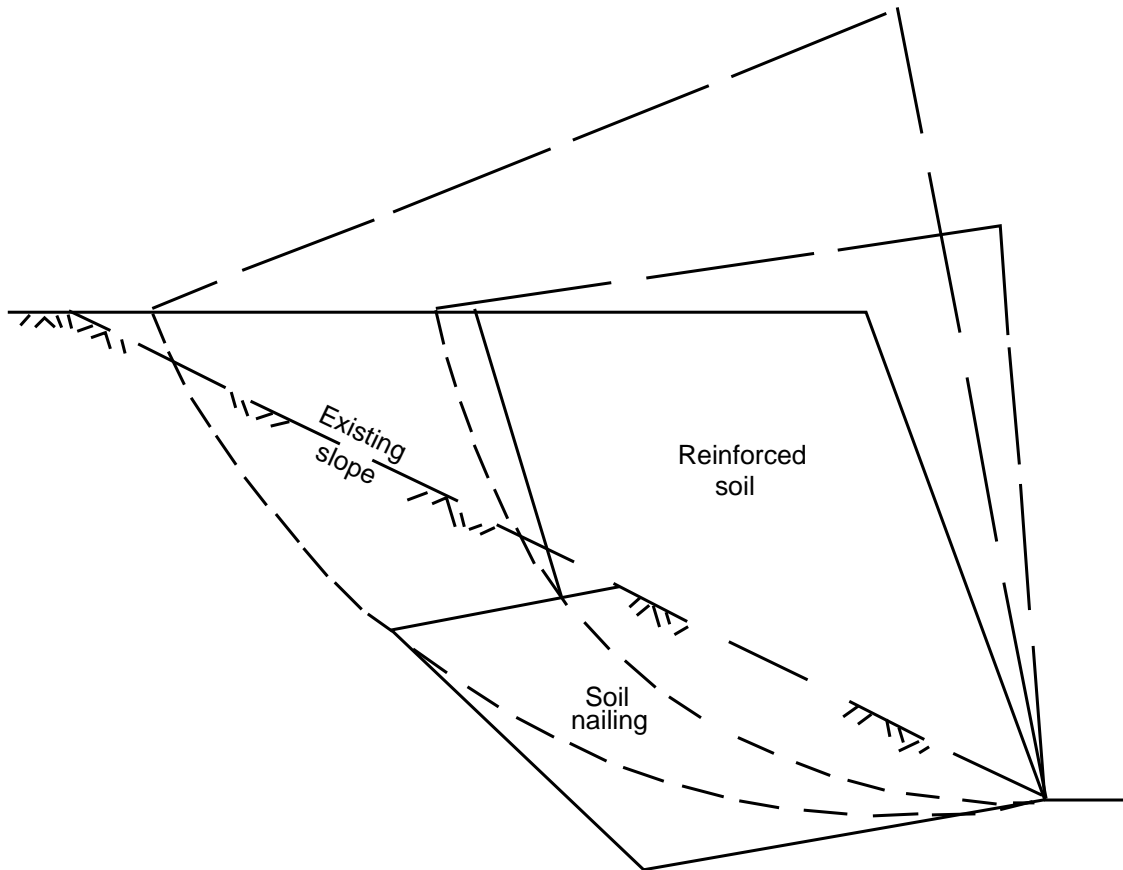

Figure 3.8 Short term stability of hybrid: Potential failure mechanisms

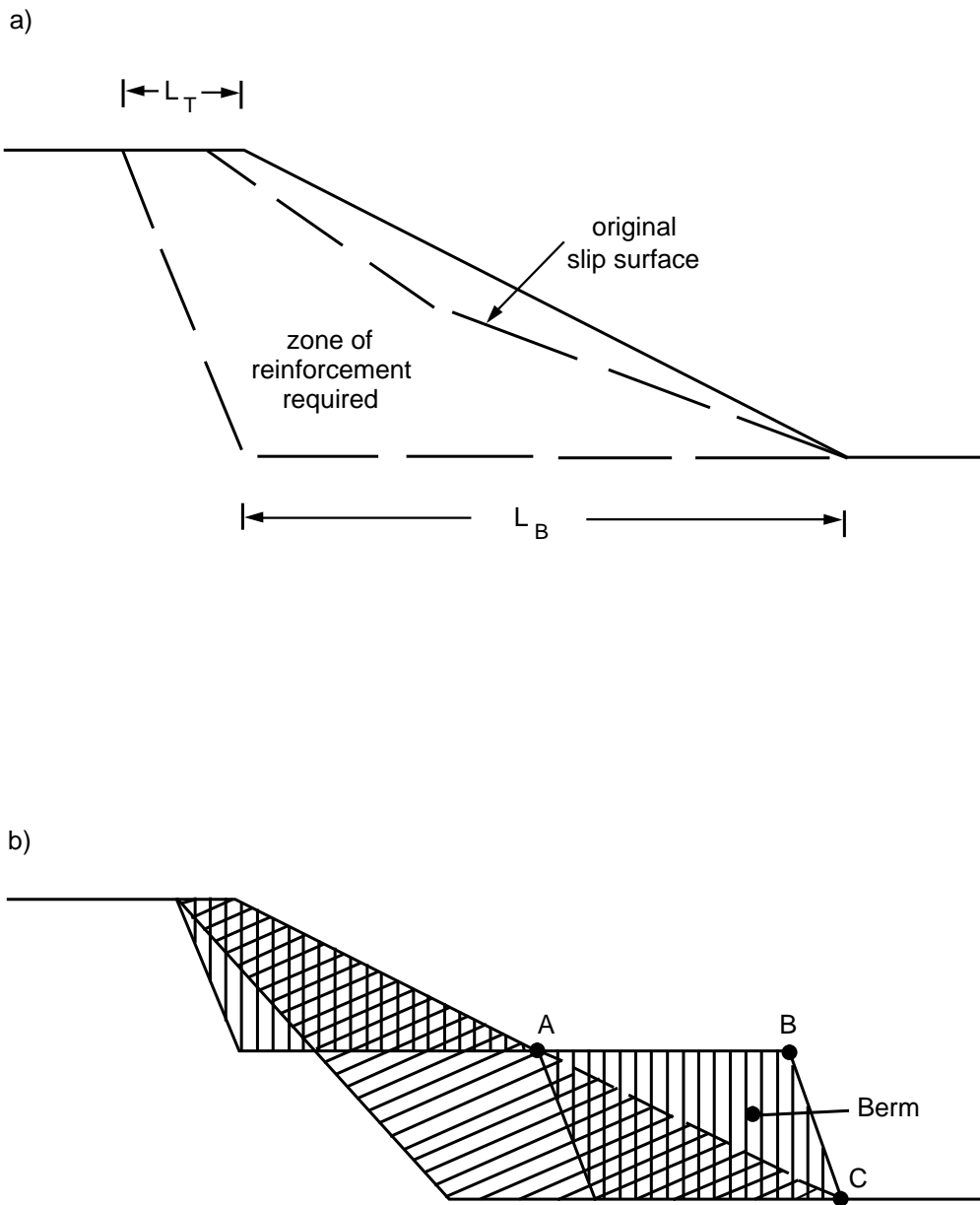

Figure 3.9 Repair of slip failures



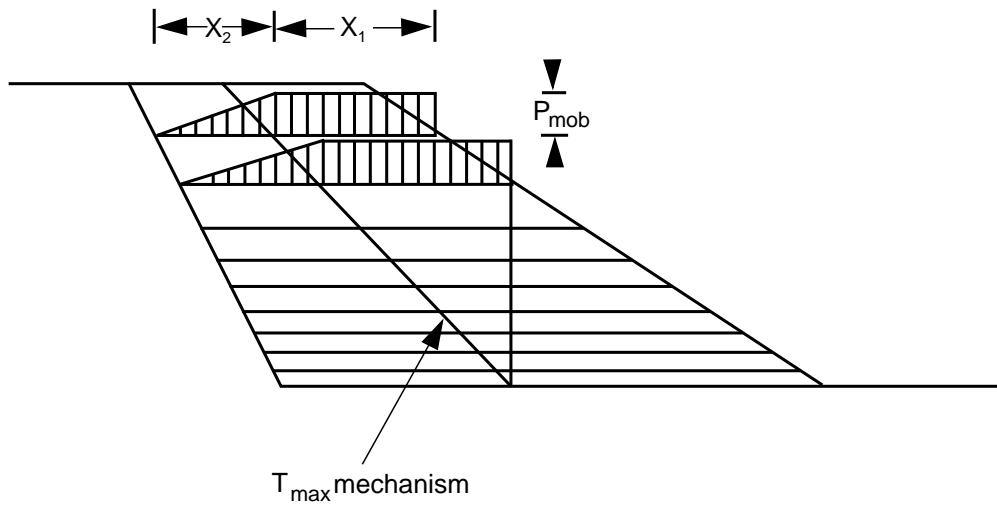

Figure 3.10 Assumed profile of tension along reinforced layer

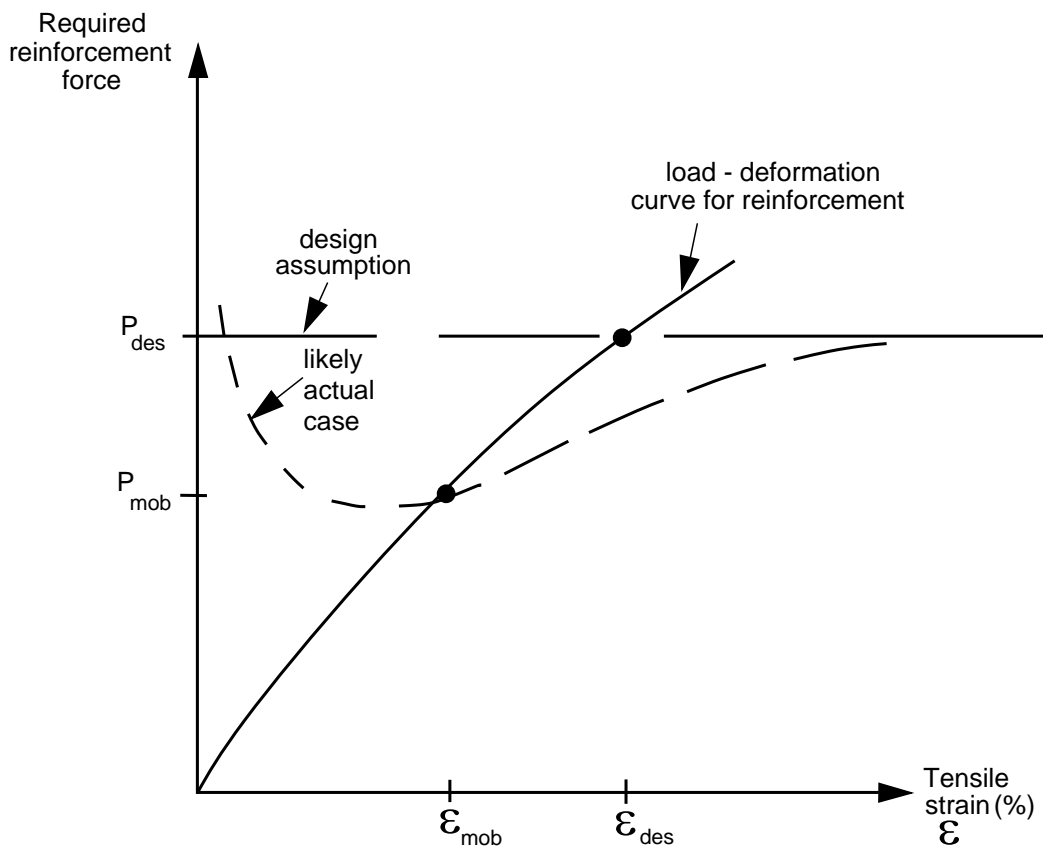

Figure 3.11 Load - strain compatibility curve

Table 3.1 (a) Two-part wedge solutions for horizontal reinforcement  
 $(r_u = 0, \lambda_s = 0.8, \theta_2 \geq 0)$

| $\beta$ | $\phi'$ | K     | X/H  | Y/H  | $\theta_1$ | $L_p/H$ |
|---------|---------|-------|------|------|------------|---------|
| 20      | 15      | 0.152 | 1.87 | 0.00 | 39         | 2.75    |
| 25      | 15      | 0.243 | 1.53 | 0.00 | 43         | 2.45    |
|         | 20      | 0.087 | 1.17 | 0.00 | 39         | 1.85    |
| 30      | 15      | 0.307 | 1.27 | 0.00 | 46         | 2.24    |
|         | 20      | 0.156 | 1.04 | 0.00 | 44         | 1.71    |
| 35      | 15      | 0.355 | 1.06 | 0.00 | 47         | 2.09    |
|         | 20      | 0.211 | 0.90 | 0.00 | 46         | 1.56    |
|         | 25      | 0.101 | 0.70 | 0.00 | 45         | 1.22    |
| 40      | 15      | 0.393 | 0.90 | 0.00 | 48         | 1.97    |
|         | 20      | 0.255 | 0.77 | 0.00 | 48         | 1.44    |
|         | 25      | 0.146 | 0.63 | 0.00 | 47         | 1.14    |
|         | 30      | 0.066 | 0.46 | 0.00 | 46         | 0.86    |
| 45      | 15      | 0.424 | 0.76 | 0.00 | 49         | 1.87    |
|         | 20      | 0.291 | 0.66 | 0.00 | 49         | 1.34    |
|         | 25      | 0.184 | 0.55 | 0.00 | 49         | 1.04    |
|         | 30      | 0.102 | 0.43 | 0.00 | 49         | 0.83    |
| 50      | 15      | 0.450 | 0.64 | 0.00 | 50         | 1.79    |
|         | 20      | 0.322 | 0.56 | 0.00 | 50         | 1.26    |
|         | 25      | 0.217 | 0.48 | 0.00 | 51         | 0.96    |
|         | 30      | 0.135 | 0.38 | 0.00 | 51         | 0.78    |
|         | 35      | 0.073 | 0.29 | 0.00 | 51         | 0.60    |
| 55      | 15      | 0.473 | 0.54 | 0.00 | 50         | 1.72    |
|         | 20      | 0.349 | 0.47 | 0.00 | 51         | 1.19    |
|         | 25      | 0.247 | 0.41 | 0.00 | 52         | 0.89    |
|         | 30      | 0.165 | 0.35 | 0.00 | 53         | 0.71    |
|         | 35      | 0.101 | 0.26 | 0.00 | 54         | 0.57    |
|         | 40      | 0.054 | 0.19 | 0.00 | 54         | 0.42    |
| 60      | 15      | 0.493 | 0.44 | 0.00 | 51         | 1.66    |
|         | 20      | 0.373 | 0.39 | 0.00 | 52         | 1.13    |
|         | 25      | 0.274 | 0.34 | 0.00 | 53         | 0.83    |
|         | 30      | 0.193 | 0.29 | 0.00 | 54         | 0.65    |
|         | 35      | 0.127 | 0.23 | 0.00 | 55         | 0.53    |
|         | 40      | 0.077 | 0.17 | 0.00 | 56         | 0.41    |
| 65      | 15      | 0.511 | 0.36 | 0.00 | 51         | 1.61    |
|         | 20      | 0.396 | 0.32 | 0.00 | 53         | 1.08    |
|         | 25      | 0.299 | 0.28 | 0.00 | 54         | 0.78    |
|         | 30      | 0.218 | 0.24 | 0.00 | 56         | 0.59    |
|         | 35      | 0.153 | 0.20 | 0.00 | 57         | 0.48    |
|         | 40      | 0.101 | 0.15 | 0.00 | 58         | 0.38    |
| 70      | 15      | 0.528 | 0.28 | 0.00 | 51         | 1.56    |
|         | 20      | 0.416 | 0.25 | 0.00 | 53         | 1.02    |
|         | 25      | 0.322 | 0.22 | 0.00 | 55         | 0.73    |
|         | 30      | 0.243 | 0.19 | 0.00 | 57         | 0.54    |
|         | 35      | 0.177 | 0.16 | 0.00 | 58         | 0.42    |
|         | 40      | 0.124 | 0.13 | 0.00 | 60         | 0.34    |

**Table 3.1 (b) Two-part wedge solutions for horizontal reinforcement**  
 $(r_u = 0.25, \lambda_s = 0.8, \theta_2 \geq 0)$

| $\beta$ | $\phi'$ | K     | X/H  | Y/H  | $\theta_1$ | $L_R/H$ |
|---------|---------|-------|------|------|------------|---------|
| 20      | 15      | 0.326 | 2.21 | 0.00 | 44         | 3.53    |
|         | 20      | 0.162 | 1.91 | 0.00 | 41         | 2.79    |
| 25      | 15      | 0.404 | 1.75 | 0.00 | 46         | 3.23    |
|         | 20      | 0.256 | 1.57 | 0.00 | 45         | 2.49    |
|         | 25      | 0.133 | 1.33 | 0.00 | 42         | 2.06    |
| 30      | 15      | 0.459 | 1.43 | 0.00 | 48         | 3.02    |
|         | 20      | 0.323 | 1.30 | 0.00 | 47         | 2.28    |
|         | 25      | 0.208 | 1.15 | 0.00 | 46         | 1.86    |
|         | 30      | 0.112 | 0.95 | 0.00 | 44         | 1.56    |
| 35      | 15      | 0.499 | 1.18 | 0.00 | 49         | 2.85    |
|         | 20      | 0.373 | 1.09 | 0.00 | 49         | 2.13    |
|         | 25      | 0.265 | 0.98 | 0.00 | 49         | 1.71    |
|         | 30      | 0.172 | 0.85 | 0.00 | 47         | 1.44    |
|         | 35      | 0.096 | 0.69 | 0.00 | 46         | 1.20    |
| 40      | 15      | 0.530 | 0.99 | 0.00 | 49         | 2.75    |
|         | 20      | 0.413 | 0.92 | 0.00 | 50         | 2.01    |
|         | 25      | 0.311 | 0.84 | 0.00 | 50         | 1.59    |
|         | 30      | 0.222 | 0.74 | 0.00 | 50         | 1.32    |
|         | 35      | 0.147 | 0.63 | 0.00 | 49         | 1.13    |
|         | 40      | 0.086 | 0.51 | 0.00 | 48         | 0.94    |
| 45      | 15      | 0.556 | 0.84 | 0.00 | 50         | 2.65    |
|         | 20      | 0.445 | 0.77 | 0.00 | 51         | 1.92    |
|         | 25      | 0.348 | 0.71 | 0.00 | 52         | 1.49    |
|         | 30      | 0.264 | 0.64 | 0.00 | 52         | 1.22    |
|         | 35      | 0.191 | 0.56 | 0.00 | 52         | 1.04    |
|         | 40      | 0.129 | 0.48 | 0.00 | 51         | 0.90    |
| 50      | 15      | 0.578 | 0.70 | 0.00 | 50         | 2.57    |
|         | 20      | 0.473 | 0.66 | 0.00 | 52         | 1.83    |
|         | 25      | 0.381 | 0.61 | 0.00 | 53         | 1.41    |
|         | 30      | 0.300 | 0.55 | 0.00 | 53         | 1.14    |
|         | 35      | 0.230 | 0.49 | 0.00 | 54         | 0.96    |
|         | 40      | 0.169 | 0.43 | 0.00 | 54         | 0.83    |
| 55      | 15      | 0.597 | 0.59 | 0.00 | 51         | 2.50    |
|         | 20      | 0.496 | 0.55 | 0.00 | 52         | 1.76    |
|         | 25      | 0.409 | 0.51 | 0.00 | 54         | 1.34    |
|         | 30      | 0.332 | 0.47 | 0.00 | 55         | 1.07    |
|         | 35      | 0.265 | 0.42 | 0.00 | 55         | 0.89    |
|         | 40      | 0.205 | 0.37 | 0.00 | 56         | 0.76    |
| 60      | 15      | 0.613 | 0.49 | 0.00 | 51         | 2.44    |
|         | 20      | 0.517 | 0.45 | 0.00 | 53         | 1.70    |
|         | 25      | 0.434 | 0.42 | 0.00 | 54         | 1.28    |
|         | 30      | 0.361 | 0.39 | 0.00 | 56         | 1.01    |
|         | 35      | 0.296 | 0.36 | 0.00 | 57         | 0.83    |
|         | 40      | 0.239 | 0.32 | 0.00 | 58         | 0.70    |
| 65      | 15      | 0.628 | 0.39 | 0.00 | 51         | 2.38    |
|         | 20      | 0.537 | 0.37 | 0.00 | 53         | 1.65    |
|         | 25      | 0.457 | 0.34 | 0.00 | 55         | 1.22    |
|         | 30      | 0.387 | 0.32 | 0.00 | 57         | 0.96    |
|         | 35      | 0.325 | 0.29 | 0.00 | 58         | 0.77    |
|         | 40      | 0.271 | 0.27 | 0.00 | 59         | 0.64    |
| 70      | 15      | 0.642 | 0.31 | 0.00 | 52         | 2.33    |
|         | 20      | 0.554 | 0.29 | 0.00 | 54         | 1.60    |
|         | 25      | 0.478 | 0.27 | 0.00 | 56         | 1.17    |
|         | 30      | 0.411 | 0.25 | 0.00 | 57         | 0.90    |
|         | 35      | 0.353 | 0.23 | 0.00 | 59         | 0.72    |
|         | 40      | 0.301 | 0.21 | 0.00 | 60         | 0.59    |

**Table 3.1 (c) Two-part wedge solutions for horizontal reinforcement**  
 $(r_u = 0.5, \lambda_s = 0.8, \theta_2 \geq 0)$

| $\beta$ | $\phi'$ | K     | X/H  | Y/H  | $\theta_1$ | $L_R/H$ |
|---------|---------|-------|------|------|------------|---------|
| 20      | 15      | 0.530 | 2.44 | 0.00 | 47         | 5.08    |
|         | 20      | 0.400 | 2.32 | 0.00 | 47         | 3.93    |
|         | 25      | 0.280 | 2.16 | 0.00 | 45         | 3.26    |
|         | 30      | 0.170 | 1.95 | 0.00 | 42         | 2.82    |
|         | 35      | 0.073 | 1.64 | 0.00 | 38         | 2.41    |
| 25      | 15      | 0.587 | 1.92 | 0.00 | 49         | 4.78    |
|         | 20      | 0.474 | 1.83 | 0.00 | 49         | 3.63    |
|         | 25      | 0.369 | 1.73 | 0.00 | 49         | 2.96    |
|         | 30      | 0.272 | 1.60 | 0.00 | 47         | 2.53    |
|         | 35      | 0.181 | 1.45 | 0.00 | 45         | 2.21    |
| 40      | 0.100   | 1.23  | 0.00 | 41   | 1.93       |         |
| 30      | 15      | 0.627 | 1.55 | 0.00 | 49         | 4.57    |
|         | 20      | 0.526 | 1.49 | 0.00 | 50         | 3.43    |
|         | 25      | 0.432 | 1.42 | 0.00 | 51         | 2.75    |
|         | 30      | 0.344 | 1.34 | 0.00 | 50         | 2.31    |
|         | 35      | 0.262 | 1.24 | 0.00 | 49         | 2.00    |
| 40      | 0.185   | 1.11  | 0.00 | 47   | 1.77       |         |
| 35      | 15      | 0.656 | 1.28 | 0.00 | 50         | 4.42    |
|         | 20      | 0.564 | 1.23 | 0.00 | 51         | 3.27    |
|         | 25      | 0.479 | 1.18 | 0.00 | 52         | 2.60    |
|         | 30      | 0.399 | 1.12 | 0.00 | 52         | 2.16    |
|         | 35      | 0.324 | 1.05 | 0.00 | 52         | 1.85    |
| 40      | 0.253   | 0.97  | 0.00 | 51   | 1.62       |         |
| 40      | 15      | 0.679 | 1.07 | 0.00 | 51         | 4.30    |
|         | 20      | 0.594 | 1.03 | 0.00 | 52         | 3.16    |
|         | 25      | 0.515 | 0.99 | 0.00 | 53         | 2.48    |
|         | 30      | 0.442 | 0.95 | 0.00 | 54         | 2.04    |
|         | 35      | 0.373 | 0.90 | 0.00 | 54         | 1.73    |
| 40      | 0.307   | 0.84  | 0.00 | 54   | 1.50       |         |
| 45      | 15      | 0.698 | 0.90 | 0.00 | 51         | 4.21    |
|         | 20      | 0.618 | 0.86 | 0.00 | 52         | 3.06    |
|         | 25      | 0.545 | 0.84 | 0.00 | 54         | 2.39    |
|         | 30      | 0.478 | 0.80 | 0.00 | 55         | 1.94    |
|         | 35      | 0.414 | 0.77 | 0.00 | 55         | 1.63    |
| 40      | 0.353   | 0.72  | 0.00 | 56   | 1.41       |         |
| 50      | 15      | 0.713 | 0.76 | 0.00 | 51         | 4.13    |
|         | 20      | 0.638 | 0.73 | 0.00 | 53         | 2.98    |
|         | 25      | 0.570 | 0.70 | 0.00 | 54         | 2.30    |
|         | 30      | 0.507 | 0.68 | 0.00 | 56         | 1.86    |
|         | 35      | 0.449 | 0.65 | 0.00 | 57         | 1.55    |
| 40      | 0.393   | 0.62  | 0.00 | 57   | 1.33       |         |
| 55      | 15      | 0.726 | 0.63 | 0.00 | 51         | 4.06    |
|         | 20      | 0.656 | 0.61 | 0.00 | 53         | 2.91    |
|         | 25      | 0.592 | 0.59 | 0.00 | 55         | 2.23    |
|         | 30      | 0.533 | 0.57 | 0.00 | 57         | 1.79    |
|         | 35      | 0.479 | 0.55 | 0.00 | 58         | 1.49    |
| 40      | 0.427   | 0.52  | 0.00 | 59   | 1.26       |         |
| 60      | 15      | 0.738 | 0.52 | 0.00 | 52         | 4.00    |
|         | 20      | 0.671 | 0.50 | 0.00 | 53         | 2.85    |
|         | 25      | 0.611 | 0.49 | 0.00 | 55         | 2.17    |
|         | 30      | 0.557 | 0.48 | 0.00 | 57         | 1.73    |
|         | 35      | 0.506 | 0.45 | 0.00 | 59         | 1.42    |
| 40      | 0.458   | 0.44  | 0.00 | 60   | 1.20       |         |
| 65      | 15      | 0.749 | 0.42 | 0.00 | 52         | 3.94    |
|         | 20      | 0.686 | 0.41 | 0.00 | 54         | 2.79    |
|         | 25      | 0.629 | 0.40 | 0.00 | 57         | 2.12    |
|         | 30      | 0.578 | 0.38 | 0.00 | 58         | 1.68    |
|         | 35      | 0.530 | 0.37 | 0.00 | 59         | 1.37    |
| 40      | 0.487   | 0.36  | 0.00 | 61   | 1.14       |         |
| 70      | 15      | 0.759 | 0.33 | 0.00 | 52         | 3.90    |
|         | 20      | 0.699 | 0.00 | 0.00 | 54         | 2.74    |
|         | 25      | 0.645 | 0.00 | 0.00 | 56         | 2.07    |
|         | 30      | 0.597 | 0.00 | 0.00 | 58         | 1.63    |
|         | 35      | 0.553 | 0.00 | 0.00 | 60         | 1.32    |
| 40      | 0.513   | 0.00  | 0.00 | 62   | 1.09       |         |

**Table 3.2** Optimum vertical layer depths (for both horizontal and inclined reinforcement)

| Layer No | Normalised depth below crest, z/H |
|----------|-----------------------------------|
| 1        | 0.50 / $\sqrt{N}$                 |
| 2        | 1.00 / $\sqrt{N}$                 |
| 3        | 1.41 / $\sqrt{N}$                 |
| 4        | 1.73 / $\sqrt{N}$                 |
| 5        | 2.00 / $\sqrt{N}$                 |
| 6        | 2.24 / $\sqrt{N}$                 |
| 7        | 2.45 / $\sqrt{N}$                 |
| 8        | 2.65 / $\sqrt{N}$                 |
| 9        | 2.83 / $\sqrt{N}$                 |
| 10       | 3.00 / $\sqrt{N}$                 |
| .        | .                                 |
| i        | $\sqrt{(i - 1)}/\sqrt{N}$         |
| .        | .                                 |
| N        | $\sqrt{([N-1] / N)}$              |
| (N+1)    | 1.00                              |

**Note**

If surcharge,  $q$ , exists then substitute  $H'$  for  $H$  in the above, where:

$$H' = H + q/\gamma$$

(ie. depth to first layer of reinforcement would then be  $\frac{1}{2}H'/\sqrt{N} - q/\gamma$  below the actual top of the slope, Figure 3.4)

# 4. DESIGN PROCEDURE FOR REINFORCING HIGHWAY SLOPES WITH INCLINED REINFORCEMENT

## Introduction

4.1 The following chapter addresses the reinforcement of existing ground (natural or man-made) using inclined soil nails. Soil nails may be used to stabilise new cutting slopes, or in hybrid construction (see Chapter 3 and Appendix H). This chapter only deals with the former. The following two types of cutting are considered separately (Figures 4.1a and b respectively):

- Type 1 - cutting into horizontal ground
- Type 2 - cutting into toe of existing (stable or unstable) slope

The two-part wedge mechanism defined in Chapter 2 is used for the design of these types of slope stabilisation, with the general concepts given below.

## General Concepts

4.2 A method is sought by which both the total nail force (No. of rows of nails x No. of nails per metre width) and the overall dimensions of the nailed zone (  $L_T$  and  $L_B$ , Figure 4.2a) can be set. As before these are governed by separate factors, and it is convenient to use the same concepts as introduced in Chapter 3, with only slight amendments for the effect of an inclined nail force.

### The $T_{max\delta}$ Mechanism

4.3 The  $T_{max}$  mechanism, as defined earlier in paragraphs 3.3 to 3.6, is the critical two-part wedge mechanism which requires the greatest total horizontal reinforcement force. If the reinforcement is inclined at an angle,  $\delta$ , then the equivalent mechanism (which requires the greatest total reinforcement force inclined at an angle  $\delta$ ) is defined as the " $T_{max\delta}$  mechanism". Since the nail force is inclined at an angle  $\delta$ , however, the value of  $T_{max\delta}$  may not be solved from the general equation given in Appendix A without making some assumption regarding the distribution of nail forces in the slope. A simplifying assumption which will always be conservative (see Appendix A) is to assume that the

total nail force acts on Wedge 1, and that none acts on Wedge 2. In this case the ratio,  $\zeta$ , between  $T_{max\delta}$  and  $T_{max}$  for any given mechanism becomes simply:

$$T_{max\delta} = \frac{[\cos(\theta_1 - \phi'_1) / \cos(\theta_1 - \phi'_1 + \delta)] \cdot T_{max}}{\zeta \cdot T_{max}} \dots \dots \dots \text{Eqn 2}$$

where the value of  $T_{max}$  is defined by equation 1, paragraph 2.9. On performing a search for the critical  $T_{max\delta}$  mechanism, it will be found that the critical values of  $\theta_1$ , X and Y will be slightly different from those of the  $T_{max}$  mechanism, due to the additional function of  $\theta_1$  and  $\phi'_1$  above.

4.4 Since the function in Equation 2 above is greater than unity for all practical values of  $\theta_1$  it is advantageous, as discussed in Appendix I, to set the smallest practical value of  $\delta$  in order to minimise  $T_{max\delta}$ . Construction considerations are likely to control the minimum value of  $\delta$  (ie. placement of grout), and a reasonable value for  $\delta$  is  $10^\circ$ .

4.5 As before, the  $T_{max\delta}$  mechanism also governs the length of the reinforcement zone,  $L_T$ , at the top of the slope (Figure 4.2b). The length  $L_T$  is set such that the uppermost reinforcement layer of the  $T_{max\delta}$  mechanism has just sufficient length,  $L_{e1}$ , to mobilise its full pull-out resistance (see also the "Varying  $S_h$  Method" in paragraphs 4.20 to 4.22 below).

4.6 For the special case of a two-part wedge mechanism with  $\theta_2 = -\delta$ , where sliding of the lower wedge takes place along the plane of the soil nails, the effect of the base sliding factor,  $\lambda_s$ , should be taken into account (see paragraph 2.33).

4.7 For convenience, a listing of  $T_{max\delta}$  mechanisms (giving  $K_\delta$ , X/H, Y/H and  $\theta_1$ ) is provided in Table 4.1 for the case  $c'_{des} = 0$ ,  $\theta_2 \geq -\delta$ ,  $i = 0$  and  $\lambda_s = 1$ . The value of  $K_\delta$  is defined as  $K_\delta = T_{max\delta} / [0.5 \gamma H^2]$ .

*The  $T_{o\delta}$  Mechanism*

4.8 As in the case of horizontal reinforcement, the size of the reinforcement zone should be such that no two-part wedge mechanism requiring reinforcement force for stability can pass completely outside it. The concept of a " $T_o$  mechanism" has been described in paragraph 3.8. The  $T_{o\delta}$  mechanism is that which runs along the line of the lowest nail and slides upwards at the angle of inclination,  $\delta$  (ie.  $\theta_2 = -\delta$ , Figure 4.2c, but see also Appendix E). In most cases the critical value of  $\theta_1$  will be  $[\pi/4 + \phi'_{des}/2]$ , however where  $L_B$  is less than  $[H/\tan\beta]$ , or where  $\delta x_i \neq 0$ , then a search for the most critical value of  $\theta_1$  should be made.

4.9 The value of  $L_B$  for soil nailing (as defined in Figure 4.2c) is likely to be less than the equivalent value for horizontal reinforcement for two reasons. Firstly, Wedge 2 is constrained to move upwards (instead of sliding horizontally). Secondly, the value of  $\lambda_s$  for soil nailing is likely to be higher due to the relatively small plan area taken up by the nails when compared to continuous sheet reinforcement.

4.10 The above exercise is equivalent to setting the base dimension of the nailed soil block to act as a gravity retaining wall. It is assumed here that the ground underlying the toe of the slope is a competent bearing material. If this is not the case, other overall failure mechanisms should be checked, such as those shown on Figure 4.3 (see also Appendix B).

4.11 For convenience, a listing of values for  $L_B$  is given in Table 4.1 for the case of  $c'_{des} = 0$ ,  $i = 0$  and  $\lambda_s = 1$ .

*Optimum Vertical Spacing*

4.12 The optimum vertical spacing for inclined reinforcement is independent of the angle of inclination,  $\delta$ . Provided that the value of  $T_{max\delta}$  is as defined above, the identical values of  $z_i$  given in Table 3.2 for horizontal reinforcement may also be used for soil nailing (assuming all layers have identical capacity,  $T_{max\delta}/N$ ).

4.13 It may be advantageous to insert the first layer of nails at a steeper angle than the others in order to increase pull-out resistance.

4.14 Alternative vertical spacing layouts may also be adopted however (eg constant vertical spacing

with depth) if appropriate adjustments are made to the horizontal spacing,  $S_h$  (see Appendices F and I). In this case the layers of reinforcement would not have identical capacities, but would have to increase in capacity successively with depth.

4.15 In any case, it is recommended that the maximum value of  $S_v$  be limited to 2m, and that  $S_h$  should not exceed the maximum value of  $S_v$ .

**Design of Cuttings into Horizontal Ground***Type 1 Cutting*

4.16 A preliminary estimate of the total quantity of soil nail reinforcement and layout required to support a cutting slope (slope  $\beta$ , soil parameters  $\phi'_{des}$ ,  $c'_{des}$ ,  $\gamma$ , and pore water pressure parameter  $r_u$ ) of the type shown in Figure 4.1a with a horizontal crest should be arrived at by the following basic procedure. (It is assumed for the basic procedure that the horizontal nail spacing,  $S_h$  remains constant throughout the slope).

*Basic Procedure*

4.17 The steps in the basic procedure are as follows:

- i. Perform computer searches (based on equation 2, paragraph 4.3) for the  $T_{max\delta}$  and  $T_{o\delta}$  mechanisms.
- ii. Choose  $P_{des}$  (paragraph 2.22) and calculate  $N$  (where  $N = T_{max\delta} / P_{des}$ ) rounded up to the next integer. Calculate the depth,  $z_1$  to the first nail (Table 3.2). Calculate the pull-out length,  $L_{e1}$  required on the first nail (paragraph 2.23). (N.B. value of  $\sigma'_n$  is dependent on  $L_{e1}$ , hence iteration will be required).
- iii. Draw the  $T_{max\delta}$  and  $T_{o\delta}$  mechanisms on the slope section. Mark on  $L_{e1}$  and read off  $L_T$  and  $L_B$ , as shown on Figure 4.2 (if  $L_{e1}$  is excessive, opt for the *Varying  $S_h$  Method*, below). Draw on all other nails based on spacings given in Table 3.2.

Worked example No 3 demonstrates the above procedure for determining a preliminary estimate of the reinforcement required. The preliminary estimate of required nail force and layout obtained should then be checked.

*Checks*

4.18 The following checks should be carried out as appropriate:

- i. Check construction condition, missing out the lowest nail, but using short term soil strength parameters, (or using effective stress parameters with the value of  $r_u$  relevant during construction).
- ii. Check intermediate mechanisms between  $T_{\max\delta}$  and  $T_{o\delta}$  mechanisms (see Appendix G).
- iii. Check that  $L_B$  allows sufficient pull-out length on the bottom row of nails behind the  $T_{\max\delta}$  mechanism, and if not, extend  $L_B$  accordingly. (This is only likely to be critical for small values of  $d_{\text{hole}}$  or large values of  $S_h$ ).
- iv. The assumption of a competent bearing material beneath the embankment slope should be reviewed and, if necessary, underlying slip mechanisms checked (see Figure 4.3, and also Appendix B). It should be noted that the mechanisms provided in Table 4.1 are for  $\theta_2 \geq -\delta$  only.
- v. For grouted nails the bond stress between the grouted annulus and the bar should be checked for adequacy.
- vi. If no structural facing is provided then the capacity of waling plates should be checked (Appendix E). It is also likely that increased values of  $L_T$  and  $L_B$  will be required in this instance (see Appendix G).
- vii. Consider the possible effects of expansion of the soil due to swelling or freezing.
- viii. Check that drainage measures are compatible with the pore water pressures assumed. Consider also the potential effects of water filled tension cracks.
- ix. Check the adequacy of any front face protection provided, such as shotcrete or netting.

4.19 For conditions where the short term soil strength is not significantly better than the long term, then the construction case will always govern. The simplest adjustment to make in this case would be to increase  $N$  by one, thus providing for the nail layer which is always missing at the base of the current excavation step.

*Revised Approach if  $L_{e1}$  Excessive ("Varying  $S_h$  Method")*

4.20 In some instances pull-out lengths on the top row of nails, and hence  $L_T$ , can be excessive, even if  $d_{\text{hole}}$  is set to a maximum. In such cases the required value of  $L_{e1}$  may be shortened to  $L'_{e1}$  by decreasing the horizontal spacing between nails by the same factor. Provided that  $S_{h1} / L_{e1} = S'_{h1} / L'_{e1}$ , then the force per metre run of slope available from the first layer of nails will remain approximately unchanged.

4.21 If  $L_{e1}$  is factored in this fashion it will also be advantageous to decrease  $d_{\text{bar}}$  by the square root of the factor (for the first layer of soil nails only) in order to avoid unnecessary over-design.

4.22 It should be noted that to carry this to its extreme, very low values of  $L_{e1}$  (and hence  $L_T$ ) could be achieved if very low values of  $S_{h1}$  are adopted. However, this would be likely to result in insufficient pull-out lengths for lower layers of nails, unless their horizontal spacings were also adjusted. It is therefore necessary to set a practical limit for the extent of  $L_{e1}$  reduction, and this is represented by the length  $L'_{e1}$  in Figure 4.4, such that no shortening of  $L_{e2}$  is allowed.

**Cuttings into the Toe of Existing Slopes***Type 2 Cutting*

4.23 It is becoming increasingly common in roadway widening programmes to form cuttings at the toe of existing natural or man-made slopes (Figure 4.1 b). This represents a special case of slope reinforcement since the stability of the existing slope above the new cutting must also be taken into account.

4.24 For the case of an inclined upper slope of limited extent,  $H_{\max}$  (Figure 4.5) the algebraic definitions given in Table 2.1 should be amended as shown in Table 4.2. (The terms in Table 4.2 refer to Figure 4.7). If a box is left blank in Table 4.2, then the value given in Table 2.1 still applies.

- 4.25 There are two categories of existing slope:
- Stable
  - Unstable



*Stable Existing Slopes*

4.26 A stable existing slope is one which is found to need no reinforcement (*before* the new cut is made), when analysed by the two-part wedge mechanism using soil parameters  $\phi'_{des}$ ,  $c'_{des}$  and the design value of  $r_u$ . In the simplest case of  $c'_{des} = r_u = 0$ , any slope with an angle  $i$  less than or equal to  $\phi'_{des}$  would be defined as stable.

4.27 For the case of a stable existing slope (where nails are only required on the new steepened slope face) the design should follow the same basic procedure and checks already given in paragraphs 4.16 to 4.22, assuming an infinite upper slope,  $i$ . If  $H_{max}$  is likely to influence the failure mechanism (as in Figure 4.5), then the algebraic formulae should be adjusted as described in Table 4.2. But it should be noted that in this case the "mini"  $T_{max}$  mechanism (Figure F.1) will *not* be geometrically similar to the reduced scale  $T_{max}$  mechanism (as normally implicitly assumed in the design philosophy, Appendix F). It will normally be sufficient in such cases to simply add one extra layer of reinforcement at the level of the lower slope crest (Figure 4.8), but special checking for the "mini"  $T_{max}$  mechanisms should therefore be carried out here.

*Unstable Existing Slopes*

4.28 An unstable existing slope is one which is found to need reinforcement (*before* the new cut is made), when analysed by the two-part wedge mechanism using soil parameters  $\phi'_{des}$ ,  $c'_{des}$  and the design value of  $r_u$  i.e. the slope might be standing at the moment but cannot be relied to remain standing in the long term. In the simplest case of  $c'_{des} = r_u = 0$ , any slope with an angle  $i$  greater than  $\phi'_{des}$  would be defined as unstable.

4.29 For the case of an unstable existing slope (where nails are required on both the upper existing slope and the new steepened slope face, Figure 4.6) the design for the lower slope should follow the basic procedure given above for stable existing slopes. The reinforcement required in the upper slope alone should then be assessed, treating it as a separate slope with a height of  $(H_{max} - H)$  as shown in Figure 4.6, using the basic procedure in paragraphs 4.16 to 4.22.

4.30 Worked example No 6 demonstrates the above steps for determining a preliminary estimate of the reinforcement required. The preliminary layout should then be subjected to the same additional checks as given in paragraphs 4.16 to 4.22.

a) Type 1

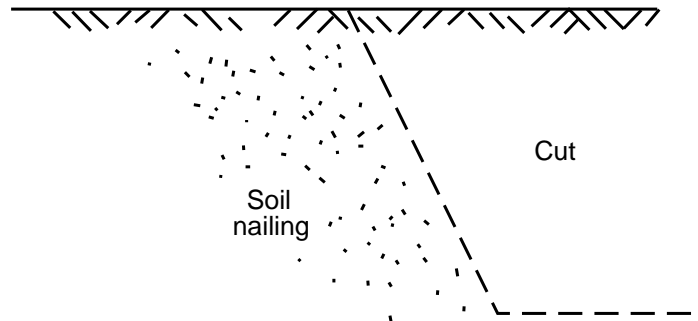

b) Type 2

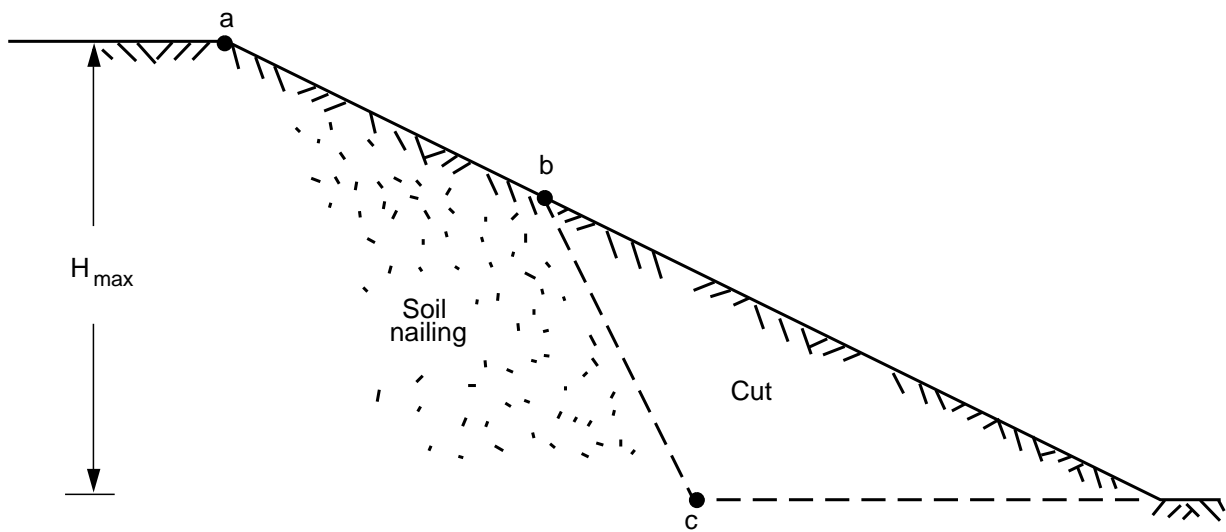

Figure 4.1 Types of cutting

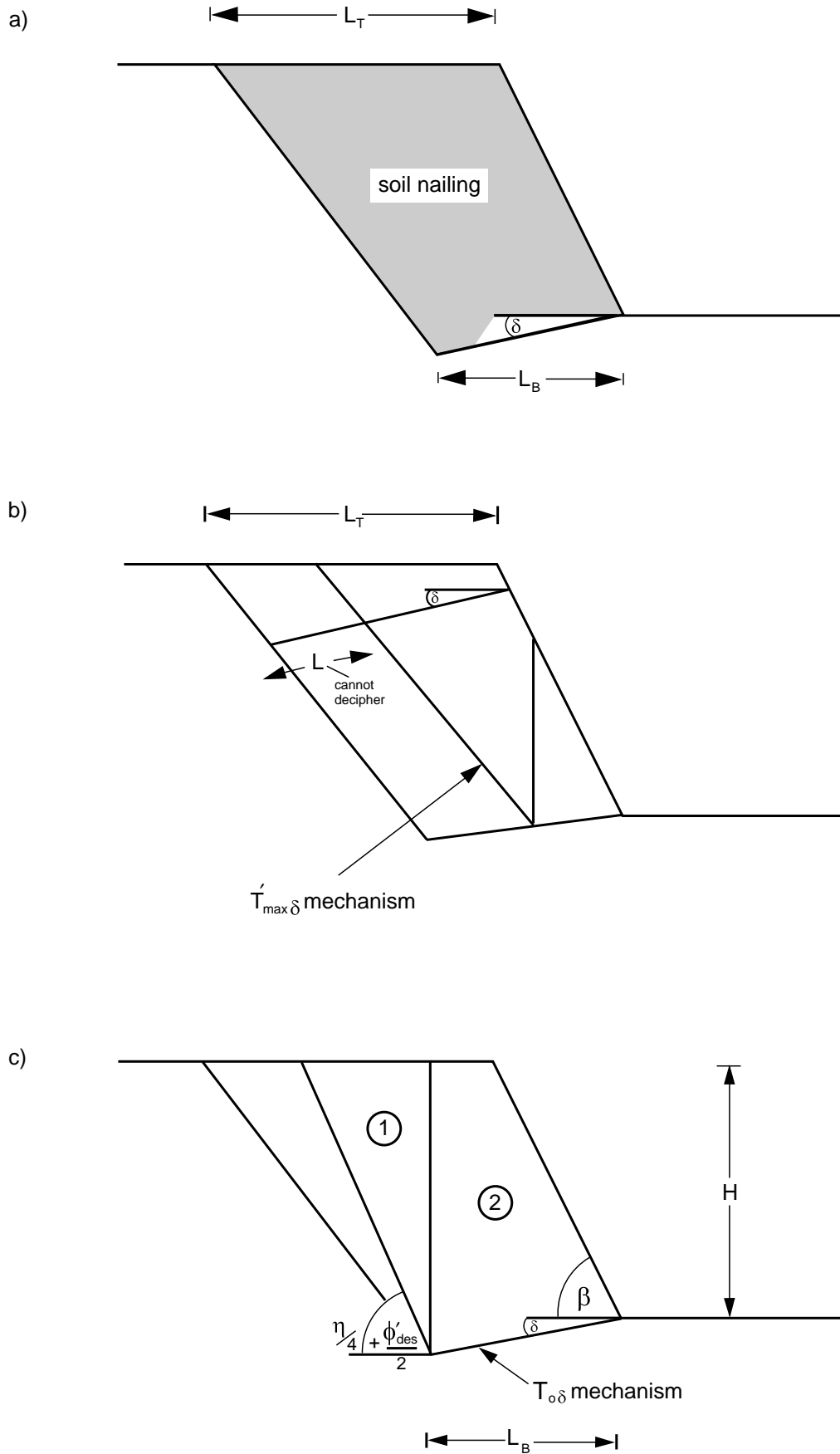

Figure 4.2 General concepts of design method for inclined reinforcement

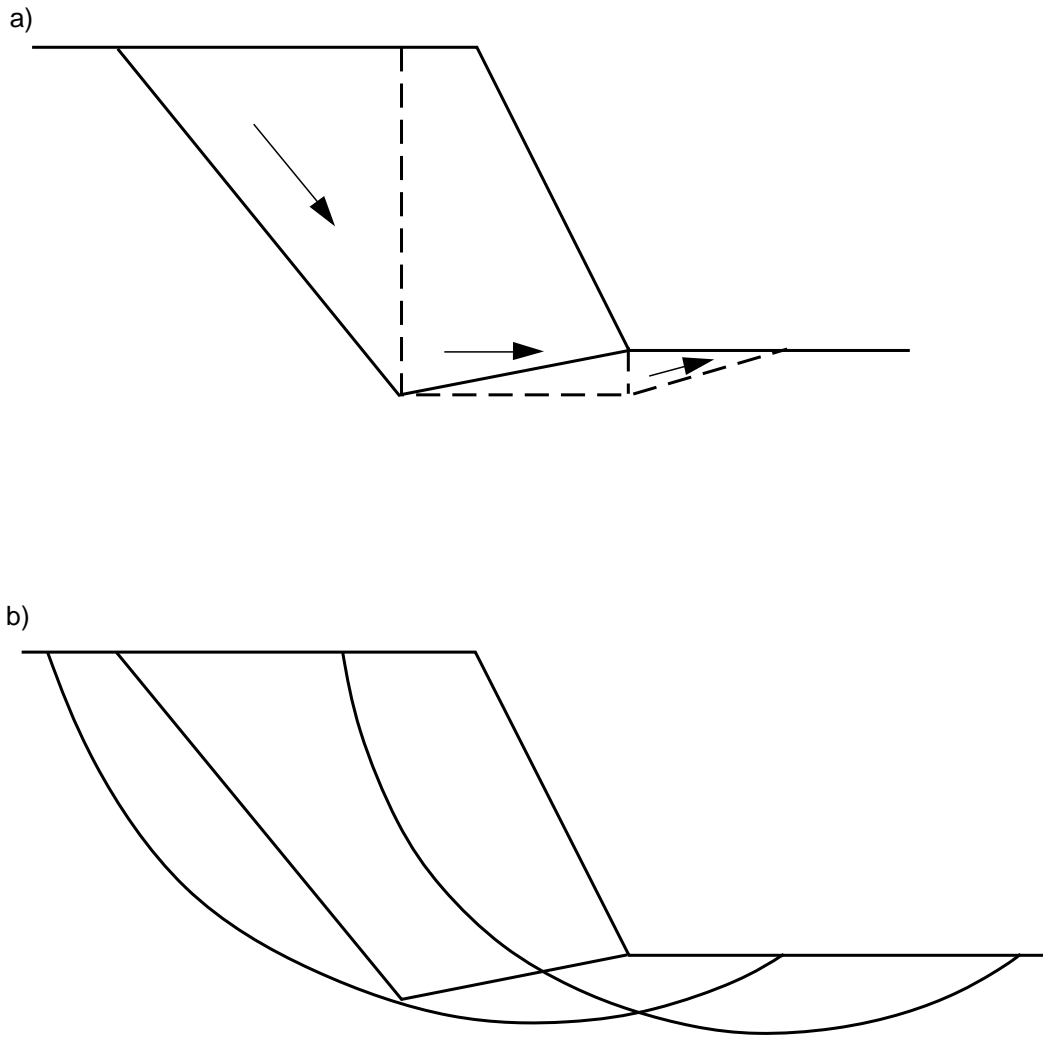

Figure 4.3 Underlying failure mechanisms

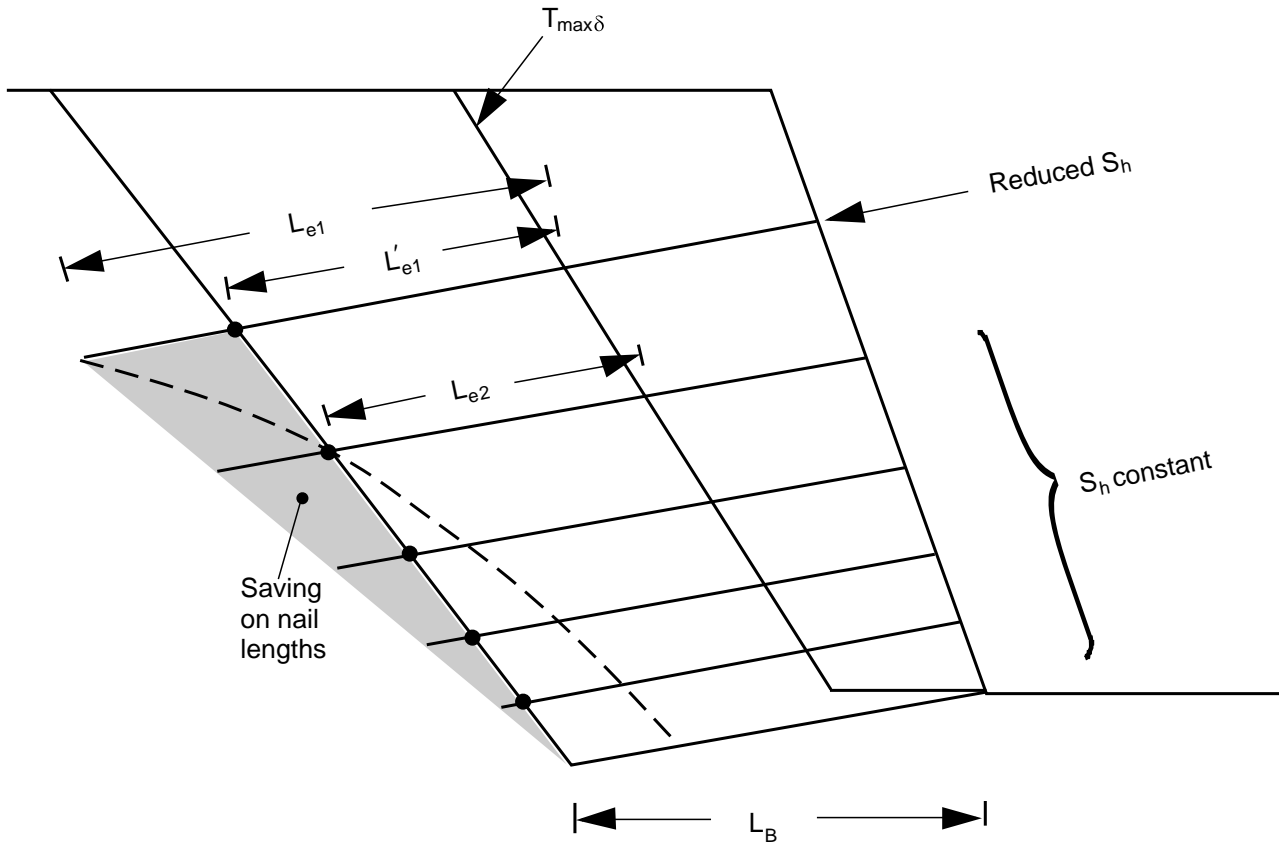

Figure 4.4 Reduction in  $L_{e1}$  by varying  $S_{h1}$  method

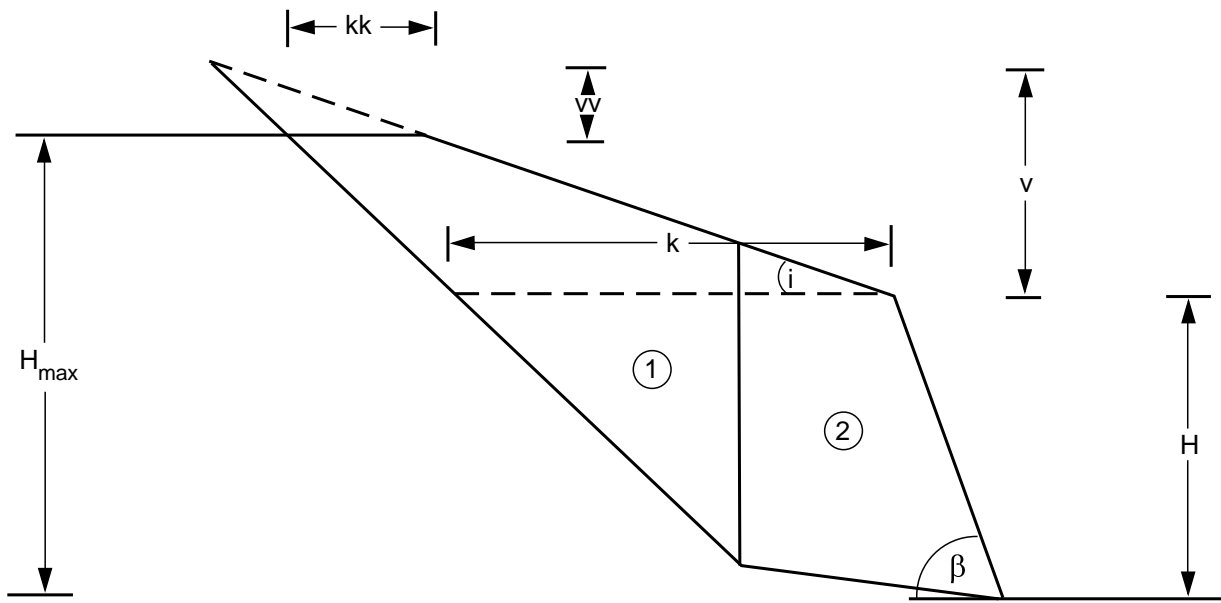
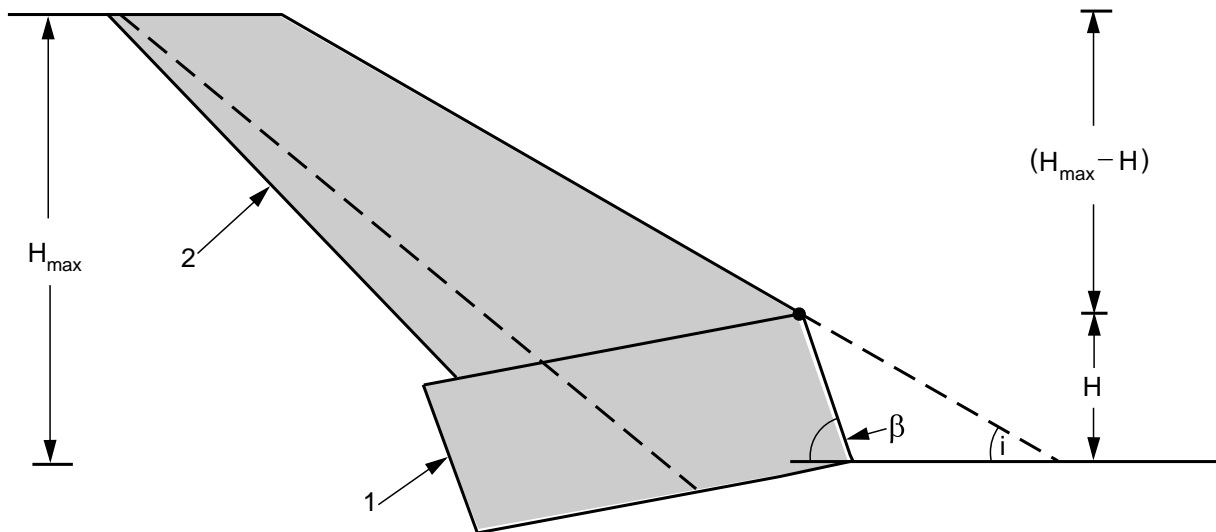

Figure 4.5 Limited upper slope



- 1 New slope requirement
- 2 Upper slope requirement

Figure 4.6 Cutting into toe of unstable existing slope

Case 1

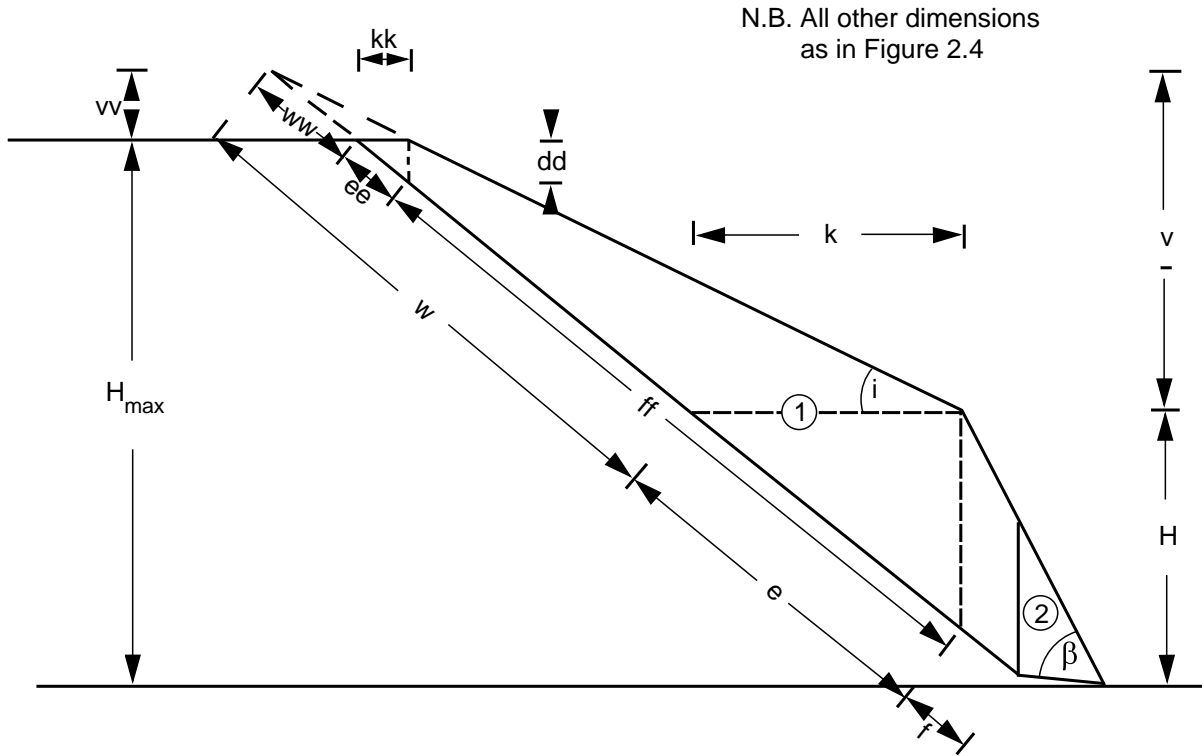

Case 2

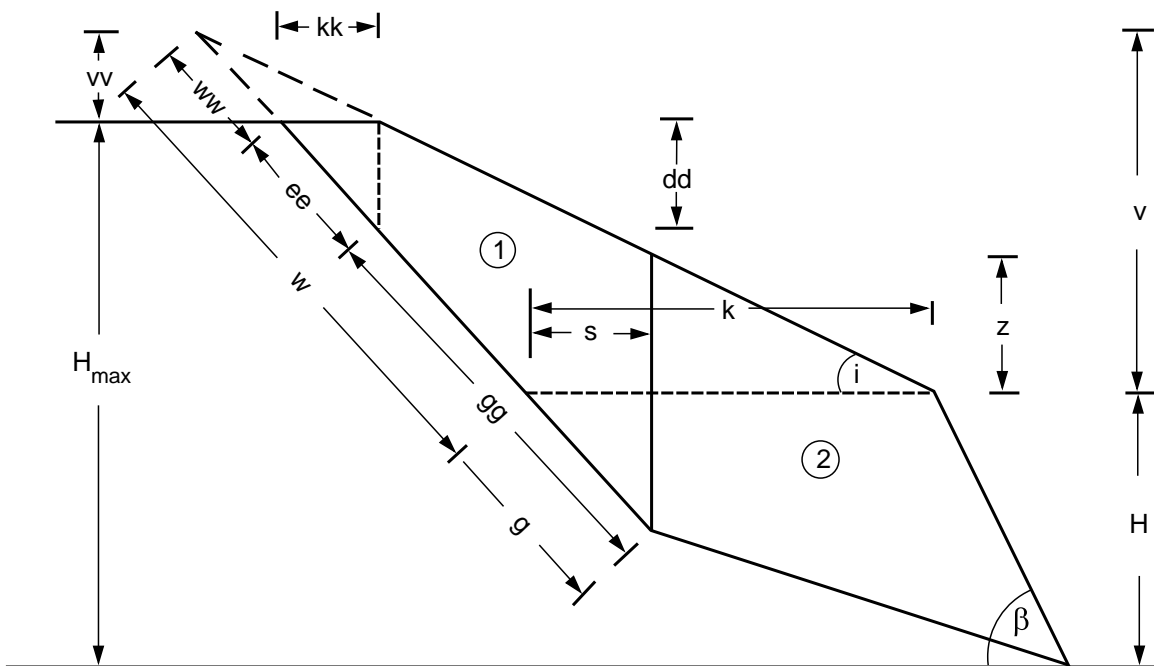

Figure 4.7 Definition of limited upper slope geometry (for Table 4.2)

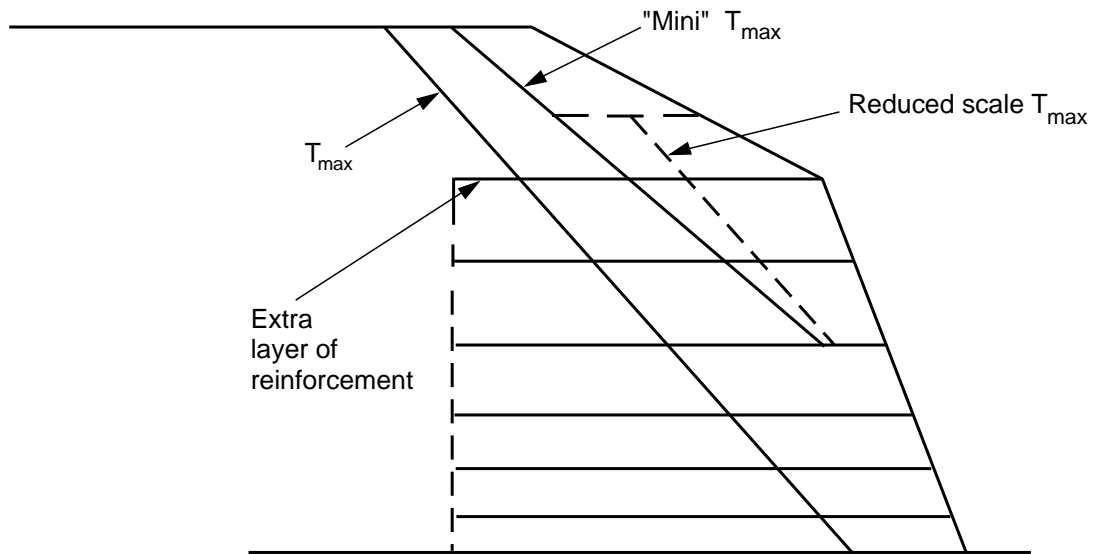

Figure 4.8



**Table 4.1 (a) Two-part wedge solutions for inclined reinforcement**  
 $(r_u = 0, \delta = 10^\circ, \lambda_s = 1, \theta_2 \geq -\delta)$

| $\beta$ | $\phi'$ | $K_\delta$ | X/H  | Y/H   | $\theta_1$ | $L_B/H$ |
|---------|---------|------------|------|-------|------------|---------|
| 20      | 15      | 0.104      | 1.46 | -0.03 | 33         | 1.80    |
| 25      | 15      | 0.216      | 1.16 | -0.14 | 38         | 1.82    |
|         | 20      | 0.058      | 1.14 | 0.14  | 36         | 1.04    |
| 30      | 15      | 0.306      | 0.97 | -0.17 | 42         | 1.68    |
|         | 20      | 0.129      | 0.93 | 0.04  | 41         | 1.18    |
|         | 25      | 0.036      | 0.90 | 0.22  | 39         | 0.61    |
| 35      | 15      | 0.377      | 0.86 | -0.15 | 46         | 1.53    |
|         | 20      | 0.193      | 0.78 | -0.01 | 44         | 1.16    |
|         | 25      | 0.085      | 0.76 | 0.13  | 44         | 0.78    |
|         | 30      | 0.024      | 0.70 | 0.24  | 42         | 0.38    |
| 40      | 15      | 0.432      | 0.75 | -0.13 | 48         | 1.41    |
|         | 20      | 0.249      | 0.65 | -0.04 | 47         | 1.08    |
|         | 25      | 0.133      | 0.64 | 0.09  | 47         | 0.80    |
|         | 30      | 0.060      | 0.62 | 0.19  | 47         | 0.51    |
|         | 35      | 0.018      | 0.62 | 0.31  | 47         | 0.24    |
| 45      | 15      | 0.478      | 0.66 | -0.12 | 51         | 1.31    |
|         | 20      | 0.297      | 0.55 | -0.06 | 49         | 1.00    |
|         | 25      | 0.177      | 0.54 | 0.05  | 50         | 0.77    |
|         | 30      | 0.097      | 0.54 | 0.15  | 50         | 0.55    |
|         | 35      | 0.045      | 0.52 | 0.23  | 51         | 0.34    |
|         | 40      | 0.013      | 0.52 | 0.33  | 51         | 0.15    |
| 50      | 15      | 0.516      | 0.57 | -0.10 | 52         | 1.22    |
|         | 20      | 0.340      | 0.47 | -0.07 | 51         | 0.92    |
|         | 25      | 0.217      | 0.46 | 0.03  | 51         | 0.73    |
|         | 30      | 0.133      | 0.45 | 0.11  | 53         | 0.55    |
|         | 35      | 0.074      | 0.45 | 0.19  | 54         | 0.38    |
|         | 40      | 0.035      | 0.44 | 0.26  | 55         | 0.23    |
| 55      | 15      | 0.549      | 0.49 | -0.09 | 54         | 1.15    |
|         | 20      | 0.378      | 0.40 | -0.07 | 52         | 0.85    |
|         | 25      | 0.254      | 0.39 | 0.02  | 53         | 0.67    |
|         | 30      | 0.167      | 0.38 | 0.09  | 55         | 0.53    |
|         | 35      | 0.104      | 0.38 | 0.15  | 56         | 0.39    |
|         | 40      | 0.059      | 0.37 | 0.21  | 58         | 0.27    |
| 60      | 15      | 0.579      | 0.41 | -0.07 | 56         | 1.08    |
|         | 20      | 0.412      | 0.34 | -0.06 | 53         | 0.79    |
|         | 25      | 0.289      | 0.32 | 0.01  | 55         | 0.61    |
|         | 30      | 0.199      | 0.32 | 0.07  | 56         | 0.50    |
|         | 35      | 0.133      | 0.31 | 0.12  | 58         | 0.38    |
|         | 40      | 0.084      | 0.31 | 0.17  | 60         | 0.28    |
| 65      | 15      | 0.605      | 0.34 | -0.06 | 57         | 1.02    |
|         | 20      | 0.443      | 0.28 | -0.05 | 55         | 0.73    |
|         | 25      | 0.321      | 0.26 | -0.00 | 56         | 0.56    |
|         | 30      | 0.230      | 0.26 | 0.05  | 58         | 0.45    |
|         | 35      | 0.161      | 0.25 | 0.09  | 59         | 0.36    |
|         | 40      | 0.109      | 0.25 | 0.14  | 61         | 0.27    |
| 70      | 15      | 0.629      | 0.27 | -0.05 | 59         | 0.96    |
|         | 20      | 0.473      | 0.22 | -0.04 | 56         | 0.67    |
|         | 25      | 0.352      | 0.20 | -0.01 | 57         | 0.50    |
|         | 30      | 0.261      | 0.20 | 0.04  | 59         | 0.40    |
|         | 35      | 0.190      | 0.20 | 0.07  | 61         | 0.32    |
|         | 40      | 0.135      | 0.20 | 0.11  | 63         | 0.25    |

**Table 4.1 (b) Two-part wedge solutions for inclined reinforcement**  
 $(r_u = 0.25, \delta = 10^\circ, \lambda_s = 1, \theta_2 \geq -\delta)$

| $\beta$ | $\phi'$ | $K_\delta$ | X/H  | Y/H   | $\theta_1$ | $L_R/H$ |
|---------|---------|------------|------|-------|------------|---------|
| 20      | 15      | 0.320      | 1.66 | -0.29 | 38         | 2.64    |
|         | 20      | 0.109      | 1.50 | -0.03 | 24         | 1.84    |
|         | 25      | 0.012      | 1.08 | 0.15  | 26         | 0.63    |
| 25      | 15      | 0.442      | 1.45 | -0.26 | 44         | 2.34    |
|         | 20      | 0.224      | 1.20 | -0.14 | 39         | 1.85    |
|         | 25      | 0.093      | 1.19 | 0.08  | 38         | 1.30    |
|         | 30      | 0.022      | 1.0  | 0.22  | 33         | 0.60    |
| 30      | 15      | 0.527      | 1.24 | -0.22 | 49         | 2.12    |
|         | 20      | 0.316      | 1.00 | 0.18  | 43         | 1.70    |
|         | 25      | 0.174      | 0.99 | 0.01  | 43         | 1.35    |
|         | 30      | 0.084      | 0.97 | 0.13  | 42         | 0.95    |
|         | 35      | 0.028      | 0.83 | 0.21  | 38         | 0.51    |
| 35      | 15      | 0.588      | 1.07 | -0.19 | 52         | 1.97    |
|         | 20      | 0.389      | 0.88 | -0.16 | 47         | 1.55    |
|         | 25      | 0.244      | 0.83 | 0.04  | 46         | 1.28    |
|         | 30      | 0.146      | 0.82 | 0.07  | 46         | 1.01    |
|         | 35      | 0.079      | 0.80 | 0.17  | 45         | 0.71    |
|         | 40      | 0.034      | 0.79 | 0.27  | 44         | 0.41    |
| 40      | 15      | 0.636      | 0.92 | -0.16 | 55         | 1.84    |
|         | 20      | 0.446      | 0.78 | -0.14 | 50         | 1.43    |
|         | 25      | 0.304      | 0.70 | -0.07 | 49         | 1.18    |
|         | 30      | 0.203      | 0.70 | 0.04  | 49         | 0.98    |
|         | 35      | 0.129      | 0.70 | 0.12  | 50         | 0.78    |
|         | 40      | 0.076      | 0.69 | 0.21  | 50         | 0.55    |
| 45      | 15      | 0.673      | 0.79 | -0.14 | 58         | 1.73    |
|         | 20      | 0.494      | 0.68 | -0.12 | 53         | 1.33    |
|         | 25      | 0.355      | 0.60 | 0.08  | 51         | 0.09    |
|         | 30      | 0.253      | 0.60 | 0.01  | 52         | 0.92    |
|         | 35      | 0.177      | 0.59 | 0.09  | 52         | 0.76    |
|         | 40      | 0.119      | 0.59 | 0.16  | 53         | 0.59    |
| 50      | 15      | 0.705      | 0.67 | -0.12 | 60         | 1.64    |
|         | 20      | 0.533      | 0.59 | -0.10 | 55         | 1.25    |
|         | 25      | 0.400      | 0.51 | -0.08 | 53         | 1.01    |
|         | 30      | 0.298      | 0.51 | -0.01 | 54         | 0.85    |
|         | 35      | 0.221      | 0.51 | 0.07  | 55         | 0.72    |
|         | 40      | 0.161      | 0.51 | 0.13  | 56         | 0.59    |
| 55      | 15      | 0.732      | 0.57 | -0.10 | 62         | 1.56    |
|         | 20      | 0.568      | 0.50 | -0.09 | 57         | 1.17    |
|         | 25      | 0.440      | 0.44 | 0.08  | 55         | 0.93    |
|         | 30      | 0.340      | 0.44 | 0.01  | 56         | 0.78    |
|         | 35      | 0.263      | 0.44 | 0.06  | 57         | 0.67    |
|         | 40      | 0.202      | 0.43 | 0.10  | 58         | 0.56    |
| 60      | 15      | 0.756      | 0.48 | -0.08 | 64         | 1.49    |
|         | 20      | 0.598      | 0.43 | -0.08 | 59         | 1.11    |
|         | 25      | 0.476      | 0.37 | -0.07 | 56         | 0.87    |
|         | 30      | 0.378      | 0.36 | -0.02 | 57         | 0.71    |
|         | 35      | 0.302      | 0.36 | 0.03  | 58         | 0.61    |
|         | 40      | 0.241      | 0.36 | 0.08  | 60         | 0.52    |
| 65      | 15      | 0.777      | 0.39 | -0.07 | 66         | 1.43    |
|         | 20      | 0.625      | 0.35 | -0.06 | 60         | 1.05    |
|         | 25      | 0.508      | 0.31 | -0.05 | 58         | 0.81    |
|         | 30      | 0.414      | 0.30 | -0.02 | 59         | 0.66    |
|         | 35      | 0.339      | 0.30 | 0.03  | 61         | 0.55    |
|         | 40      | 0.278      | 0.30 | 0.07  | 62         | 0.47    |
| 70      | 15      | 0.798      | 0.31 | -0.05 | 68         | 1.37    |
|         | 20      | 0.651      | 0.28 | -0.05 | 62         | 0.99    |
|         | 25      | 0.539      | 0.25 | -0.04 | 60         | 0.76    |
|         | 30      | 0.447      | 0.24 | -0.02 | 61         | 0.60    |
|         | 35      | 0.374      | 0.24 | 0.02  | 62         | 0.50    |
|         | 40      | 0.315      | 0.24 | 0.05  | 64         | 0.42    |

**Table 4.1 (c) Two-part wedge solutions for inclined reinforcement**

$$(r_u = 0.5, \delta = 10^\circ, \lambda_s = 1, \theta_2 \geq -\delta)$$

| $\beta$ | $\phi'$ | $K_\delta$ | X/H  | Y/H   | $\theta_1$ | $L_p/H$ |
|---------|---------|------------|------|-------|------------|---------|
| 20      | 15      | 0.678      | 2.27 | -0.40 | 53         | 3.53    |
|         | 20      | 0.422      | 1.87 | -0.33 | 42         | 2.89    |
|         | 25      | 0.233      | 1.66 | -0.19 | 38         | 2.43    |
|         | 30      | 0.108      | 1.65 | 0.30  | 35         | 1.82    |
| 25      | 15      | 0.771      | 1.82 | -0.32 | 58         | 3.19    |
|         | 20      | 0.540      | 1.56 | -0.28 | 48         | 2.58    |
|         | 25      | 0.361      | 1.37 | -0.24 | 43         | 2.19    |
|         | 30      | 0.225      | 1.32 | -0.09 | 42         | 1.87    |
|         | 35      | 0.129      | 1.31 | 0.06  | 40         | 1.47    |
|         | 40      | 0.062      | 1.39 | 0.24  | 40         | 0.99    |
| 30      | 15      | 0.833      | 1.53 | -0.27 | 65         | 2.96    |
|         | 20      | 0.620      | 1.36 | -0.24 | 54         | 2.36    |
|         | 25      | 0.454      | 1.19 | -0.21 | 49         | 1.98    |
|         | 30      | 0.320      | 1.11 | -0.13 | 46         | 1.72    |
|         | 35      | 0.218      | 1.10 | -0.01 | 46         | 1.48    |
|         | 40      | 0.142      | 1.08 | 0.11  | 45         | 1.18    |
| 35      | 15      | 0.880      | 1.31 | -0.23 | 71         | 2.78    |
|         | 20      | 0.677      | 1.17 | -0.21 | 58         | 2.19    |
|         | 25      | 0.523      | 1.05 | -0.19 | 53         | 1.82    |
|         | 30      | 0.396      | 0.93 | -0.15 | 50         | 1.57    |
|         | 35      | 0.294      | 0.94 | -0.04 | 50         | 1.38    |
|         | 40      | 0.214      | 0.93 | 0.05  | 50         | 1.18    |
| 40      | 15      | 0.920      | 1.11 | -0.20 | 76         | 2.64    |
|         | 20      | 0.721      | 1.01 | -0.18 | 62         | 2.06    |
|         | 25      | 0.577      | 0.91 | -0.16 | 57         | 1.70    |
|         | 30      | 0.457      | 0.81 | -0.14 | 53         | 1.45    |
|         | 35      | 0.357      | 0.79 | -0.06 | 53         | 1.26    |
|         | 40      | 0.278      | 0.80 | 0.03  | 53         | 1.12    |
| 45      | 20      | 0.757      | 0.85 | -0.15 | 64         | 1.95    |
|         | 25      | 0.621      | 0.78 | -0.14 | 59         | 1.59    |
|         | 30      | 0.508      | 0.71 | -0.13 | 56         | 1.35    |
|         | 35      | 0.412      | 0.68 | -0.07 | 55         | 1.17    |
|         | 40      | 0.334      | 0.70 | 0.02  | 57         | 1.03    |
| 50      | 20      | 0.786      | 0.74 | -0.13 | 68         | 1.86    |
|         | 25      | 0.657      | 0.67 | -0.12 | 61         | 1.50    |
|         | 30      | 0.551      | 0.61 | -0.11 | 59         | 1.26    |
|         | 35      | 0.460      | 0.59 | -0.07 | 58         | 1.08    |
|         | 40      | 0.384      | 0.60 | 0.01  | 59         | 0.95    |
| 55      | 20      | 0.812      | 0.61 | -0.11 | 70         | 1.78    |
|         | 25      | 0.689      | 0.57 | -0.10 | 64         | 1.43    |
|         | 30      | 0.589      | 0.53 | -0.09 | 61         | 1.19    |
|         | 35      | 0.502      | 0.51 | -0.06 | 60         | 1.01    |
|         | 40      | 0.429      | 0.51 | -0.01 | 61         | 0.88    |
| 60      | 20      | 0.835      | 0.51 | -0.09 | 72         | 1.71    |
|         | 25      | 0.716      | 0.49 | -0.09 | 66         | 1.36    |
|         | 30      | 0.622      | 0.44 | -0.08 | 63         | 1.12    |
|         | 35      | 0.540      | 0.43 | -0.06 | 62         | 0.95    |
|         | 40      | 0.471      | 0.43 | -0.01 | 64         | 0.81    |
| 65      | 20      | 0.857      | 0.43 | -0.08 | 75         | 1.64    |
|         | 25      | 0.742      | 0.40 | -0.07 | 69         | 1.30    |
|         | 30      | 0.652      | 0.37 | -0.06 | 65         | 1.06    |
|         | 35      | 0.576      | 0.35 | -0.06 | 64         | 0.89    |
|         | 40      | 0.510      | 0.36 | -0.01 | 66         | 0.75    |
| 70      | 20      | 0.878      | 0.34 | -0.06 | 79         | 1.58    |
|         | 25      | 0.765      | 0.31 | -0.06 | 70         | 1.24    |
|         | 30      | 0.680      | 0.29 | -0.05 | 67         | 1.00    |
|         | 35      | 0.608      | 0.28 | -0.05 | 66         | 0.83    |
|         | 40      | 0.547      | 0.29 | -0.01 | 68         | 0.70    |

**Table 4.2 Algebraic definitions for case of limited upper slope**

(See Figure 4.7)

|       | Case 1  | Case 2   | Case 3 |
|-------|---|--|--------|
| $W_1$ | subtract: $(\frac{1}{2}\gamma vv kk)$                               | subtract: $(\frac{1}{2}\gamma vv kk)$                          |        |
| $W_2$ |   |  |        |
| $U_1$ | replace with:<br>$\frac{1}{2}\gamma r_u[dd ee + (dd+d)ff + (d+b)f]$ | replace with:<br>$\frac{1}{2}\gamma r_u[dd ee + (H-Y+z+dd)gg]$ |        |
| $U_2$ |   |  |        |
| $K_1$ | subtract: $(c'_1 ww)$   | subtract: $(c'_1 ww)$  |        |
| $K_2$ |   |  |        |
| $Q_1$ | Replace with: $q kk$  | replace with: $q kk$   |        |
| $Q_2$ |   | replace with: Not applicable                                   |        |

|      |                       |      |                     |
|------|-----------------------|------|---------------------|
| $vv$ | $(H + v - H'_{max})$  | $ee$ | $(kk \sec\theta)_1$ |
| $kk$ | $(vv k) / v$          | $ff$ | $(e + w - ee - ww)$ |
| $ww$ | $(vv / \sin\theta)_1$ | $gg$ | $(g + w - ee - ww)$ |
| $dd$ | $(kk \tan\theta)_1$   |      |                     |

- Notes:**
1. See paragraphs 4.23 to 4.30 for explanation.
  2. In case 2, it is assumed that the inter-wedge boundary does not intersect the ground surface above the crest of the upper slope.
  3. If surcharge  $q$  exists on the upper horizontal surface, then this may be taken into account by substituting  $H'_{max}$  for  $H$  in the above, where  $H'_{max} = H + (q/\gamma)_{max}$

## 5. GLOSSARY OF SYMBOLS

|                        |  |
|------------------------|--|
| A                      | Cross-sectional area of reinforcement  |
| b                      | Dimensionless width of reinforcement per unit width of slope<br>(= 1 for continuous reinforcement, e.g. geotextiles, geogrids) |
| BBA                    | British Board of Agrément  |
| c'                     | Effective stress cohesion  |
| c' <sub>1</sub>        | c' <sub>des</sub> acting on base of wedge 1  |
| c' <sub>2</sub>        | c' <sub>des</sub> acting on base of wedge 2  |
| c' <sub>12</sub>       | c' <sub>des</sub> acting on inter-wedge boundary   |
| d <sub>bar</sub>       | Bar diameter   |
| d <sub>hole</sub>      | Hole diameter  |
| f <sub>d</sub>         | Partial factor of safety for mechanical damage before and during installation  |
| f <sub>e</sub>         | Partial factor of safety for environmental effects during design life (chemical and biological)                                |
| f <sub>m</sub>         | Partial factor of safety to cover variabilities and uncertainties in material strength (including extrapolation of data)       |
| f <sub>s</sub>         | Partial factor of safety on soil strength  |
| h                      | Depth of overburden directly above point in question   |
| H                      | Height of slope  |
| H'                     | Effective height of slope including surcharge  |
| H <sub>max</sub>       | Total height of upper slope  |
| ΔH                     | Equivalent height of surcharge (= q/γ)   |
| i                      | Angle of upper slope   |
| J <sub>o</sub>         | Stiffness of reinforcement at end of construction  |
| J <sub>∞</sub>         | Stiffness of reinforcement at end of design life   |
| K <sub>h</sub>         | Horizontal permeability  |
| K <sub>v</sub>         | Vertical permeability  |
| K <sub>1</sub>         | Cohesion force acting on base of wedge 1 (as defined in Figure 2.3)  |
| K <sub>2</sub>         | Cohesion force acting on base of wedge 2 (as defined in Figure 2.3)  |
| K <sub>12</sub>        | Cohesion force acting on inter-wedge boundary (as defined in Figure 2.3)   |
| K <sub>a</sub>         | σ' <sub>h</sub> / σ' <sub>v</sub> (= coefficient of active lateral earth pressure)   |
| K                      | T <sub>max</sub> / 0.5γH <sup>2</sup>  |
| K <sub>δ</sub>         | T <sub>maxδ</sub> / 0.5γH <sup>2</sup>   |
| K <sub>L</sub>         | Coefficient of lateral earth pressure <i>parallel</i> to slope = σ' <sub>L</sub> /σ' <sub>v</sub> (see Figures 2.11 and D.1)   |
| L <sub>B</sub>         | Width of reinforcement zone at base  |
| L <sub>T</sub>         | Width of reinforcement zone at top   |
| L <sub>e</sub>         | Pullout length   |
| L <sub>e<i>i</i></sub> | Pullout length for <i>i</i> <sup>th</sup> layer of reinforcement   |
| L' <sub>e1</sub>       | Revised value of pull-out length for 1st layer of reinforcement  |
| L <sub>ef</sub>        | Front face pull-out length   |
| N                      | Total number of layers of reinforcement, not including basal layer   |
| N' <sub>1</sub>        | Normal effective force on base of wedge 1 (as defined in Figure 2.3)   |
| N' <sub>2</sub>        | Normal effective force on base of wedge 2 (as defined in Figure 2.3)   |
| N' <sub>12</sub>       | Normal effective force on inter-wedge boundary (as defined in Figure 2.3)  |
| P                      | Capacity of a single layer of reinforcement (kN/m)   |
| P <sub>i</sub>         | Load carried by <i>i</i> <sup>th</sup> layer of reinforcement (kN/m)   |
| P <sub>c</sub>         | Long term unfactored reinforcement strength (kN/m)   |
| PI                     | Plasticity index (%)   |
| Q <sub>1</sub>         | Total surcharge force on wedge 1 (as defined on Figure 2.3)  |
| Q <sub>2</sub>         | Total surcharge force on wedge 2 (as defined on Figure 2.3)  |
| q                      | Surcharge (kN/m <sup>2</sup> )   |
| R' <sub>1</sub>        | Tangential effective force on base of wedge 1 (as defined in Figure 2.3)   |
| R' <sub>2</sub>        | Tangential effective force on base of wedge 2 (as defined in Figure 2.3)   |

|                     |  |
|---------------------|--|
| $R'_{12}$           | Tangential effective force on inter-wedge boundary (as in Figure 2.3)  |
| $r_u$               | Pore pressure parameter ( $= u/\gamma h$ )   |
| $S_h$               | Horizontal spacing   |
| $S'_{h1}$           | Revised value of horizontal spacing for 1st layer of reinforcement   |
| $S_v$               | Vertical spacing   |
| $T_{tot}$           | Total reinforcement force (kN/m)   |
| $T_{max}$           | Total reinforcement force for most critical two-part wedge mechanism (kN/m)  |
| $T_{max\delta}$     | Total reinforcement force <i>inclined at angle <math>\delta</math></i> for most critical two-part wedge mechanism (kN/m) |
| $T_o$               | Refers to any two-part wedge mechanism requiring exactly zero total restraining force                                    |
| $T_{ob}$            | $T_o$ mechanism with $\theta_2 = 0$  |
| $T_{o\delta}$       | $T_o$ mechanism with $\theta_2 = -\delta$  |
| $T_1$               | Sum of reinforcement forces acting on wedge 1 (as defined in Figure 2.3)   |
| $T_2$               | Sum of reinforcement forces acting on wedge 2 (as defined in Figure 2.3)   |
| $T_{12}$            | Inter-wedge reinforcement force (as defined in Figure 2.3)   |
| $u$                 | Porewater pressure (kN/m <sup>2</sup> )  |
| $U_1$               | Porewater force acting on base of wedge 1 (as defined in Figure 2.3)   |
| $U_2$               | Porewater force acting on base of wedge 2 (as defined in Figure 2.3)   |
| $U_{12}$            | Porewater force acting on interwedge boundary (as defined in Figure 2.3)   |
| $W_1$               | Weight of wedge 1 (as defined in Figure 2.3)   |
| $W_2$               | Weight of wedge 2 (as defined in Figure 2.3)   |
| $X$                 | x coordinate of two-part wedge node (as defined on Figure 2.1)   |
| $Y$                 | y coordinate of two-part wedge node (as defined on Figure 2.1)   |
| $z_i$               | Depth to $i^{\text{th}}$ layer of reinforcement below crest of slope   |
| $\alpha$            | Interface sliding factor ( $= \tan \phi'_{int}/\tan \phi'_{des} = c'_{int}/c'_{des}$ )                                   |
| $\alpha'$           | Pull-out <i>bearing</i> factor for geogrids  |
| $\beta$             | Slope angle  |
| $\delta$            | Angle of inclined reinforcement  |
| $\delta_{ho}$       | Horizontal elongation of reinforcement at end of construction  |
| $\Delta\delta_{ho}$ | Horizontal elongation of reinforcement occurring after construction  |
| $\phi'$             | Effective angle of friction  |
| $\phi'_1$           | $\phi'_{des}$ acting on base of wedge 1  |
| $\phi'_2$           | $\phi'_{des}$ acting on base of wedge 2  |
| $\phi'_{12}$        | $\phi'_{des}$ acting on inter-wedge boundary   |
| $\gamma$            | Unit weight of soil (kN/m <sup>3</sup> )   |
| $\gamma_w$          | Unit weight of water (kN/m <sup>3</sup> )  |
| $\lambda_p$         | Pull-out factor (Figure 2.13)  |
| $\lambda_s$         | Base sliding factor (Figure 2.13)  |
| $\eta$              | Nail plate bearing factor (see Figure E.2)   |
| $\psi$              | Angle of dilation  |
| $\sigma'_h$         | Horizontal effective stress  |
| $\sigma'_v$         | Vertical effective stress  |
| $\sigma'_L$         | Lateral effective stress <i>parallel</i> to slope (see Figures 2.11 and D.1)   |
| $\sigma'_n$         | Average radial effective stress acting on bar  |
| $\sigma_y$          | Yield strength   |
| $\tau$              | Shear stress   |
| $\theta_1$          | Base angle of wedge 1  |
| $\theta_2$          | Base angle of wedge 2 ( $= \tan^{-1} Y/X$ )  |
| $\theta_{12}$       | Angle of inter-wedge boundary  |
| $\zeta$             | Inclined reinforcement factor  |
| av                  | Subscript denoting average   |
| cv                  | Subscript denoting constant volume strength parameter (Figure 2.5)   |
| des                 | Subscript denoting value for design purposes   |
| int                 | Subscript denoting interface sliding at large displacement   |

|     |   |
|-----|---|
| mob | Subscript denoting mobilised value                          |
| pk  | Subscript denoting peak strength                            |
| r   | Subscript denoting residual strength parameter (Figure 2.5) |

## 6. REFERENCES

1. BD2 "Technical Approval of Highway Structures on Motorways and Other Trunk Roads Part I: General Procedures." (DMRM1.1).
2. Bishop AW and Morgenstern N (1960) "Stability Coefficients for Earth Slopes", *Geotechnique*, Vol 10, pp 129-150.
3. Bolton MD (1986) "Strength and Dilatancy of Sands", *Geotechnique*, Vol 36, No 1, pp 65-78.
4. Burd HJ, Yu HS and Houlsby GT (1989) "Finite Element Implementation of Frictional Plasticity Models with Dilation", *Procs. Int. Conf. on Constitutive Laws for Eng. Materials*, Asia, Chongqing, China, Aug 1989.
5. Caquot A and Kerisel J (1948) "Tables for the Calculation of Passive Pressure, Active Pressure and Bearing Capacity of Foundations", Gauthier-Villars, Paris.
6. CIRIA RP396 (in preparation) "Use of Geotextiles in Ground Engineering", Author: RA Jewell, CIRIA.
7. Cornforth DH (1973) "Prediction of Drained Strength of Sands from Relative Density Measurements", *ASTM, Spec. Tech. Publ. 523*, pp 281-303.
8. HA43 "Geotechnical Considerations and Techniques for Widening Highway Earthworks", (DMRB 4.1).
9. HD22 "Ground Investigation and Earthworks. Procedure for Geotechnical Certification", (DMRB 4.1.2).
10. Hight DW (1983) "Laboratory Investigations of Sea-bed Clays", PhD Thesis, Imperial College of Science and Technology, London.
11. Jewell RA, Paine N and Woods RI (1984) "Design Methods for Steep Reinforced Embankments", *Polymer Grid Reinforcement*, Thomas Telford, pp 18-30.
12. Jewell RA (1990) "Revised Design Charts for Steep Reinforced Slopes", *Proc. Symp. Reinforced Embankments - Theory and Practice*, Cambridge, Thomas Telford, Paper No 1.
13. Mitchell RJ (1983) "Earth Structures Engineering", Allen and Unwin Inc., Boston.
14. Sokolovski VV (1965) "Statics of Granular Media", Pergamon Press, N.Y.
15. RR 380 TRL Research Report (1993). "The Development of Specifications for Soil Nailing" - by R T Murray.
16. Specification for Highway Works (MCHW1).
17. US Federal Highway Administration (1993) "Recommendations Clouterre 1991" English Translation.



## 7. ENQUIRIES

All technical enquiries or comments on this Advice Note should be sent in writing as appropriate to:-

Head of Highways Engineering Division  
The Department of Transport  
St Christopher House  
Southwark Street  
London SE1 0TE

N S ORGAN  
Head of Highways Engineering  
Division

The Deputy Chief Engineer  
Scottish Office Industry Department  
New St Andrews House  
Edinburgh  
EH1 3TA

J INNES  
Deputy Chief Engineer

Head of Roads Engineering (Construction) Division  
Welsh Office  
Y Swyddfa Gymreig  
Government Buildings  
Ty Glas Road  
Llanishen  
Cardiff CF4 5PL

B H HAWKER  
Head of Roads Engineering  
(Construction) Division

Superintending Engineer Works  
Department of the Environment for  
Northern Ireland  
Commonwealth House  
Castle Street  
Belfast BT1 1GU

D O'HAGAN  
Superintending Engineer (Works)

Orders for further copies should be addressed to:

DOE/DTP Publications Sales Unit  
Government Building  
Block 3, Spur 2  
Lime Grove  
Eastcote HA4 8SE

Telephone N°: 081 429 5170

## THE TWO-PART WEDGE MECHANISM

- A1. The two-part wedge and the log-spiral failure mechanisms have been found to be particularly suited to the analysis of reinforced soil. The log-spiral is kinematically superior to the two-part wedge, however the latter yields many benefits of simplicity. The two-part wedge with full inter-wedge friction ( $\phi'_{12} = \phi'$ ) and full freedom of the inter-wedge angle,  $\theta_{12}$  has been shown to give an unsafe solution compared to the log-spiral (Jewell, 1990), whereas the two-part wedge with  $\phi'_{12} = 0$  and  $\theta_{12} = 90^\circ$  gives a safe solution, by approximately 10 - 25% in terms of reinforcement density, and approximately 5-10% in terms of reinforcement length.
- A2. The benefits of adopting the two-part wedge are:
- the two-part wedge with  $\phi'_{12}=0$ ,  $\theta_{12}=90^\circ$  always yields safe solutions.
  - scope exists to provide more exact solutions by adjusting the value of  $\phi'_{12} / \phi'$ , if required (see below).
  - simple check hand-calculations may be carried out; other design approaches using the relatively complicated log-spiral equations are not amenable to hand calculations.
  - the two-part wedge can better model direct sliding on a basal layer of reinforcement.
  - the mechanism is intuitive, whereas the log-spiral mechanism is not and requires more operator skill.
- A3. The effect of the magnitude of the inter-wedge friction,  $\phi'_{12}$  is demonstrated in Figure A.1 (for  $\theta_{12} = 90^\circ$ ), where curves for  $\phi'_{12}/\phi' = 0, 1/2, 1$  are given. Log-spiral solutions (Jewell, 1990) are also shown, with limited data from other published solution methods (Sokolovski 1965, Caquot and Kerisel 1948). It will be seen that taking  $\phi'_{12} = 0$  is always safe, taking  $\phi'_{12} = \phi'$  is always unsafe, but for most cases  $\phi'_{12} = \phi'/2$  yields reasonably close agreement with the other solutions. While it may in some instances be desirable to take advantage of setting  $\phi'_{12} = \phi'/2$ , this considerably increases the complexity of the calculations, offsetting the advantages of simplicity that the two-part wedge offers, since the *distribution* of the reinforcement force must be assumed.
- A4. Two expressions for the value of  $N'_{12}$  (see Figure 2.3) may be derived, one for each wedge (assuming horizontal reinforcement,  $\delta=0$ , for the moment):

Wedge 1

$$N'_{12} = \frac{(W_1+Q_1-K_{12})(\sin\theta_1 - \cos\theta_1 \tan\phi'_1) - (T_1 - T_{12} + U_{12})(\cos\theta_1 + \sin\theta_1 \tan\phi'_1) + U_1 \tan\phi'_1 - K_1}{(\cos\theta_1 + \sin\theta_1 \tan\phi'_1) + (\sin\theta_1 - \cos\theta_1 \tan\phi'_1) \tan\phi'_{12}}$$

Wedge 2

$$N'_{12} = \frac{-(W_2+Q_2+K_{12})(\sin\theta_2 - \lambda_s \cos\theta_2 \tan\phi'_2) + (T_{12} + T_2 - U_{12})(\cos\theta_2 + \lambda_s \sin\theta_2 \tan\phi'_2) - U_2 \lambda_s \tan\phi'_2 + \lambda_s K_2}{(\cos\theta_2 + \lambda_s \sin\theta_2 \tan\phi'_2) + (\sin\theta_2 - \lambda_s \cos\theta_2 \tan\phi'_2) \tan\phi'_{12}}$$

Appendix A

A5. For limit equilibrium the two expressions must be equal. This then yields a single equation with three unknowns ( $T_1$ ,  $T_2$  and  $T_{12}$ ). Thus, in order to derive the total required reinforcement force ( $T_1 + T_2$ ), an assumption has to be made regarding the relative magnitudes of  $T_1$ ,  $T_2$  and  $T_{12}$  (Figure A.2), for example  $T$  increases linearly or parabolically with depth. An alternative simplifying assumption, which was used in the preparation of Figure A.1, is that all the reinforcement force is carried on wedge 2 (ie.  $T_1 - T_{12} = 0$ ). This is a reasonable assumption when the inter-wedge boundary is at or near the crest. The base sliding factor,  $\lambda_s$ , in the above general formulae takes the value of unity except when  $\theta_2 = 0$ .

A6. If, however, the value of  $\phi'_{12}$  is set to zero, it will be seen that the greatly simplified expression below may be obtained, where the relative magnitudes of  $T_1$ ,  $T_2$  and  $T_{12}$  do not need to be known *a priori*:

$$(T_1 + T_2)_{\text{horiz}} = \frac{[W_1(\tan\theta_1 - \tan\phi'_1) + (U_1 \tan\phi'_1 - K_1)/\cos\theta_1]}{(1 + \tan\theta_1 \tan\phi'_1)} + \frac{[W_2(\tan\theta_2 - \lambda_s \tan\phi'_2) + \lambda_s (U_2 \tan\phi'_2 - K_2)/\cos\theta_2]}{(1 + \lambda_s \tan\theta_2 \tan\phi'_2)}$$

(The above formula is for zero surcharge and zero  $K_{12}$  for extra simplicity, although these are not requirements.)

A7. In the case of inclined reinforcement (soil nails) the two expressions for  $N'_{12}$  become slightly more complicated (where  $\lambda_s$  takes the value of unity except where  $\theta_2 = -\delta$ ):

Wedge 1

$$N'_{12} = \frac{[(W_1 + Q_1 - K_{12})(\sin\theta_1 - \cos\theta_1 \tan\phi'_1) - (T_1 - T_{12})(\cos[\theta_1 + \delta] + \sin[\theta_1 + \delta] \tan\phi'_1) - U_{12}(\cos\theta_1 + \sin\theta_1 \tan\phi'_1) + U_1 \tan\phi'_1 - K_1]}{[(\cos\theta_1 + \sin\theta_1 \tan\phi'_1) + (\sin\theta_1 - \cos\theta_1 \tan\phi'_1) \tan\phi'_{12}]}$$

Wedge 2

$$N'_{12} = \frac{[-(W_2 + Q_2 + K_{12})(\sin\theta_2 - \lambda_s \cos\theta_2 \tan\phi'_2) + (T_{12} + T_2)(\cos[\theta_2 + \delta] + \lambda_s \sin[\theta_2 + \delta] \tan\phi'_2) - U_{12}(\cos\theta_2 + \lambda_s \sin\theta_2 \tan\phi'_2) - U_2 \lambda_s \tan\phi'_2 + \lambda_s K_2]}{[(\cos\theta_2 + \lambda_s \sin\theta_2 \tan\phi'_2) + (\sin\theta_2 - \lambda_s \cos\theta_2 \tan\phi'_2) \tan\phi'_{12}]}$$

A8. Thus the measure of setting  $\phi'_{12} = 0$  is not enough to yield a simplified equation independent of the distribution of  $T_1$ ,  $T_2$  and  $T_{12}$ . For the sake of simplicity, the conservative assumption that all the reinforcement force acts on Wedge 1 (ie that  $T_2 = T_{12} = 0$ ) is therefore also recommended. As a result the value of required *inclined* reinforcement force  $(T_1 + T_2)_\delta$  becomes a simple function of that required if the reinforcement were placed horizontally  $(T_1 + T_2)_{\text{horiz}}$  for the same slope:

$$(T_1 + T_2)_\delta = \zeta \cdot (T_1 + T_2)_{\text{horiz}}$$

$$\text{where } \zeta = [\cos(\theta_1 - \phi'_1) / \cos(\theta_1 - \phi'_1 + \delta)]$$

This is always a conservative assumption since  $\theta_1$  is always bigger than  $\theta_2$ , however it may in some cases be excessively conservative. In such instances it may be desirable to iterate a solution to get a less conservative design which takes account of the actual distribution of  $T_1$ ,  $T_2$  and  $T_{12}$ .

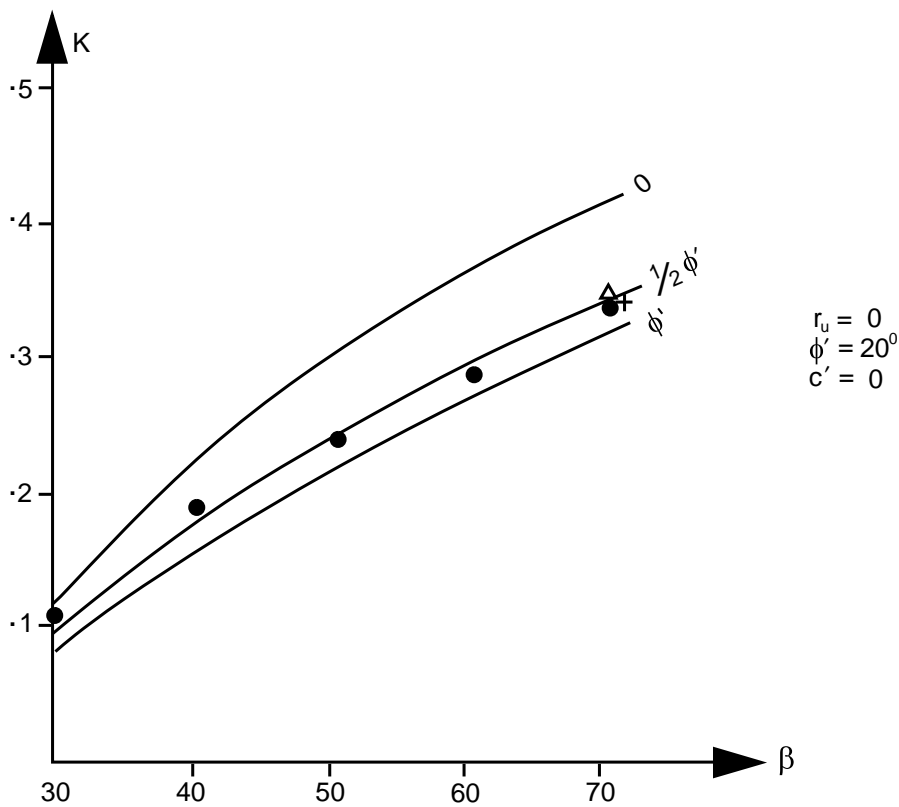
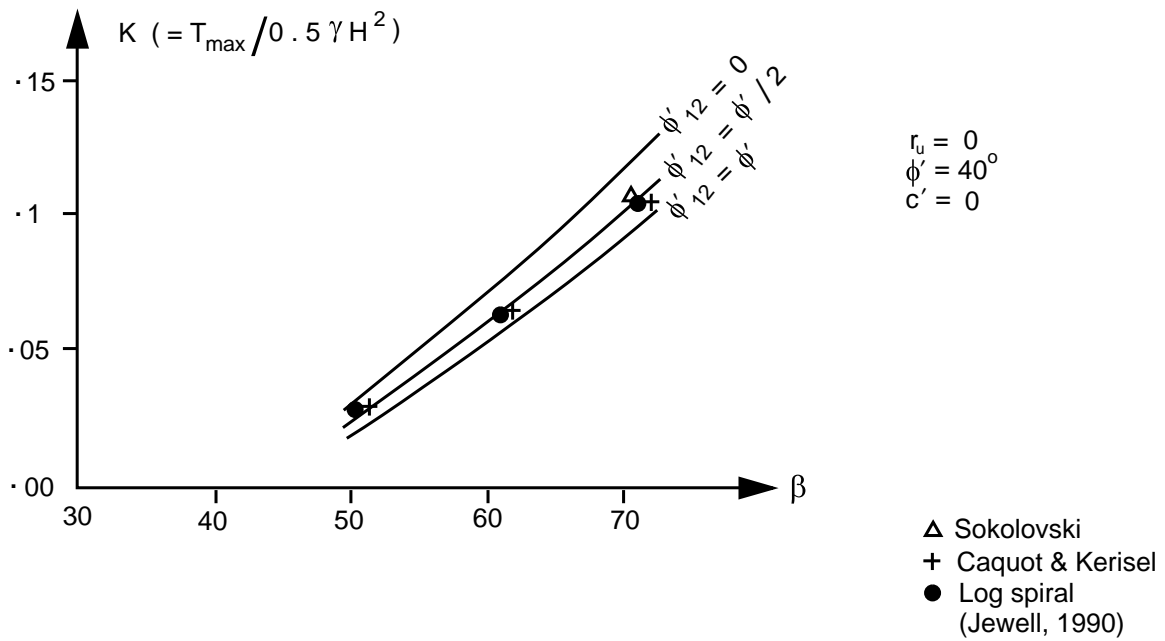

Figure A.1 Effect of inter-wedge friction angle  $\phi'_{12}$

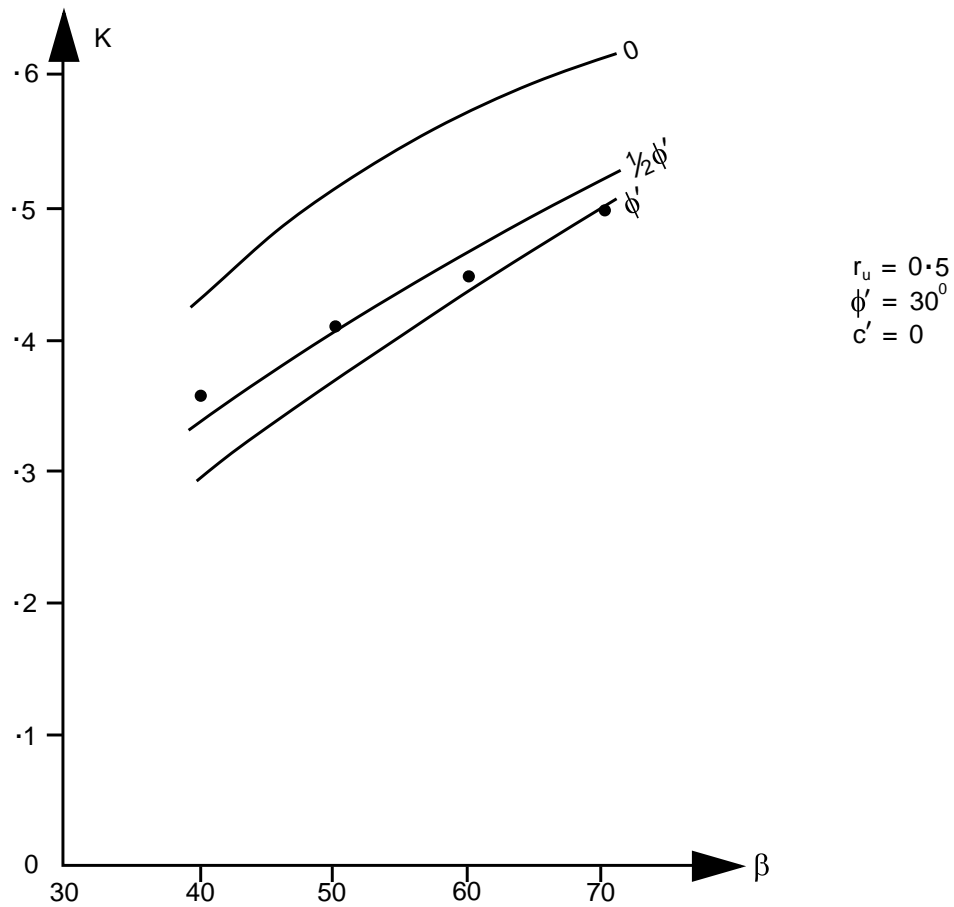
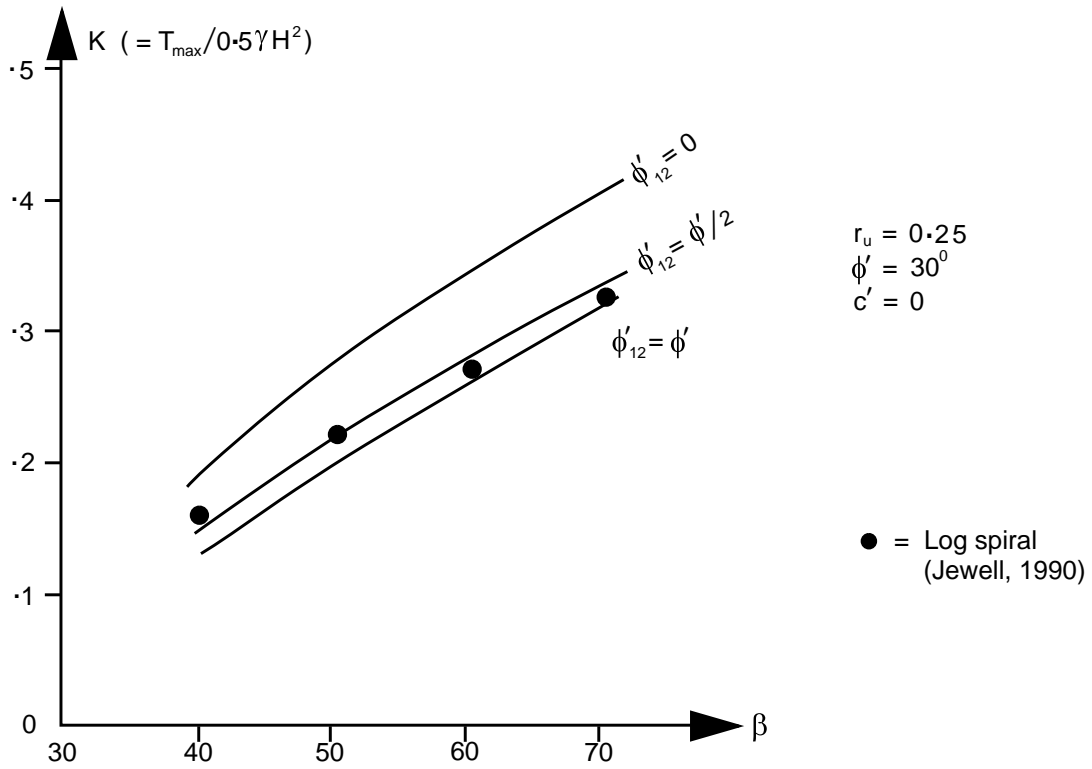

Figure A.1 (Cont.)

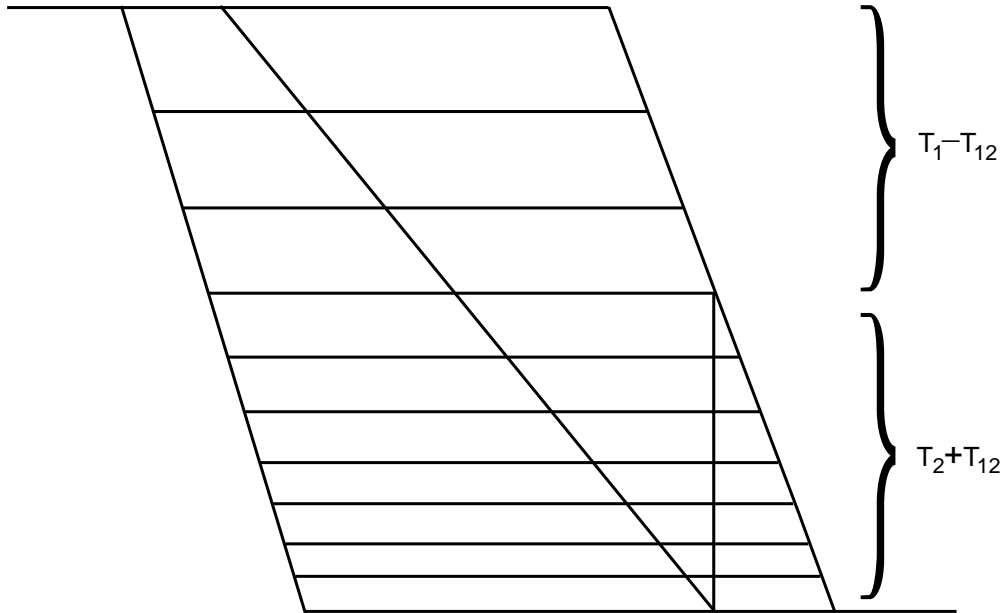

Figure A.2 Definition of reinforcement forces acting on each wedge

## NON-COMPETENT FOUNDATION MATERIAL

- B.1 It is assumed in the design approach given in the text that the underlying foundation material is stronger than the overlying embankment or cutting material. As such, the emphasis in the design method is to explore two-part wedge failure mechanisms which outcrop at the toe of the slope, which do not penetrate into the underlying foundation. However, in cases where the underlying foundation material is *no better* than the embankment or the cutting material above it, then these restrictions should be lifted, and underlying failure mechanisms such as those shown in Figure 4.3 passing through the foundation material should also be considered. It should be noted that the charts contained in Tables 3.1 and 4.1 representing two-part wedge mechanisms passing through the toe of the slope have been limited to the case of  $\theta_2 \geq 0$  and  $\theta_2 \geq -\delta$  respectively, and restrictions on  $\theta_2$  should therefore also be lifted. However, it has been found that where the  $T_{\max}$  (or  $T_{\max\delta}$ ) mechanism has a negative value of  $\theta_2$  then the associated 3-block sliding mechanism (Figure B.1) will always be more critical than the two-part wedge mechanism, and should also be checked. To do this simply, the third block in the limit equilibrium calculation may be substituted by a passive pressure as shown in the lower part of Figure B.1. The angle of interface friction should be taken as zero between blocks 1 and 2 (as for the equivalent two-part wedge mechanism), but may be assumed to take the full value of  $\phi'$  in the calculation of passive pressure for block 3 (Figure B.1). The more dramatic underlying 3-block mechanisms are for the lower angles of  $\phi'$  ( $\phi' \leq 25^\circ$ ) when bearing capacity would however be a problem anyway.
- B.2 Bearing capacity of the reinforced zone should be checked, assuming it to act as a rigid gravity retaining structure. The distribution of vertical stress acting on the foundation beneath may be taken to be simply uniform and equal to  $\gamma H$  (Figure B.2).
- B.3 It should also be checked that horizontal spreading of the underlying foundation soil is not overstraining the basal layers of reinforcement.

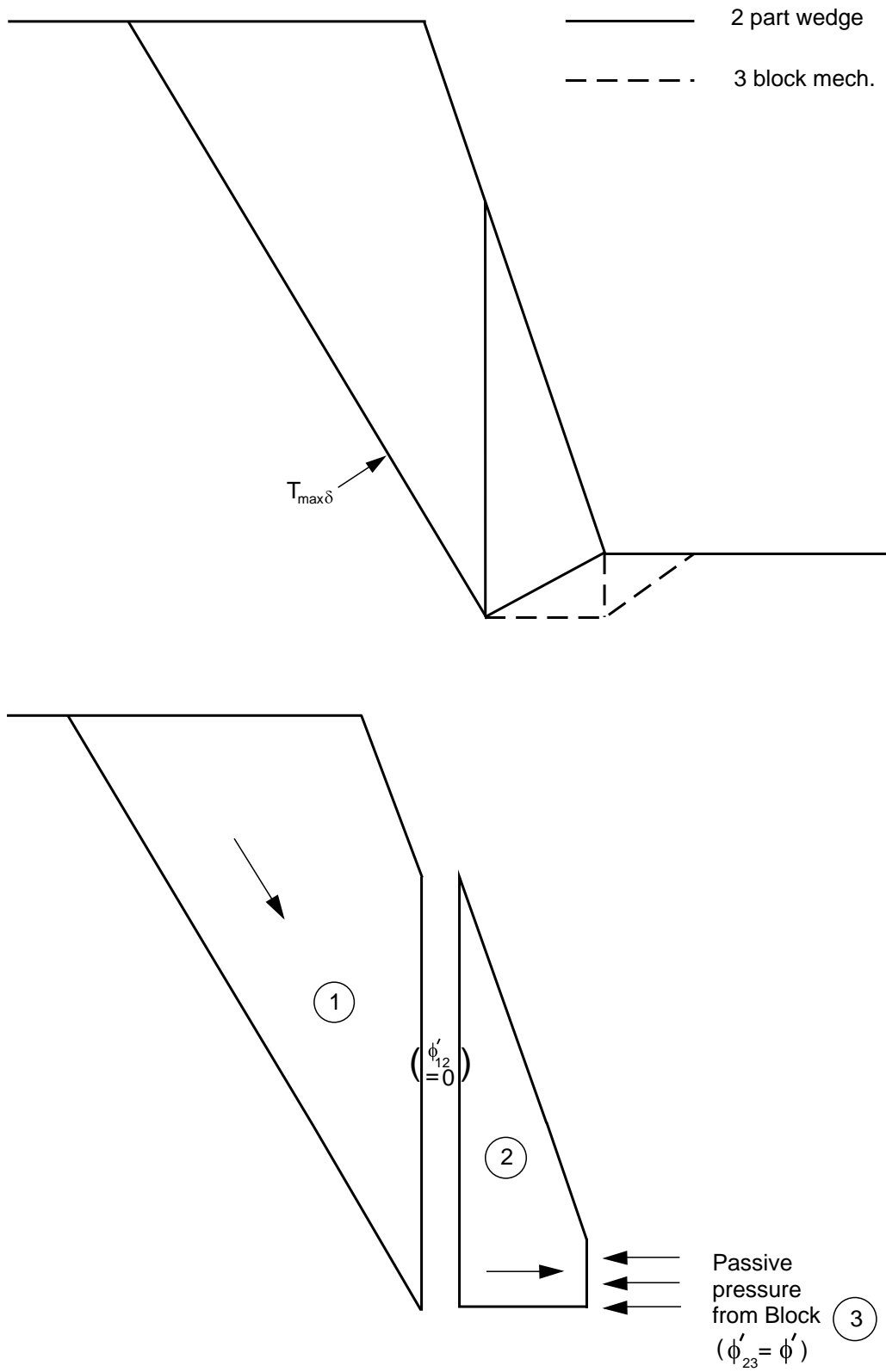

Figure B.1 Underlying 3-Block sliding mechanisms



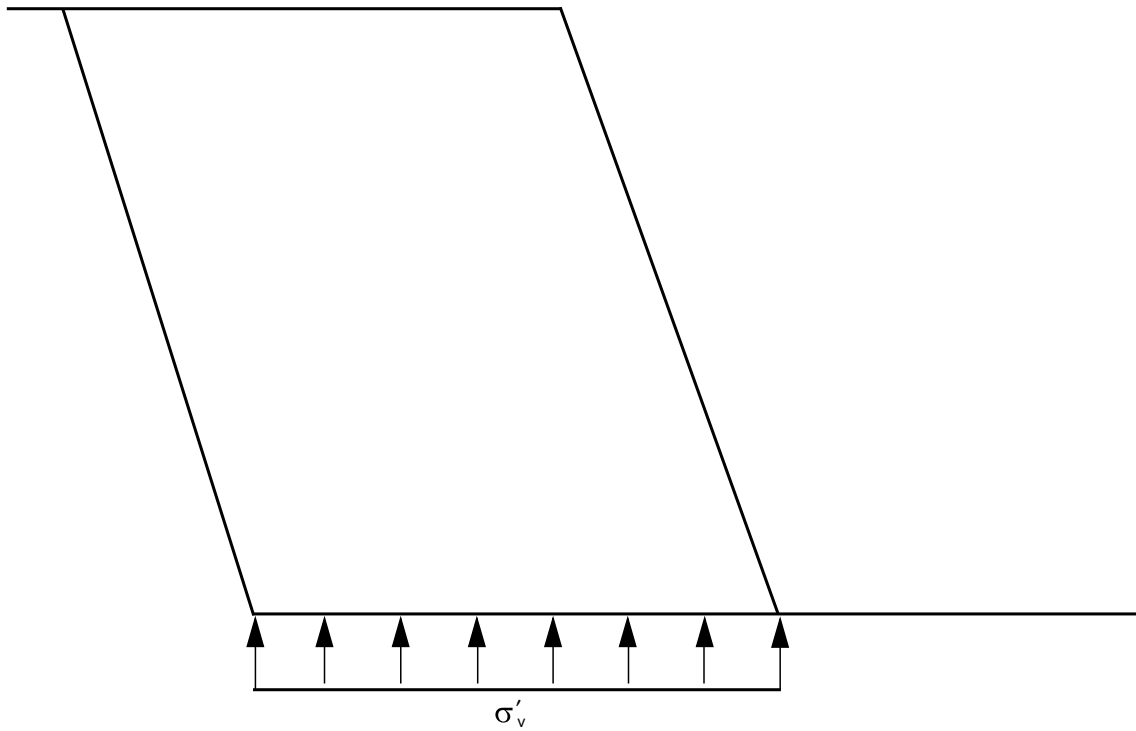

Figure B.2 Uniform distribution of vertical effective stress acting on underlying foundation

# CORROSION OF METALLIC REINFORCEMENT AND SOIL NAILS

- C.1 The partial factors of safety ( $f_d$ ,  $f_e$ ,  $f_m$ ) to be applied in the calculation of the design load,  $P_{des}$  for metallic reinforcement and soil nails depend on whether corrosion protection is provided. The requirement for corrosion protection depends on the classification of soil aggressivity. Advice on the ranking values and the assessment of soil conditions are given in RR 380 (TRL, 1993). If the soil is classified as highly aggressive, soil nails or metallic reinforcement are not recommended.
- C.2 Corrosion protection barriers may take the form of:
- galvanising or other protective coating
  - grout annulus
  - corrugated sheath within grout annulus
- C.3 If adequate corrosion protection in one of the forms above is provided, then relatively low partial factors would be appropriate (in the range 1.0 - 1.1).
- C.4 If no protection barrier is provided, then the effects of long term corrosion of the steel should be allowed for in the form of sacrificial cross-sectional area. For example, a sacrificial thickness of 1mm on the radius of a 16mm diameter bar would be satisfied by a partial factor of safety,  $f_e$ , of 1.3. Similarly, higher values of  $f_d$  and  $f_m$  should be taken.

## THE CALCULATION OF PULL-OUT RESISTANCE OF SOIL NAILS

D.1 The general formula for the calculation of pull-out resistance of soil nails is given in paragraph 2.23. The average radial effective stress,  $\sigma'_n$ , acting along the pull-out length of a soil nail may be derived from:

$$\sigma'_n = \frac{1}{2} (1 + K_L) \sigma'_v$$

where:

$$\begin{aligned} \sigma'_v &= \text{average vertical effective stress, calculated mid-way along nail pull-out length} \\ K_L &= \text{coefficient of lateral earth pressure } \textit{parallel} \text{ to slope} \end{aligned}$$

D.2 If active conditions (ie.  $\sigma'_h = K_a \sigma'_v$ ) are assumed to develop *perpendicularly* to the slope (see Figure D.1), then it may be shown, for a given yield criterion and flow rule (Burd, Yu and Houlsby, 1989) and conditions of plane strain *parallel* to the slope, and zero dilation (a conservative assumption), that:

$$K_L = \frac{1}{2} (1 + K_a)$$

The value of  $K_a$  may be taken as  $(1 - \sin\phi'_{des}) / (1 + \sin\phi'_{des})$ .

D.3 The equation given above for  $\sigma'_n$  may underestimate the in-service value for granular soils, as a result of the beneficial effects of dilation. If it can be demonstrated by site trials under realistic and well understood boundary conditions that this is so, then higher values of  $P_{des}$  may be used, based on the results of the trials.

D.4 In soils with appreciable cohesion ( $c' \geq 0$ ),  $\sigma'_n$  may in some cases be significantly *less* than given by the above equation, as a result of arching of the soil around the drilled hole. For these soils it is recommended that the design values are checked by a *drained* pull-out trial on site, or that the nails are pressure grouted or an expanding grout used. It should be noted that drained pull-out tests in clays may take several days to complete, in order to ensure fully drained conditions. In the case of cohesive soils with  $PI > 25\%$ , a judgement should be made as to whether sufficient relative displacement is likely to take place between soil and nails under working loads to generate residual angles of friction. This will depend on how realistic the chosen value of  $\phi'_{des}$  is and the extensibility of the nails. For relatively inextensible metallic soil nails and a realistic value of  $\phi'_{des} = \phi'_{cv}$ , then movements are likely to be small and pull-out strength may be calculated on the basis of  $\phi'_{int} = \phi'_{int cv}$ . Otherwise  $\phi'_{int}$  should be based on the residual angle of interface friction,  $\phi'_{int r}$ .

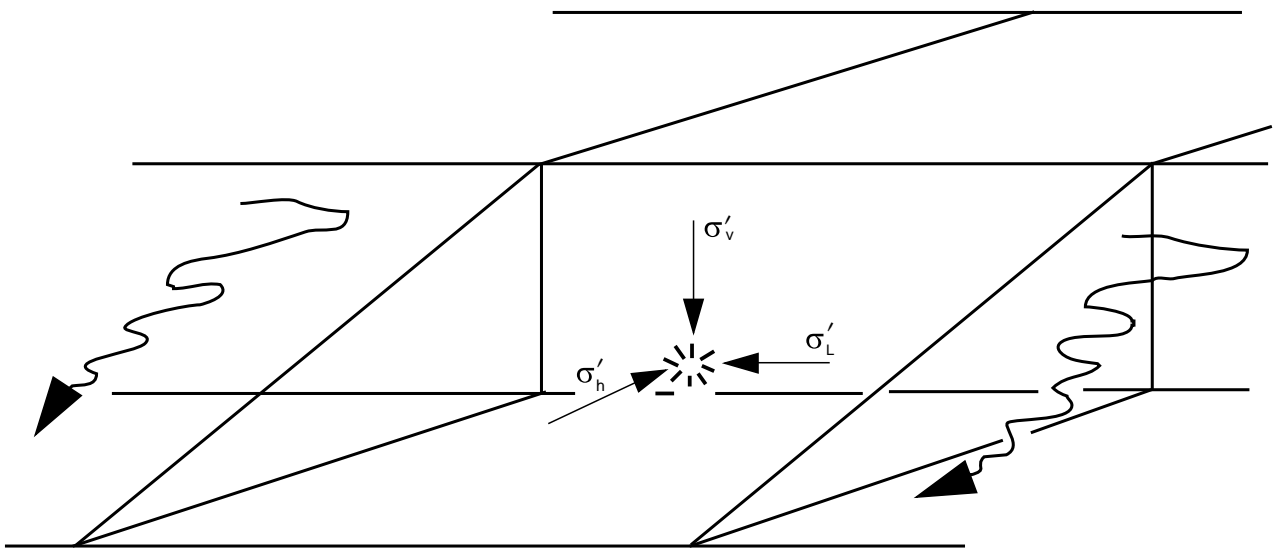

- $\sigma'_v$  = vertical effective stress
- $\sigma'_h$  = horizontal effective stress perpendicular to slope
- $\sigma'_L$  = horizontal effective stress parallel to slope

Figure D.1 Definition of 3 - D stresses acting within slope

## FRONT-FACE PULL-OUT IN THE ABSENCE OF FACING ELEMENTS OR WRAP-ROUND REINFORCEMENT

- E.1 In the case of non-wrap-around geosynthetic construction, or in the case of reinforcement where no other form of facing is provided, the pull-out resistance of reinforcement layers should be checked both forwards and backwards from the failure surface (Figure E.1). For front face pull-out, the average vertical effective stress,  $\sigma'_{vf}$ , will be less than for the standard case,  $\sigma'_v$ , due to the sloping face (see Figure E.1). The relevant expressions are given in Figure E.1.
- E.2 In the case of soil nailing, if no facing is provided (eg no shotcrete and mesh) then the adequacy of the nail plate in bearing should be checked, in order to guard against front face pull-out. Figure E.2a shows a lower bound solution for the plate at failure. For example, for a  $70^\circ$  slope,  $r_u = 0.15$ ,  $\delta = 10^\circ$ ,  $\phi' = 35^\circ$ ,  $\gamma = 20\text{kN/m}^3$  then  $\eta = 469$ , and if  $P_{des} = 25\text{kN/m}$  then a plate of dimensions  $376\text{mm} \times 376\text{mm}$  would be required. This expression is conservative in that it is 2-dimensional and ignores side friction. Alternatively, upper bound mechanisms may be postulated such as a two-part wedge acting passively, as shown in Figure E.2b (Equation 1, paragraph 2.9, may be used by substituting negative values of  $\phi'$ ). This latter mechanism is likely to be of most use for shallower slope angles,  $\beta$ .
- E.3 An allowance for the pull-out resistance of the free length of nail may also be taken into account, but this is likely to be only a small effect since the most critical local mechanism should be considered (Figure E.2c).
- E.4 It should be noted that if adequately sized plates are provided as described above, there will still be parts of the front face (between nail plates) which will be free to "slough" (Figure E.3). Some superficial netting held by relatively short pins may be required. It is this consideration which is likely to dictate the practical upper limit to vertical and horizontal nail spacings ( $S_v$ ,  $S_h$ ). In any case  $S_v$  should not exceed 2m, and  $S_h$  should not exceed the maximum value of  $S_v$ . Good contact with the soil behind the plate should be provided in order to prevent unravelling.

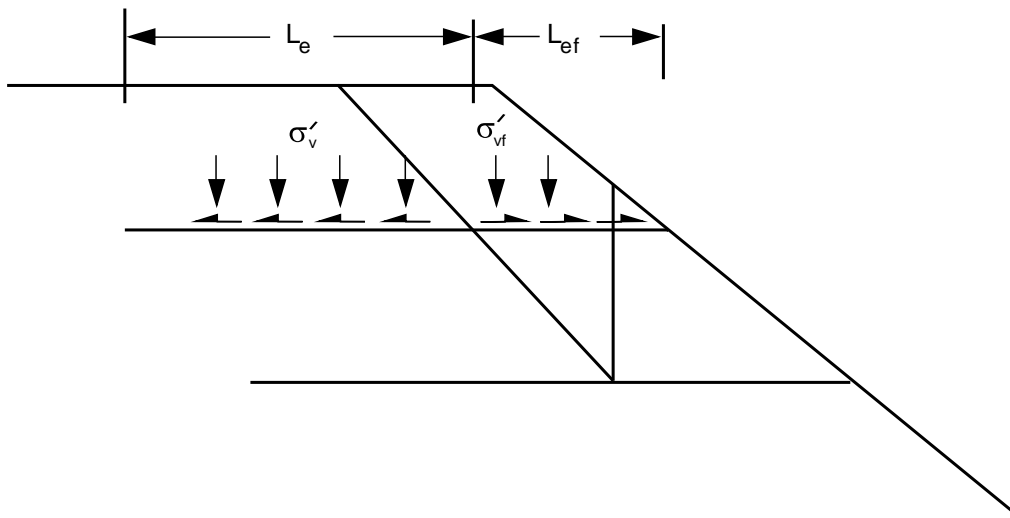

Standard pull - out

$$P_{des} = \lambda_p L_e (\sigma'_v \tan \phi'_{des} + C'_{des})$$

Front face pull - out

$$P_{des} = \lambda_p L_{ef} (\sigma'_{vf} \tan \phi'_{des} + C'_{des})$$

Figure E.1 Front face pull - out definitions

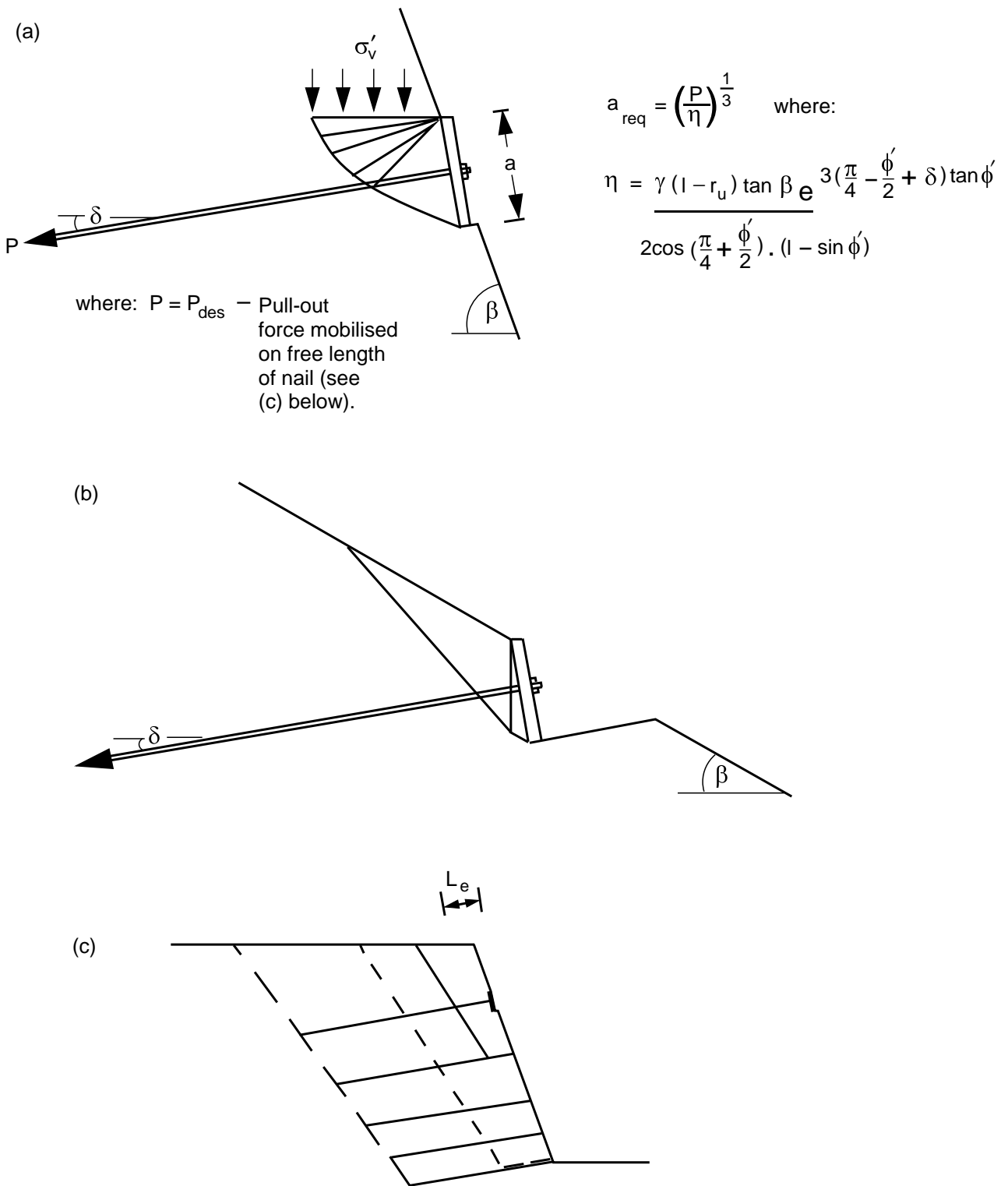

Figure E.2 Nail plate bearing capacity

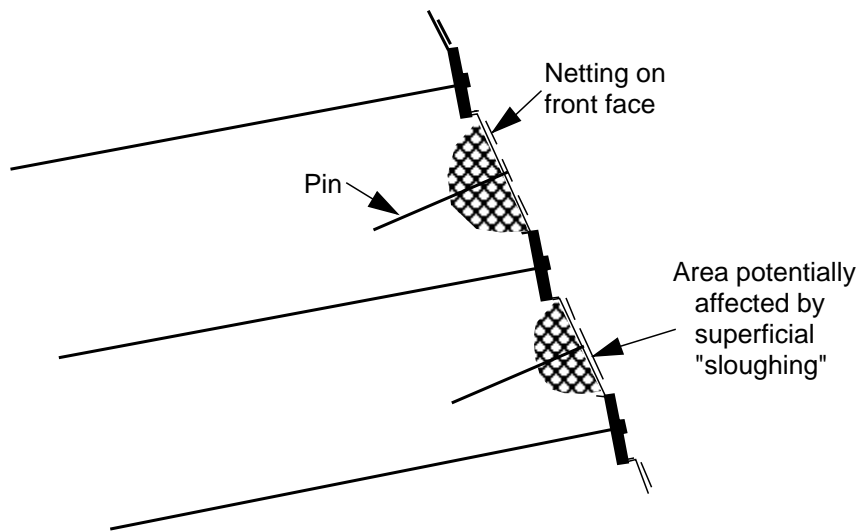

Figure E.3 Surface protection between nail plates



# OPTIMUM VERTICAL LAYER SPACING

- F.1 The philosophy of reinforcement layer vertical spacing is demonstrated in Figure F.1 . The requirement to prevent local over-stressing of any layer of reinforcement (which could lead to progressive failure) gives rise to the spacing requirement shown in Figure F.1a for reinforcement layers of identical capacity, P. The parabolic increase in required total reinforcement force leads to the diminishing layer spacings shown. The curve could also be used to deduce the required layer spacings for a reinforcement layout which may have changing capacity with depth (eg stronger layers at the bottom).
- F.2 It may be seen that the spacings are such that each layer of reinforcement is just able to cope locally. Since each reinforcement layer is put in at the depth at which it *starts* to be needed, the incremental force with which each successive layer of reinforcement is associated is given by (see Figure 3.3):

$$P_i = 0.5 \gamma K [ z_{(i+1)}^2 - z_i^2 ]$$

which simplifies to:

$$P_i = \gamma(z_i + \frac{1}{2}S_{vi})K S_{vi}$$

$$= \sigma_{vi} K S_{vi}$$

where

$$K = T_{max} / \frac{1}{2}\gamma H^2$$

and

$$z_i = \left[ \sqrt{(i-1)/N} \right] H$$

- F.3 Confirmation of the above expression comes from consideration of internal two-part wedge failure mechanisms which outcrop at points above the toe of the slope (Figure F.1b). For any given slope the  $T_{max}$  mechanism may be found (eg Tables 3.1 and 4.1). The  $T_{max}$  mechanism outcrops at the toe of the slope, however, and only dictates the gross quantity of reinforcement force required for stability of the slope, height H. The  $T_{max}$  mechanism does not help to define the required *distribution* of the reinforcement. However, by considering a reduced scale mechanism, geometrically similar to the  $T_{max}$  mechanism (i.e. a "mini"  $T_{max}$  mechanism, Figure F.1b), outcropping at a depth z from the crest of the slope (where  $z < H$ ), it will be found that the required force to prevent failure by this mechanism will be  $(z/H)^2 \cdot T_{max}$ . For example, if there are, say, 10 layers of reinforcement in a slope then the depth to the second layer,  $z_2$ , would be given by :

$$z_2 = \sqrt{[(2-1)/(10-1)]} \cdot H$$

$$= H / 3$$

(the basal layer on which the mechanism is sliding in both cases being ignored for the purposes of this exercise).

- F.4 It is stressed that each layer of reinforcement needs to be inserted at the depth where it *starts* to be required. The only exception to this rule is the first layer of reinforcement which logically should be placed at zero depth, since this would result in zero pull-out capacity (at least, for the case of  $i = 0$ ), the first layer must be inserted at some greater depth,  $z_1$ . In Figure F.1 and Table 3.2 it is arbitrarily placed at  $z_1 = \frac{1}{2} z_2$ . If i is appreciable it may be possible to place the first layer nearer the crest, if not at the crest. (In the case of soil nailing, it may be practical to place the top layer of nails at a steeper angle than the rest in order to make up for low pull-out resistance).

**Appendix F**

---

F.5 The optimum spacing arrangement (for layers of reinforcement of equal capacity per metre width of slope) may therefore be defined simply from the following general expression for the depth to the  $i^{\text{th}}$  layer,  $z_i$  :

$$z_i = \sqrt{[(i-1)/N] \cdot H}$$

where N is defined as  $(T_{\text{max}} / P_{\text{des}})$ . A consequence of the above is that if N layers of reinforcement are required, then (N + 1) will be provided, because an extra layer is automatically placed at the base (see Table 3.2). It was assumed in the example above that this basal layer of reinforcement was to be ignored for mechanisms which slide across its upper surface. If the slope is of "wrap-around" construction (see Appendix E) or has any other facing, then this basal layer of reinforcement may be taken into account (provided that the strength of the facing is adequate). In the case of geosynthetics with a "wrap-round" front face, however, the reinforcement force should be assumed to act tangentially to the material at the point at which the assumed failure mechanism cuts it (Figure F.2). The full strength of the underlying geosynthetic layer acting horizontally may only be included for mechanisms which outcrop at the very bottom of the interval above it.

F.6 The case for inclined reinforcement (ie. soil nailing) is no different from that for horizontal reinforcement in this respect. It will be seen that the same rulings for optimum layer spacings apply, assuming that nail capacities (per metre width of wall) are again uniform with depth. The latter implies a constant horizontal spacing,  $S_h$ . Alternatively a constant vertical nail spacing could be adopted with a reducing horizontal spacing,  $S_h$ , or increasing nail capacity with depth, such that the parabolic reinforcement requirement of Figure F.1a is met.

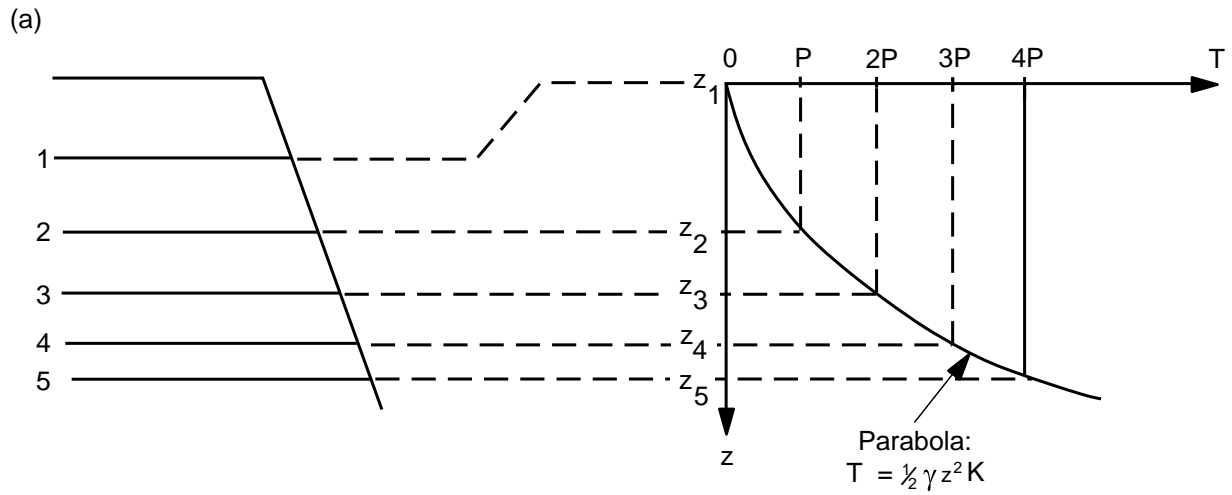

Note:  $(1 \times P) = \frac{1}{2} \gamma z_2^2 K$   
 $(2 \times P) = \frac{1}{2} \gamma z_3^2 K$  etc

where:  $K = T_{\max} / \frac{1}{2} \gamma H^2$

Since  $T_{\max} = N \times P$

then:  $z_2 = \sqrt{\frac{1}{N} \times H}$

or:  $z_i = \sqrt{\frac{(i-1)}{N} \times H}$

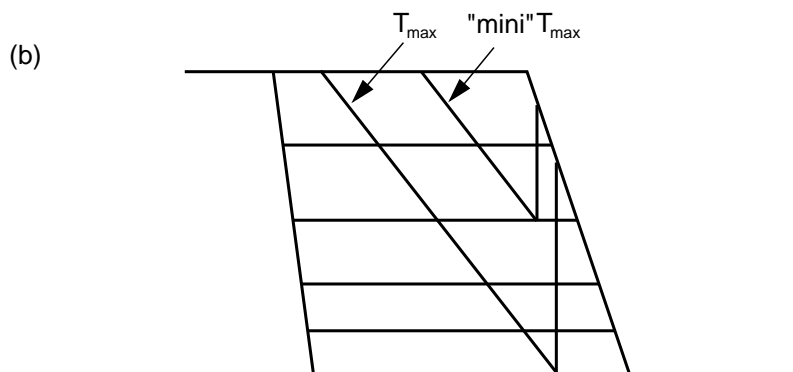

Figure F.1 Optimum layer spacings

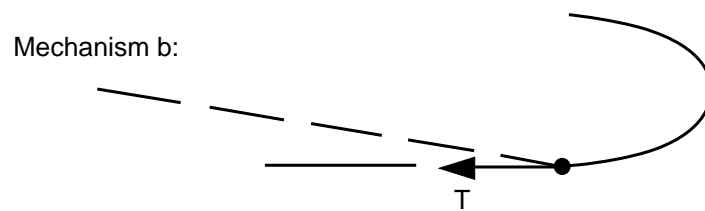
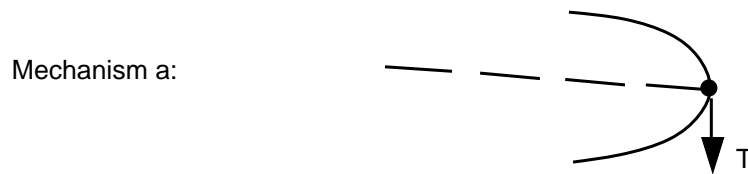
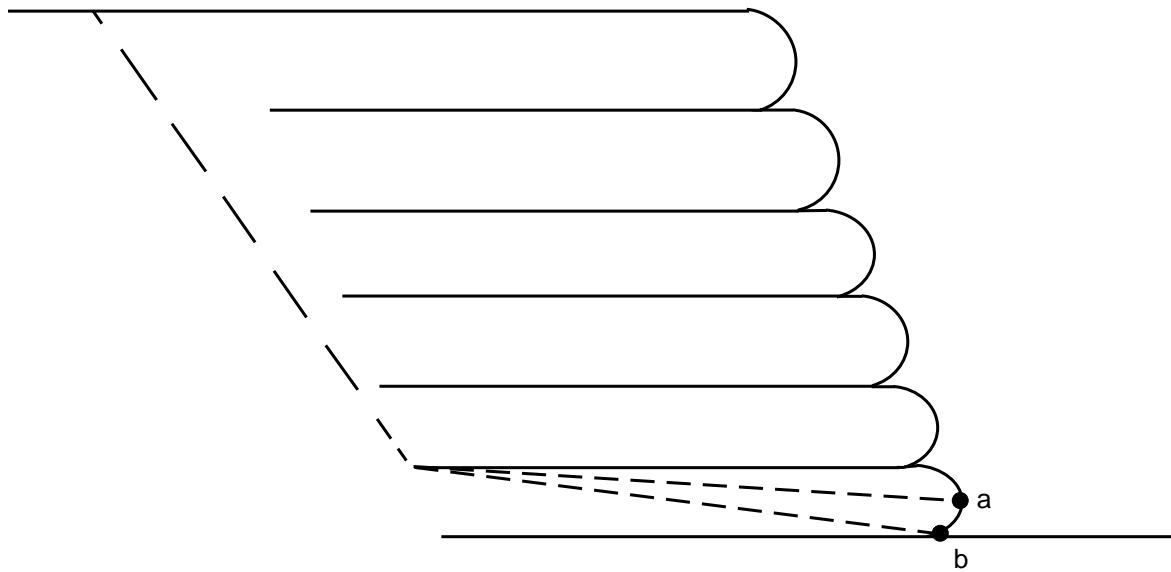

Figure F.2 Direction of reinforcement force on "wrap around" detail

## CHECKING OTHER INTERNAL MECHANISMS

- G.1 In most cases, if the basic procedure described in this Advice Note (paragraphs 3.16 to 3.18 or paragraphs 4.16 to 4.22) is followed it is likely that all possible intermediate mechanisms will be automatically catered for, if the foundation material is competent (if not, then see Appendix B). Intermediate mechanisms such as those shown in Figure G.1 should, however, be checked to confirm this. The family of mechanisms which extend from the heel of the  $T_{\max}$  mechanism, B, to the back of the upper layers of reinforcement,  $A_1$ ,  $A_2$  etc have special significance. These mechanisms shown in Figure G.1, are referred to as the " $T_{\max-1}$ " and " $T_{\max-2}$ " mechanisms respectively, since they correspond to the first and second layers (and so on) of reinforcement. This family of mechanisms can be more critical than the  $T_{\max}$  mechanism itself. Although the  $T_{\max-1}$  mechanism requires less reinforcement force than the  $T_{\max}$  mechanism (by definition), it has even less *available* force. The  $T_{\max-1}$ ,  $T_{\max-2}$  etc family of mechanisms may usually be satisfied by the provision of an extra layer of reinforcement. This is why the optimum layer depths given in Table 3.2 provide  $(N + 1)$  layers instead of  $N$ . An exception to this rule is the case where no wrap-round or structural facing is provided. Here the provision of the extra layer of reinforcement at the base of the slope does not contribute, since the mechanism forms above it. In this case an appropriate extension to  $L_T$  may be required.
- G.2 The inclined basal mechanism' X , Figure G.1 , should also be checked and  $L_B$  may need to be extended as a result. This is unlikely to be the case, however, unless there is no front facing or wrap-round and a particularly high value for  $\lambda_s$  has been adopted (ie.  $\lambda_s \approx 0.9$  or greater).

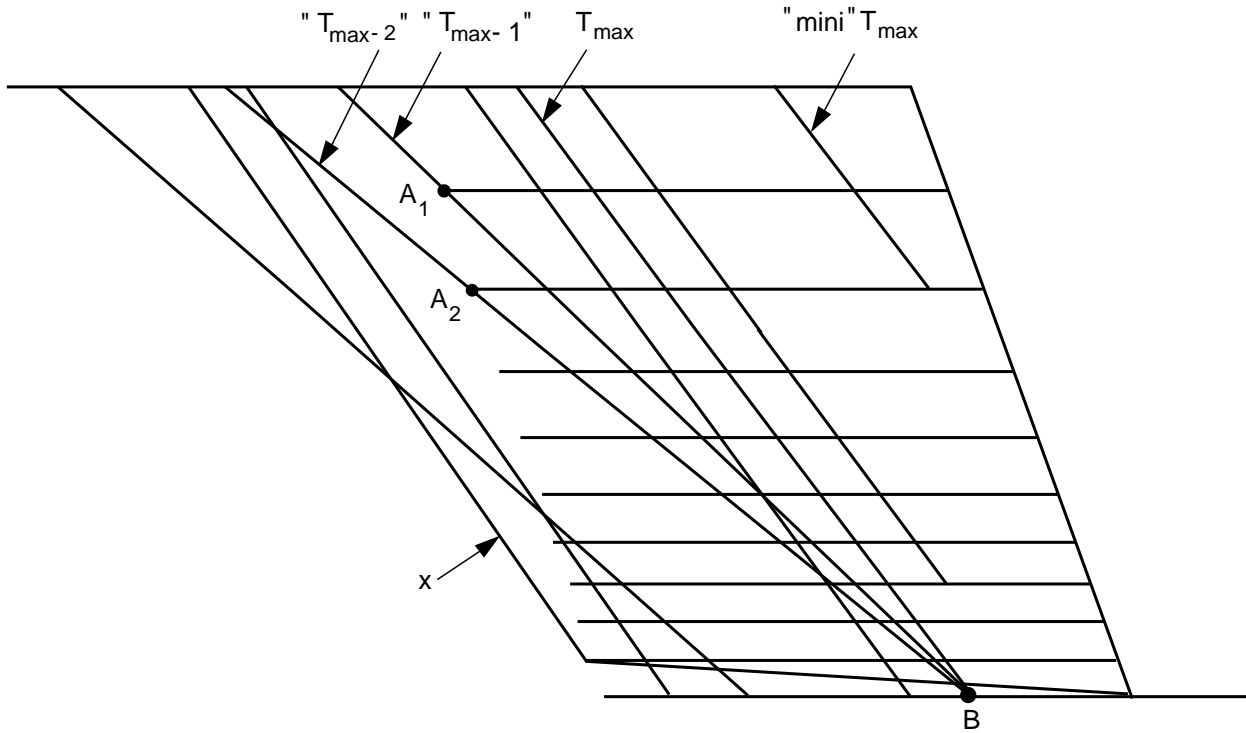

Figure G.1 Intermediate two-part wedge mechanisms

# HYBRID CONSTRUCTION

- H.1 This appendix addresses the special case of hybrid construction where an existing embankment slope is to be stabilised by inclined soil nailing before building onto it a new reinforced soil extension (Embankment Type 2, Figure 3.1), or where a slip has occurred and the slope is to be reinstated by a combination of inclined soil nailing of the existing ground and replacement of the slipped soil and horizontal soil reinforcement (Embankment Type 3, Figure 3.1).
- H.2 In the simplest case (described in the main text) where the spacing, strength and pull-out characteristics of the soil nails are the same or superior to the layers of horizontal soil reinforcement and the soil nails are installed approximately horizontally, then the two types of reinforcement will be equivalent and both will be governed by the same  $L_T$ ,  $L_B$  (calculated using the most critical of the two fill soil strength parameters in each case) as per the basic procedure from paragraphs 3.19 to 3.23. However, in practice, this equivalence is unlikely to be achieved in all respects. The vertical spacing and strength of the nails may be matched easily enough to those of the soil reinforcement, but the nails are likely to be *inclined* and their pull-out resistance per metre length ( $P_{des}/L_e$ , paragraph 2.23) is likely to be *inferior*.
- H.3 The effect of the inclination of the soil nails will mean that the required nail force to be provided should be *greater* than the horizontal soil reinforcement force by the factor,  $\zeta$ , given in equation 2 (paragraph 4.3):

$$\begin{aligned} \text{Required } (P_{des})_{nail} &= [\cos(\theta-\phi') / \cos(\theta-\phi'+\delta)]. (P_{des})_{horiz} \\ &= \zeta \cdot (P_{des})_{horiz} \end{aligned}$$

where  $\phi'$  = angle of friction of weakest fill  
 $\delta$  = inclination of soil nail to the horizontal  
 $\theta$  = angle of failure mechanism which cuts soil nail  
 $\zeta$  =  $[\cos(\theta-\phi') / \cos(\theta-\phi'+\delta)]$

- H.4 The effect of the inferior pull-out resistance of the nails is that nail lengths will need to be extended beyond the zone defined by  $L_T$ ,  $L_B$  for horizontal reinforcement. Hence the following revised design steps are recommended:
- i. Calculate the reinforcement requirement assuming that the whole slope is to be constructed with horizontal reinforcement using the basic procedure given in paragraphs 3.16 to 3.18 and using the most critical of the two fill strength parameters. Draw up the slope section with the layers of horizontal reinforcement and erase all the reinforcement below the existing slope (Figure H.1a).
  - ii. Set  $d_{bar}$  and  $S_h$  from  $(P_{des})_{nail} = \zeta \cdot (P_{des})_{horiz}$ . (Calculate  $\zeta$  using  $\theta = \theta_1$  from  $T_{max}$  mechanism).
  - iii. Calculate  $(L_e)_{nail}$  for first nail layer required, and draw it on the diagram, starting from the line of the existing slope (Figure H.1b), where:

$$(L_e)_{nail} = \frac{(P_{des})_{nail} \cdot S_h}{\pi d_{hole} \alpha_{nail} [\sigma'_n \tan \phi'_{des} + c'_{des}]}$$

This then defines point A.

- iv. Extend line of  $L_T$ ,  $L_B$  to bottom nail (Figure H.1c). This then defines point B.
- v. Draw in other nail layers to the boundary AB (Figure H.1d).

**Appendix H**

---

- vi. Check other potential internal two-part wedge failure mechanisms (eg Figure H.1e).
- H.5 In some cases the assumption of a single value of  $\phi'_{des}$  throughout the slope corresponding to the worst of the two fill types, and the requirement for the full nail pull-out length in step iii above may be too onerous. It is recommended that these measures are adopted in order to provide a preliminary design, then trimming of the preliminary design may be undertaken if it can be demonstrated to be justifiable.
- H.6 In practice, it is likely that a series of benches will be cut into the existing ground, before filling is commenced. This applies to both embankment Types 2 and 3 (Figure 3.1). For this case, the same simple rules given above should still apply. An example is shown in Figure H.2.



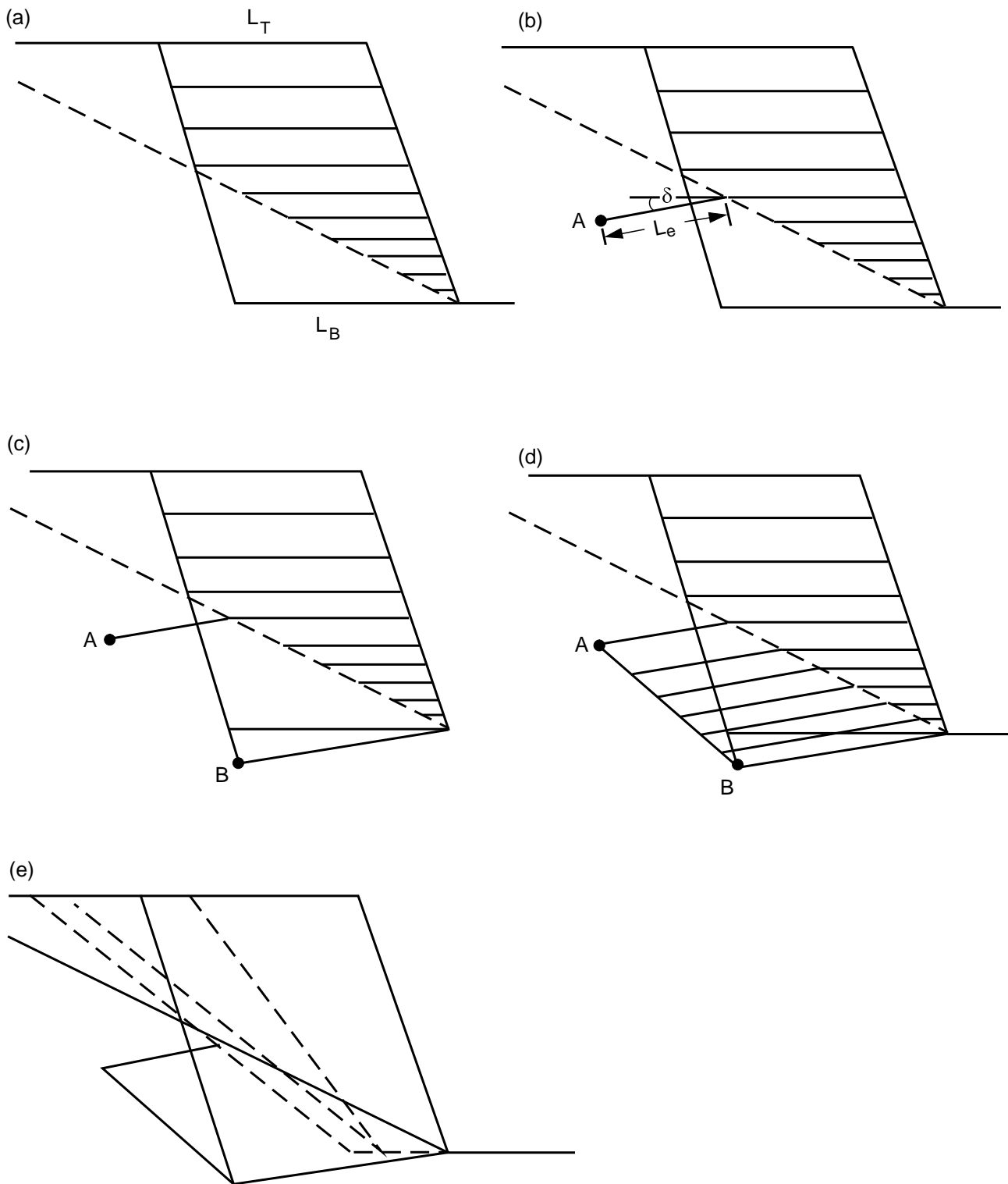

Figure H.1 Design steps for hybrid

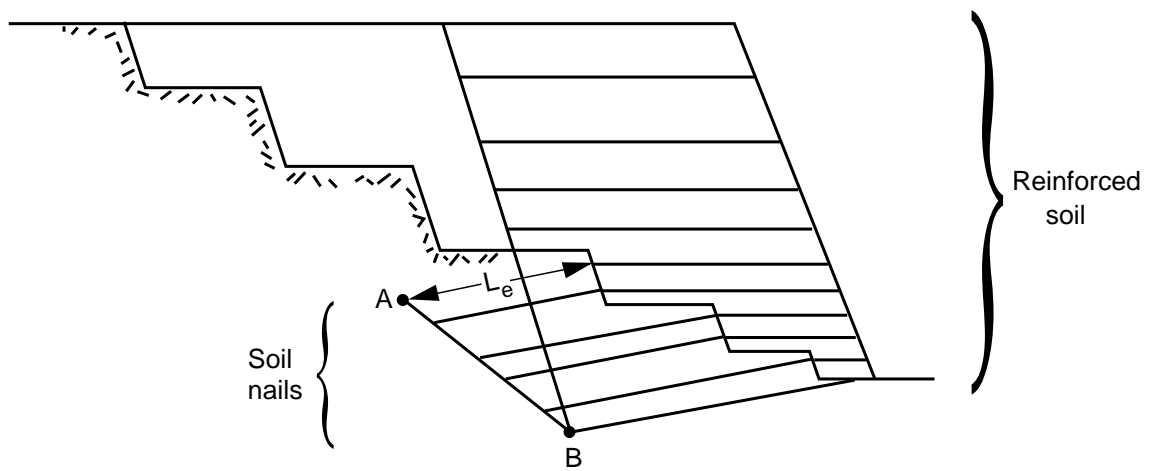

Figure H.2 Hybrid construction with benching

# MODIFICATIONS TO BASIC SOIL NAILING DESIGN METHOD

## Over-conservatism

- I.1 The design approach for soil nailing described in this Advice Note is known to be inherently conservative, and has the advantage of being directly compatible with the design approach described for reinforced soil. The main source of conservatism lies in the assumption that the total nail force is applied directly to the upper of the two wedges only (Wedge 1) in the two-part wedge mechanism. A consequence of the above assumption is that shallow angles of  $\delta$  will tend to be favoured, in order to minimise the value of  $T_{\max\delta}$ .
- I.2 As shown in Figure I.1, the actual nail force allocation between the two wedges is governed by the position of the inter-wedge boundary. The correct allocation should be for all nails below point A to be assigned to Wedge 2 (assuming that the nails all have adequate front face plates, or are tied into a structural facing) and all those above A to Wedge 1. The designer may base his design on this approach if desired. However, as previously discussed, an iterative solution technique will be required to solve the general equation given in Appendix A.

## Compatibility with Other Methods

- I.3 It will be noted that when the design method for soil nailing advocated in this Advice Note is applied, a nailing layout of decreasing nail length and nail spacing with depth such as that shown in Figure I.2a is obtained. Other design approaches may provide constant nail length and spacing with depth, such as that shown in Figure I.2b. Design layouts of the kind shown in Figure I.2b will only be acceptable if they can be shown to satisfy the following requirements (or the equivalent):
- i. The layout must contain sufficient total reinforcement force to satisfy the  $T_{\max\delta}$  mechanism ( $\phi'_{12} \leq 0.5 \phi'_{\text{des}}$ ).
  - ii. The layout must extend sufficiently far back to contain the  $T_{o\delta}$  mechanism ( $\phi'_{12} \leq 0.5 \phi'_{\text{des}}$ ).
  - iii. All intermediate mechanisms must be sufficiently catered for.
  - iv. The vertical spacing between layers should not be such as to cause local overstressing in the reinforcement at any level.
- I.4 The method of calculating soil nail pull-out lengths in this Advice Note may be waived in favour of empirically derived pull-out lengths, provided that these are confirmed on site by trials conducted under realistic and well-understood boundary conditions and slowly enough for excess pore water pressures to be negligible.

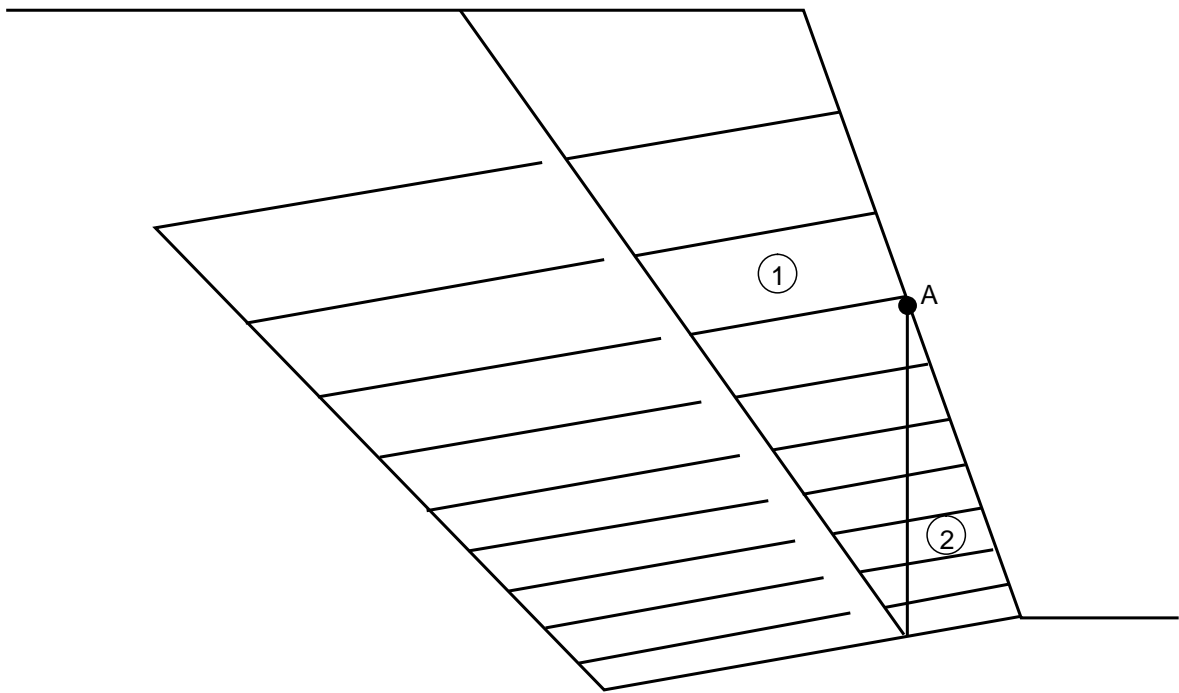

Figure I .1 Two-part wedge with soil nails

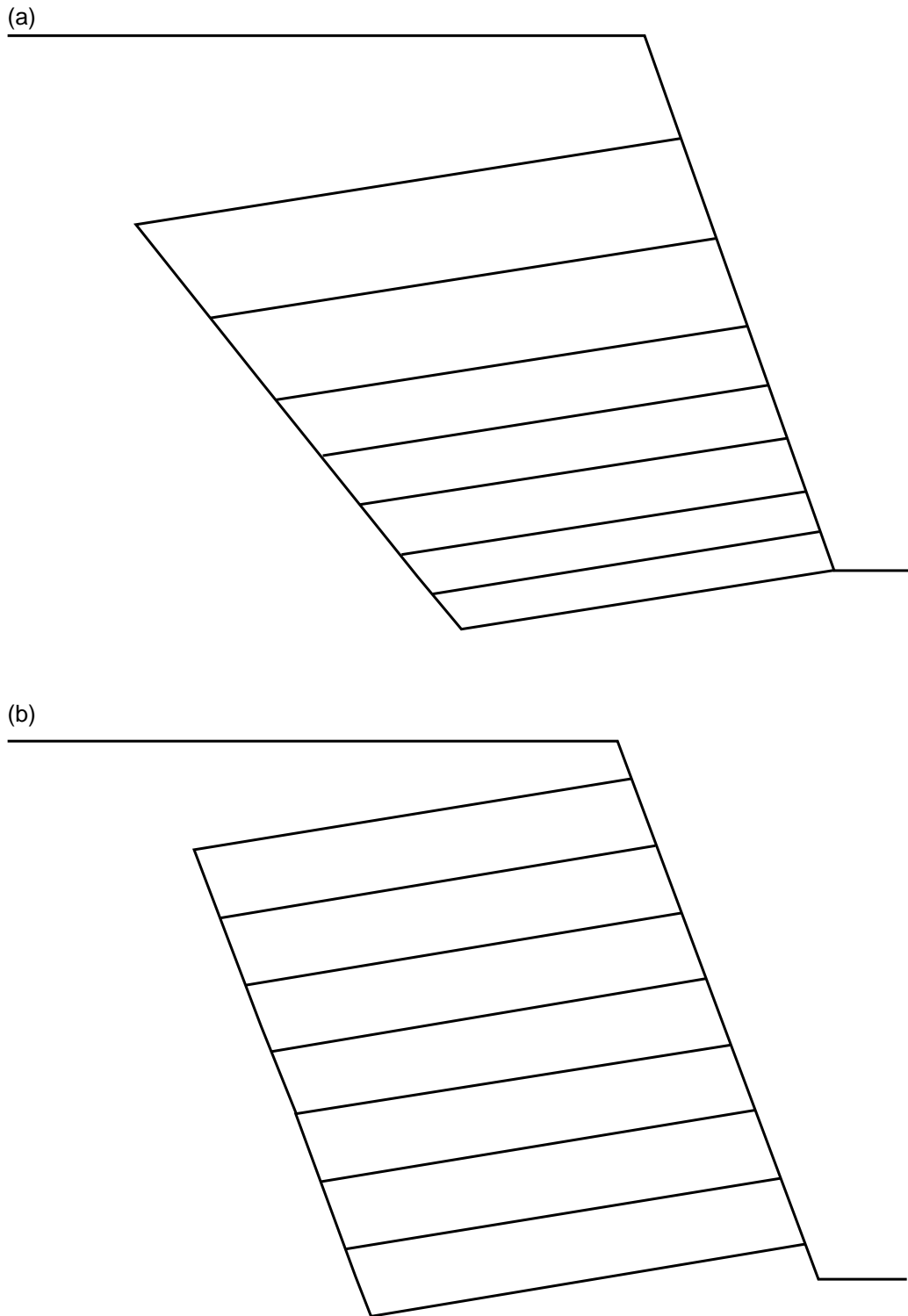
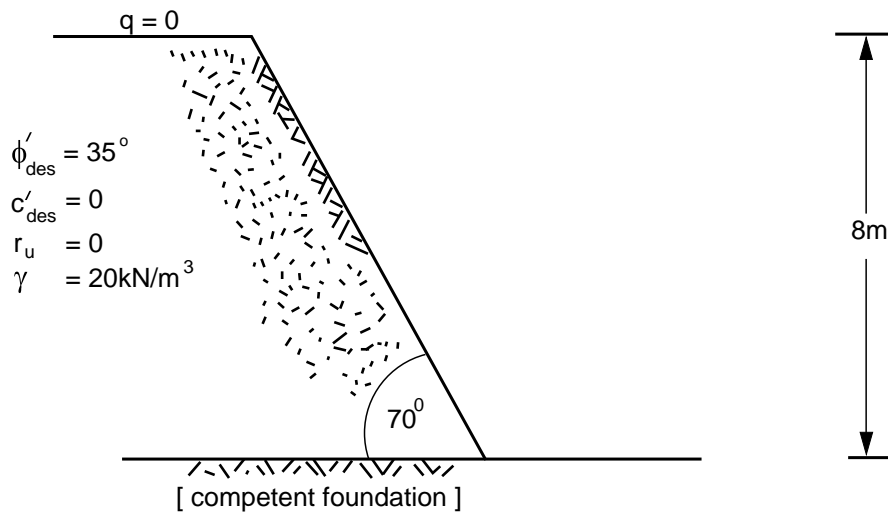

Figure I .2 Alternative soil nailing layouts

# WORKED EXAMPLES

Example 1: (Type 1 Embankment)



1.  $T_{max} = 113\text{ kN/m}$   
 $X = 1.3\text{m}$   
 $Y = 0$   
 $\theta_1 = 58^\circ$  ( from Table 3.1 )  
 $T_{ob} : L_B = 3.4\text{m}$  ( from Table 3.1, based on  $\lambda_s = 0.8$  )
2.  $P_c = 20\text{ kN/m}$   
 $f_d = 1.1$   
 $f_e = 1.1$   
 $f_m = 1.15$  } say

$$\Rightarrow P_{des} = 14.4\text{ kN/m}$$

$$\Rightarrow N = 113 / 14.4 = 7.8, \text{ say } 8$$

$$\Rightarrow Z_1 = \frac{1}{2} H / \sqrt{N}$$

$$= 1.4\text{m}$$

$$\Rightarrow L_{e1} = \frac{P_{des}}{2 \alpha' \sigma'_v \tan \phi'_{des}}$$

$$= \frac{14.4}{2 \times 0.95 \times (20 \times 1.4) \times \tan 35^\circ}$$

$$= 0.4\text{ m}$$

Appendix J

3. Layer Depths: ( from Table 3.2 )

| Layer | $H \sqrt{\left[ \frac{i-1}{N} \right]}$ |
|-------|---|
| 1     | 1.4                                     |
| 2     | 2.8                                     |
| 3     | 4.0                                     |
| 4     | 4.9                                     |
| 5     | 5.7                                     |
| 6     | 6.3                                     |
| 7     | 6.9                                     |
| 8     | 7.5                                     |
| 9     | 8.0                                     |

( Note: See Diagram 1 for reinforcement layout )

Diagram 1

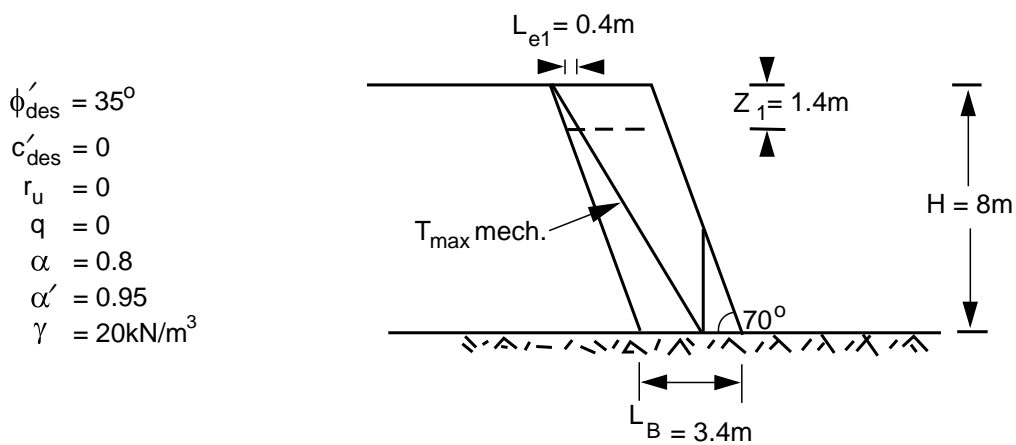

= > Preliminary reinforcement layout:

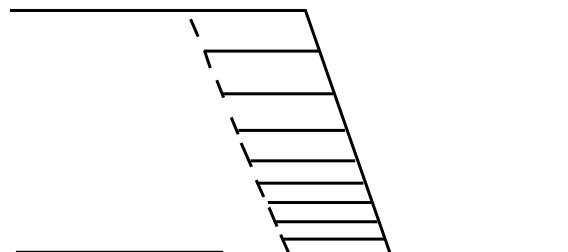

Example 2: (Type 1 Embankment)

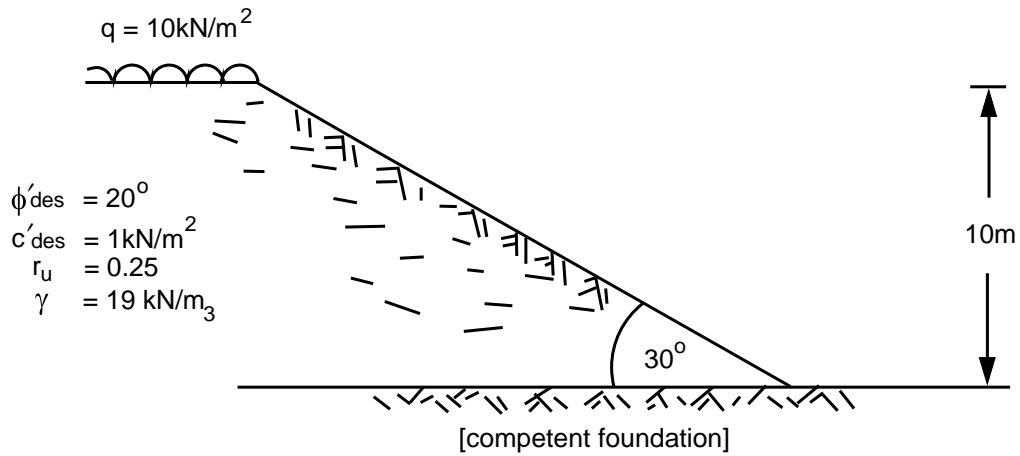

Reinforcement: horizontal geotextile  
( $\alpha = 0.85$ )

$$1. \quad \begin{array}{l} T_{\max} = 298 \text{ kN/m} \\ X = 13.2\text{m} \\ Y = 0 \\ \theta_1 = 46^\circ \end{array} \quad \left( \begin{array}{l} \text{for } H' = H + q/\gamma \\ = 10.5\text{m} \end{array} \right)$$

$$T_{ob}: \quad L_B = 22.4\text{m} \quad (\text{based on } \lambda_s = 0.85)$$

$$2. \quad \left. \begin{array}{l} P_c = 40 \text{ kN/m} \\ f_d = 1.05 \\ f_e = 1.1 \\ f_m = 1.2 \end{array} \right\} \text{ say}$$

$$\Rightarrow P_{des} = 28.9 \text{ kN/m}$$

$$\Rightarrow N = 298 / 28.9 = 10.3, \text{ say } 11.$$

$$\Rightarrow Z_1 = \frac{1}{2} H' / \sqrt{N}$$

$$= 1.6\text{m}$$

$$\Rightarrow L_{e1} = \frac{P_{des}}{2 \alpha (\sigma'_v \tan \phi'_{des} + c'_{des})}$$

$$= \frac{28.9}{2 \times 0.85 \times ([1.6 \times 19 \tan 20^\circ] [1 - 0.25] + 1)}$$

$$= 1.8 \text{ m}$$



Appendix J

| 3.Layer | $H' \sqrt{\left[ \frac{i-1}{N} \right]}$ | ( from Table 3.2 ) |
|---------|--|--------------------|
| 1       | 1.6 - 0.5 = 1.1                          |                    |
| 2       | 3.2 - 0.5 = 2.7                          |                    |
| 3       | 4.5 - 0.5 = 4.0                          |                    |
| 4       | 5.5 - 0.5 = 5.0                          |                    |
| 5       | 6.3 - 0.5 = 5.8                          |                    |
| 6       | 7.1 - 0.5 = 6.6                          |                    |
| 7       | 7.8 - 0.5 = 7.3                          |                    |
| 8       | 8.4 - 0.5 = 7.9                          |                    |
| 9       | 9.0 - 0.5 = 8.5                          |                    |
| 10      | 9.5 - 0.5 = 9.0                          |                    |
| 11      | 10.0 - 0.5 = 9.5                         |                    |
| 12      | 10.5 - 0.5 = 10.0                        |                    |

Diagram 2

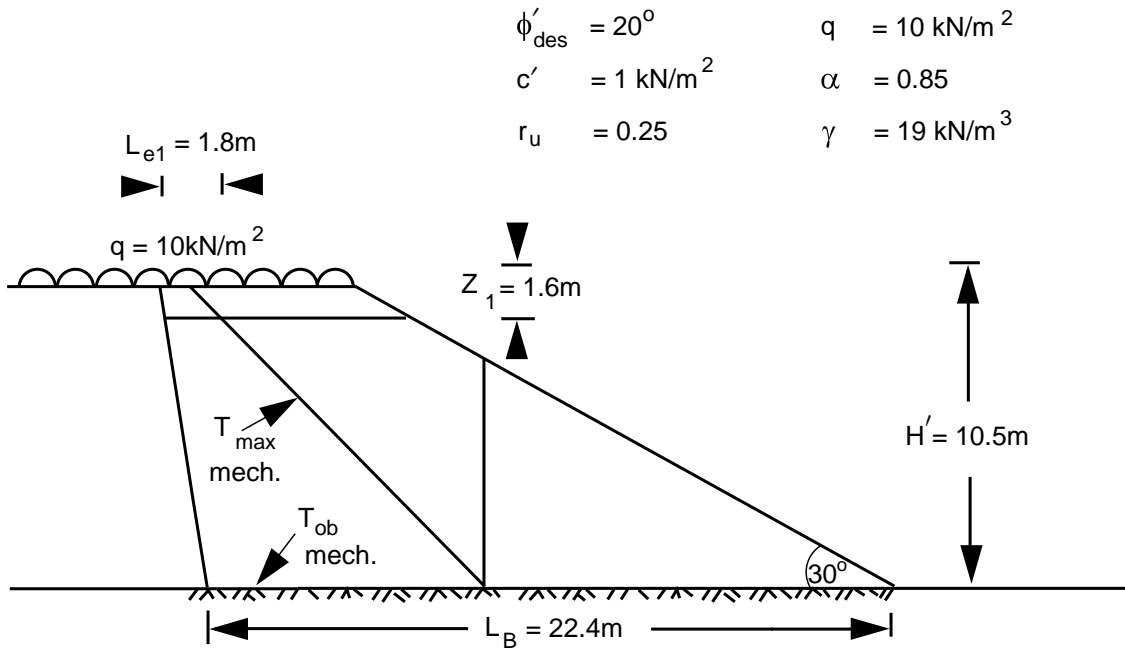

= > Preliminary reinforcement layout:

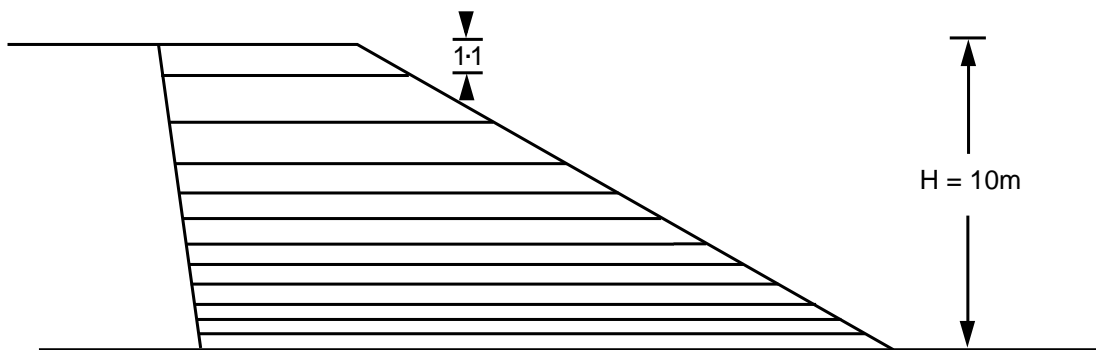

Example 3: (Type 1 Cutting)

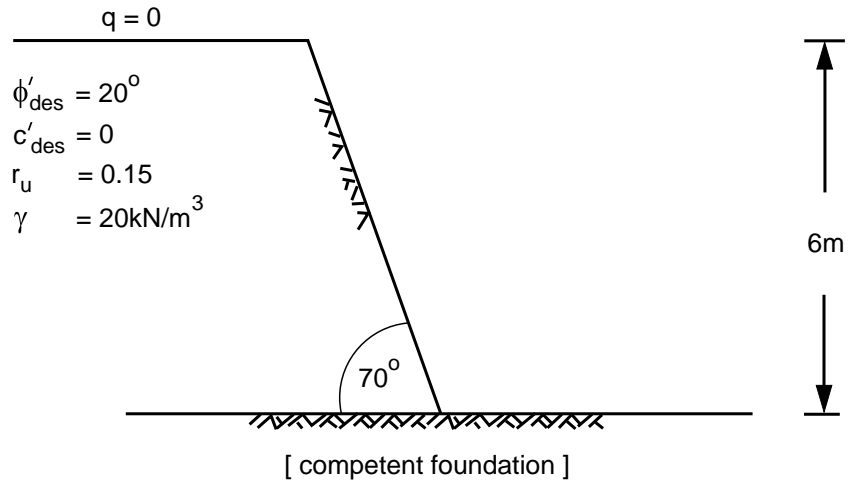

Reinforcement: Soil nails inclined at  $10^\circ$   
( $\alpha = 0.9$ )

$$\begin{aligned}
 1. \quad T_{\max\phi} &= 207 \text{ kN/m} \\
 X &= 16 \text{ mm} \\
 Y &= -X \tan \delta \\
 \theta_1 &= 59^\circ
 \end{aligned}$$

$$T_{ob}: \quad L_B = 5.1 \text{ m} \quad (\lambda_s = 1)$$

$$2. \quad P_{des} = \sigma_y \frac{\pi}{4} d_{bar}^2 / f_d \cdot f_e \cdot f_m \cdot S_h$$

$$\left. \begin{aligned}
 \text{Where } \sigma_y &= 275 \text{ N/mm} \\
 d_{bar} &= 16 \text{ mm} \\
 S_h &= 1.0 \text{ m} \\
 f_d &= 1.05 \\
 f_e &= 1.2 \\
 f_m &= 1.05
 \end{aligned} \right\} \text{ say}$$

$$\Rightarrow P_{des} = 41.8 \text{ kN/m}$$

$$\Rightarrow N = 207 / 41.8 = 5.0$$

$$\Rightarrow Z_1 = 0.5 H / \sqrt{N}$$

$$= 1.3m$$

$$\Rightarrow L_{e1} = \frac{P_{des} \cdot S_h}{\Pi d_{hole} \alpha \sigma'_n \tan \phi'_{des}}$$

where  $d_{hole} = 0.15m$

$$\sigma'_n = \frac{1}{4} (3 + K_a) \sigma'_v \quad (\text{ AppendixD } )$$

$$K_a = 0.49$$

$$\sigma'_v = \gamma z_{av} (1 - r_u)$$

$$\Rightarrow \sigma'_n = 14.9 z_{av}$$

$$\Rightarrow L_{e1} = 18.3 / z_{av} \quad \text{guess } z_{1av} \approx 2.4m$$

$L_{e1}$  excessive, hence try  $L_{e2}$

$$, z_2 = H / \sqrt{N}$$

$$= 2.7m \quad \text{guess } z_{2av} \approx 3.5m$$

$$\Rightarrow L_{e2} = 18.3 / 3.5$$

$$= 5.2m$$

Horizontal spacing on first layer will need to be reduced from 1.0m to

$$\frac{L'_{e1}}{L_{e1}} \times 1m = \frac{5.8}{7.5} = 0.77m, \text{ say } 0.75m$$

( Note: See Diagram 3 for preliminary nail layout )



Example 4: Embankment Type 2 (Hybrid)

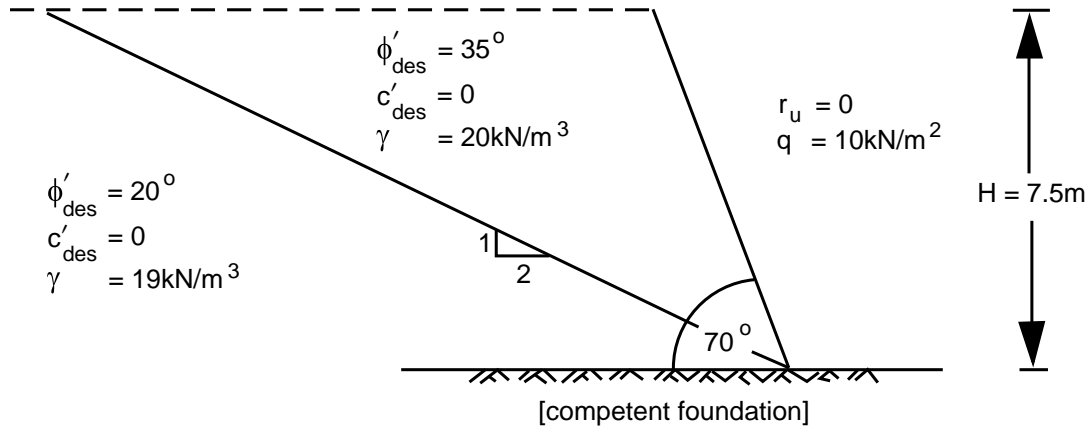

Geogrid reinforcement ( $\alpha = 0.8, \alpha' = 0.95$ )  
+ Soil nails ( $\alpha = 0.9$ ) inclined at  $10^\circ$ .

1. Geogrid requirements:

$$\left. \begin{array}{l} T_{\max} = 266 \text{ kN/m} \\ X = 2.0 \\ Y = 0 \\ \theta_1 = 53^\circ \\ L_B = 8.2 \text{ ( based on } \lambda_s = 0.8 \text{ )} \end{array} \right\} \text{ Table 3.1 for } \phi'_{des} = 20^\circ, H' = 8\text{m}, \gamma = 20 \text{ kN/m}^3$$

$$P_{des} = 27 \text{ kN/m, say}$$

$$\Rightarrow N = 266 / 27 \\ = 9.9, \text{ say } 10$$

$$\Rightarrow Z_1 = \frac{1}{2} H' / \sqrt{N} \\ = \frac{1}{2} \times 8 / \sqrt{10} = 1.26\text{m}$$

$$\Rightarrow L_{e1} = 27/2 \times 0.95 \times (20 \times 1.26) \times \tan 20^\circ \\ = 1.6\text{m}$$

See diagram 4 for other layer depths, as per Table 3.2.

2. Calculate  $\zeta$ :

$$\begin{aligned}\zeta &= \cos(53 - 20) / \cos(53 - 20 + 10) \\ &= 1.15\end{aligned}$$

$$\begin{aligned}\Rightarrow (P_{des})_{nail} &= 1.15 (P_{des})_{geogrid} \\ &= 31 \text{ kN/m}\end{aligned}$$

$$S_h = \sigma_y \frac{\pi}{4} d_{bar}^2 / f_d f_e f_m (P_{des})_{nail}$$

$$\begin{aligned}\text{Say } d_{bar} &= 16\text{mm} \\ \sigma_y &= 265 \text{ N/mm}^2 \\ f_d &= 1.1 \\ f_e &= 1.3 \\ f_m &= 1.1\end{aligned}$$

$$\Rightarrow S_h = 1.1\text{m}$$

$$3. (L_e)_{nail} = \frac{(P_{des})_{nail} \cdot S_h}{\pi d_{hole} \alpha_{nail} \sigma'_n \tan \phi'_{des}}$$

$$\begin{aligned}\text{where } d_{hole} &= 0.15\text{m} \\ \sigma'_n &= 1/4 (3 + K_a) \sigma'_v \\ K_a &= 0.49 \\ \sigma'_v &= \gamma z_{av} \\ \Rightarrow \sigma'_n &= 16.6 z_{av} \\ \Rightarrow (L_e)_{nail} &= 13.3 / z_{av} && \text{guess } z_{av} \approx 4.6\text{m} \\ &= 2.9\text{m}\end{aligned}$$

( Note : See Diagram 4 for reinforcement layout )

Diagram 4: (Hybrid)

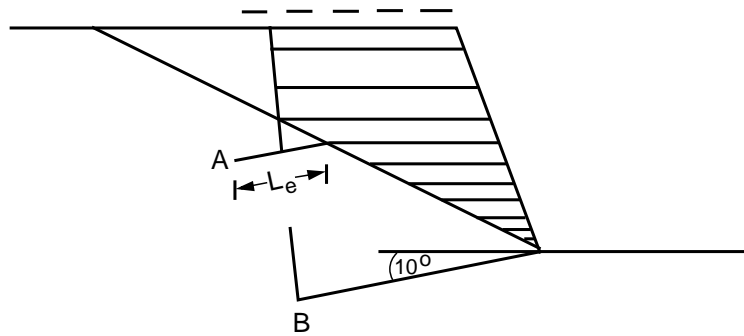
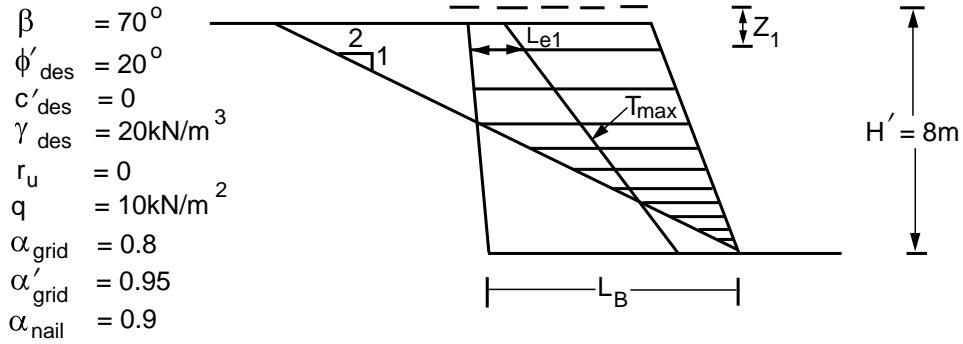

Preliminary layout:

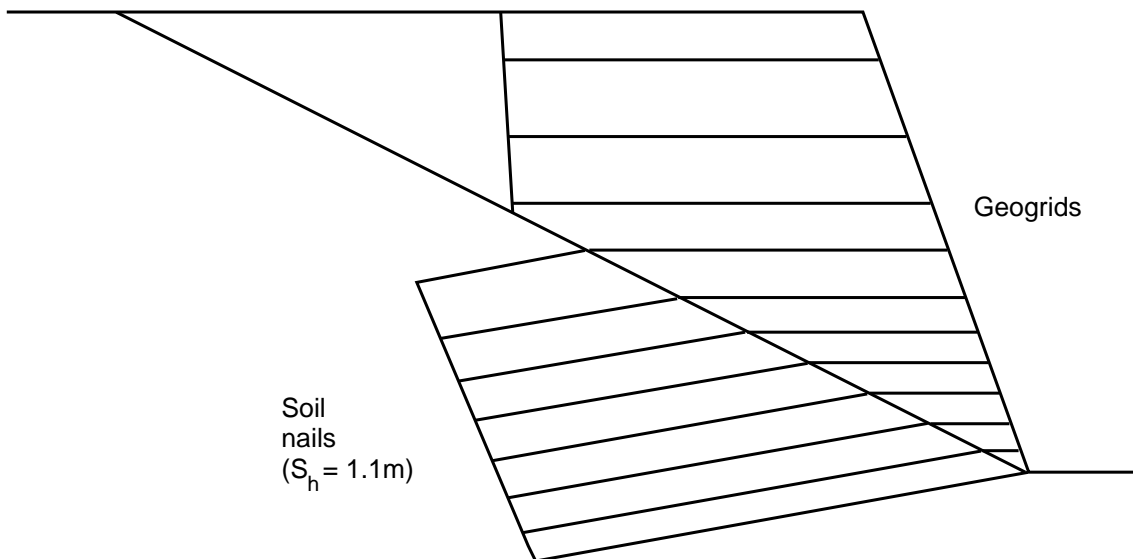

Example 5: Type 3 Embankment (Slip Repair)

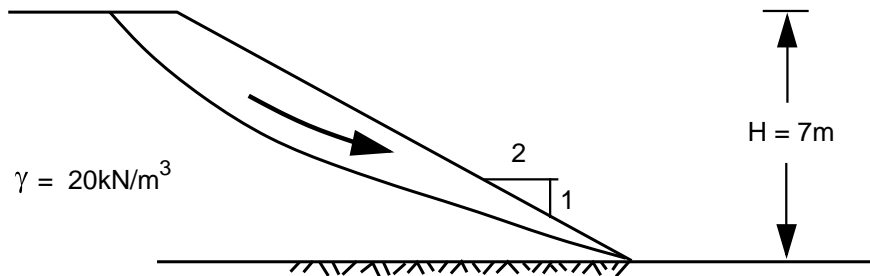

A slip has occurred in a stiff clay embankment and the geometry of the slip is well approximated by the following two-part wedge ( see Diagram 5 )

$$\begin{aligned} X &= 11\text{m} \\ Y &= 3.8\text{ m} \\ \theta_1 &= 35^\circ \end{aligned}$$

1. By trial and error, it is quickly found that values of  $\phi'$ ,  $c'$  which would provide a factor of safety of unity on the above geometry are (assuming  $r_u = 0$ ):

$$\begin{aligned} \phi' &= 20^\circ \\ c' &= 1.5\text{ kN/m}^2 \end{aligned}$$

$$2. \Rightarrow \phi'_{\text{des}} = \tan^{-1} \left( \frac{\tan 20^\circ}{1.1} \right) = 18.3^\circ$$

$$c'_{\text{des}} = 0 \quad (\text{conservative})$$

3. Repair of the slope is to be carried out by excavation, followed by replacement of the slipped material reinforced with layers of geotextile ( $\alpha = 0.8$ )

$$\begin{aligned} 4. \quad T_{\text{max}} &= 77\text{ kN/m} \\ X &= 8.7 \\ Y &= 0 \\ \theta &= 42 \\ L_B &= 14.0 \quad (\lambda_s = 0.8) \end{aligned}$$



Appendix J

$$5. \quad \left. \begin{array}{l} P_c = 21 \text{ kN/m} \\ f_d = 1.1 \\ f_e = 1.1 \\ f_m = 1.1 \end{array} \right\} \text{ say}$$

$$\Rightarrow P_{des} = 15.8 \text{ kN/m}$$

$$\Rightarrow N = 77 / 15 = 4.9, \text{ say } 5.$$

$$\Rightarrow Z_1 = \frac{1}{2} H / \sqrt{N}$$

$$= 1.57 \text{ m}$$

$$\Rightarrow L_{e1} = \frac{P_{des}}{2 \alpha \sigma'_v \tan \phi'_{des}}$$

$$= \frac{15.8}{2 \times 0.8 \times (20 \times 1.57) \times \tan 18.3}$$

$$= 1.0 \text{ m}$$

6. Layer Depths

|   |     |
|---|-----|
| 1 | 1.6 |
| 2 | 3.1 |
| 3 | 4.4 |
| 4 | 5.4 |
| 5 | 6.3 |
| 6 | 7.0 |

Note: The repair could also have been attempted by using a soil nailing/reinforced soil hybrid design.

Diagram 5: (Slip repair)

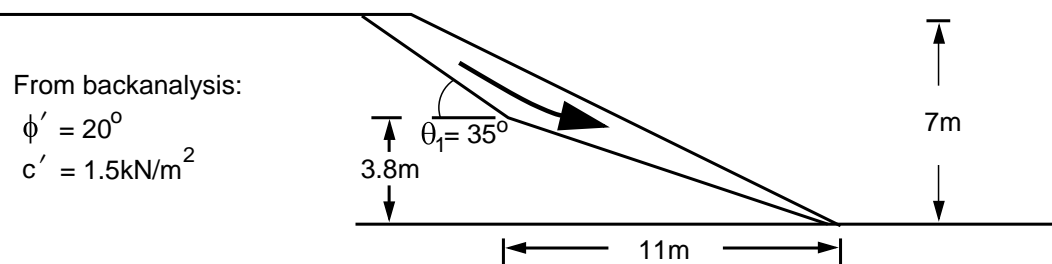

Preliminary reinforcement layout with geotextile:

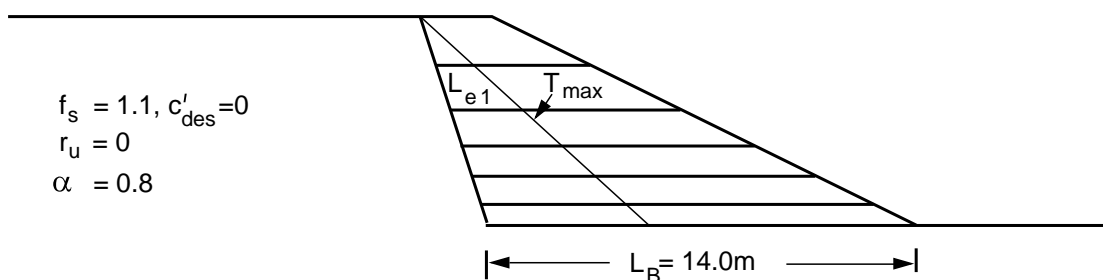

Example 6: (Type 2 cutting) with "unstable2 upper slope

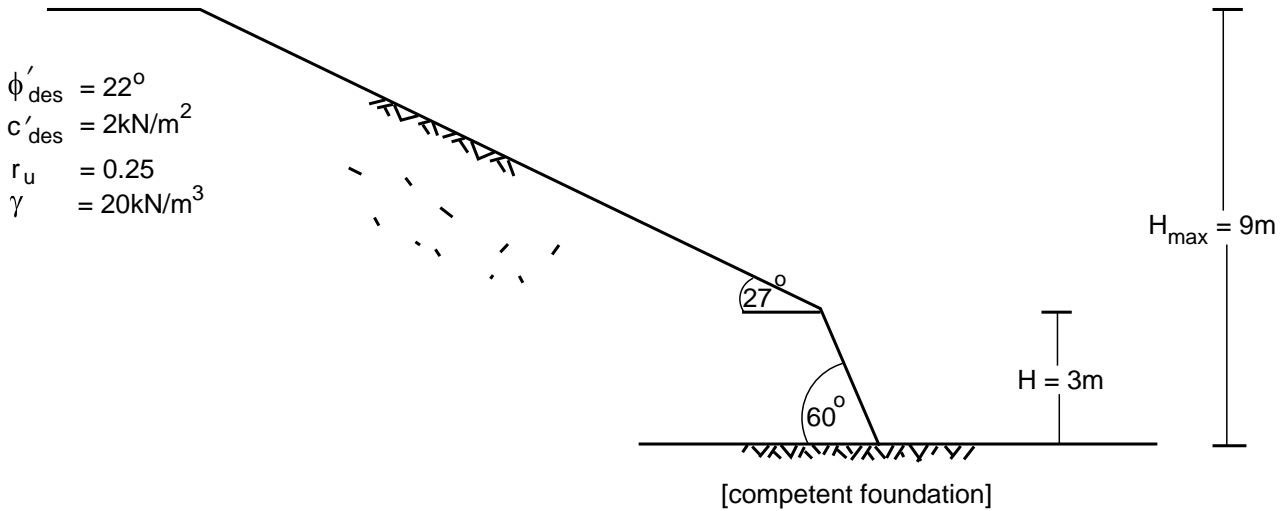

Reinforcement: soil nails inclined at  $10^\circ$  ( $\alpha = 0.8$ )

Lower Slope

1. For  $H = 3\text{m}$ ,  $H_{max} = 9\text{m}$ ,  $i = 27^\circ$ ,  $\beta = 60^\circ$ :

$$\begin{aligned}
 T_{max} &= 160 \text{ kN/m} \\
 X &= 8.0 \\
 Y &= 0.8 \\
 \theta_1 &= 45^\circ \\
 L_B &= 10.7\text{m} \quad (\lambda_s \approx 1)
 \end{aligned}$$

2. Say  $P_{des} = 41.8 \text{ kN/m}$  (from Example 3)

$$\Rightarrow N = 160 / 41.8 = 3.8, \text{ say } 4$$

$$\Rightarrow Z_1 = \frac{1}{2} H / \sqrt{N} = 0.75\text{m}$$

Appendix J

$$L_{e1} = P_{des} \cdot S_h / \pi d_{hole} \alpha ( \sigma'_n \tan \phi'_{des} + c'_n )$$

where

$$\begin{aligned} P_{des} &= 41.8 \text{ kN/m} \\ S_h &= 1\text{m} \\ d_{hole} &= 0.15\text{m, say} \\ \alpha &= 0.8 \\ \sigma'_n &= 1/4 ( 3 + K_a ) \sigma'_v \\ K_a &= 0.45 \end{aligned}$$

$$\Rightarrow \sigma'_n = 0.86 \sigma'_v = 0.86 \gamma z_{av} [ 1 - r_u ] \quad \text{guess } z_{1av} \approx 6.3\text{m}$$

$$\Rightarrow L_{e1} = 3.2\text{m}$$

3. Layer spacings taken from Table 3.2, as shown on Diagram 6.

Upper Slope

1. For  $H = 6\text{m}$ ,  $\beta = 27^\circ$  :

$$\begin{aligned} T_{max} &= 37.0 \text{ kN/m} \\ X &= 6.6 \\ Y &= -0.2\text{m} \\ \theta_1 &= 40^\circ \\ L_B &= 8.4\text{m} \end{aligned}$$

2. Say
- $$\begin{aligned} S_h &= 2\text{m} \\ \Rightarrow P_{des} &= 20.9 \text{ kN/m} \\ \Rightarrow N &= 2 \\ \Rightarrow z_1 &= \frac{1}{2} \cdot 6 / \sqrt{2} = 2.1\text{m} \end{aligned}$$

3.  $L_{e1} = 41.8 / \pi \times 0.15 \times 0.8 [ \sigma'_n \tan 22 + 2 ]$

Where  $\sigma'_n = 1/4 ( 3 + K_a ) \sigma'_v$   
 $K_a = 0.45$

$$\begin{aligned} \Rightarrow \sigma'_n &= 0.86 \times 20 \times z_{1av} [ 1 - 0.25 ] \\ &(\text{ guess } z_{1av} \approx 3.2\text{m} ) \\ \Rightarrow \sigma'_n &= 41\text{kN/m}^2 \\ \Rightarrow L_{e1} &= 5.9\text{m} \end{aligned}$$

Diagram 6:

Lower slope:

$$\begin{aligned} \phi'_{des} &= 22^\circ \\ c'_{des} &= 2\text{kN/m}^2 \\ r_u &= 0.25 \\ \alpha &= 0.8 \end{aligned}$$

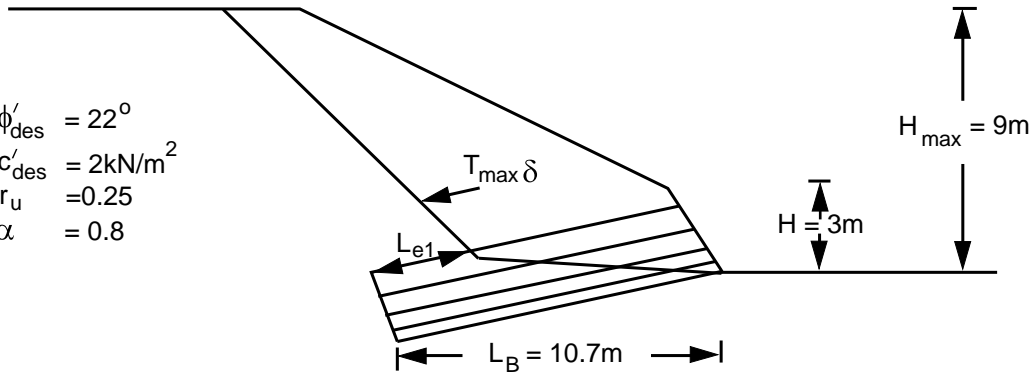

Upper slope:

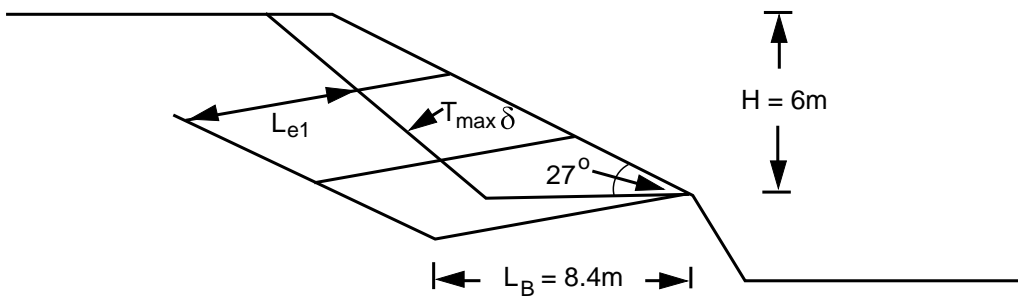

Preliminary nailing layout

