VOLUME 6 ROAD GEOMETRY
SECTION 2 JUNCTIONS

PART 3

TD 16/07

**GEOMETRIC DESIGN OF
ROUNDBOUTS**

SUMMARY

This document sets out the design standards and advice for the geometric design of roundabouts. It supersedes TD 16/93.

INSTRUCTIONS FOR USE

1. Remove contents pages from Volume 6 and insert new contents pages dated August 2007.
2. Remove TD 16/93 from Volume 6, Section 2.
3. Insert new Advice Note TD 16/07 into Volume 6, Section 2.
4. Please archive this sheet as appropriate.

Note: A quarterly index with a full set of Volume Contents Pages is available separately from The Stationery Office Ltd.



THE HIGHWAYS AGENCY



**TRANSPORT
SCOTLAND**

TRANSPORT SCOTLAND



**Llywodraeth Cynulliad Cymru
Welsh Assembly Government**

**WELSH ASSEMBLY GOVERNMENT
LLYWODRAETH CYNULLIAD CYMRU**



**Department for
Regional Development
www.drdni.gov.uk**

**THE DEPARTMENT FOR REGIONAL DEVELOPMENT
NORTHERN IRELAND**

Geometric Design of Roundabouts

Summary: This document sets out the design standards and advice for the geometric design of roundabouts. It supersedes TD 16/93.

REGISTRATION OF AMENDMENTS

Amend No	Page No	Signature & Date of incorporation of amendments	Amend No	Page No	Signature & Date of incorporation of amendments

REGISTRATION OF AMENDMENTS

Amend No	Page No	Signature & Date of incorporation of amendments	Amend No	Page No	Signature & Date of incorporation of amendments

VOLUME 6 ROAD GEOMETRY
SECTION 2 JUNCTIONS

PART 3

TD 16/07

**GEOMETRIC DESIGN OF
ROUNDBOUTS**

Contents

Chapter

1. Introduction
2. Safety at Roundabouts
3. Types of Roundabouts
4. Siting of Roundabouts
5. Road Users' Specific Requirements
6. Design Hierarchy
7. Geometric Design
8. Other Aspects of Design
9. References
10. Enquiries

1. INTRODUCTION

General

1.1 Following a major review of the geometric design of roundabouts (see **TRL Published Project Report PPR206** ‘International comparison of roundabout design guidelines’) and extensive consultation, this document provides details of the latest requirements and recommendations on design principles for safe and efficient roundabouts.

1.2 This document supersedes Standard **TD 16/93 (DMRB 6.2.3)**.

Scope

1.3 Roundabouts are junctions with a one-way circulatory carriageway around a central island. Vehicles on the circulatory carriageway have priority over those approaching the roundabout. This document describes the geometric design of the various types of roundabout for application to new and improved junctions on trunk roads.

1.4 The main types of roundabout are Mini, Compact, Normal, Grade Separated, Signalised and Double Roundabouts (the last being a combination of Mini, Compact or Normal Roundabouts) and are described in Chapter 3.

1.5 This standard applies to Compact, Normal and Grade Separated Roundabouts. Mini-roundabouts are covered by **TD 54 (DMRB 6.2.3)** and Signalised Roundabouts by **TD 50 (DMRB 6.2.3)**. In this document, the term roundabout therefore excludes mini-roundabouts and signalised roundabouts unless otherwise stated.

1.6 Recommendations are given on the selection of roundabout type, geometric layout, visibility requirements and crossfall, with respect to the speed limit on the approach roads, the traffic flow and the level of non-motorised user demand.

1.7 A significant change from **TD 16/93** is the new Compact Roundabout which has single-lane entries and exits, so that only one vehicle can enter or leave it from a given arm at any one time (see Chapter 3).

1.8 Other changes are as follows:

- a) greater emphasis on non-motorised users (see Chapter 5);
- b) design hierarchy (see Chapter 6);
- c) when assessing entry deflection on a roundabout arm, the entry path radius must be checked for **all** turning movements (see paragraphs 7.51 – 7.60);
- d) outward sloping crossfall, such that drainage is away from the centre of the roundabout, may be used at smaller Normal and Compact Roundabouts in urban areas (see paragraph 8.21);
- e) except at Compact Roundabouts in urban areas, the projection of the kerb line of the splitter island or central reserve on the approach should guide drivers around the central island (see paragraph 7.30);
- f) advice is given on limiting visibility to the right on the approach to some roundabout types (see paragraph 8.8);
- g) on larger roundabouts, the use of additional signs and markings is recommended (see paragraph 8.24).

Mandatory Sections

1.9 Mandatory sections of this document are contained in boxes. The Design Organisation must comply with these sections or obtain agreement to a Departure from Standard from the Overseeing Organisation. The remainder of the document contains advice and explanation, which is commended to users for consideration.

Implementation

1.10 This standard must be used forthwith for the design of all schemes for the construction and improvement of trunk roads including motorways currently being prepared, provided that in the opinion of the Overseeing Organisation, this would not result in any significant additional expense or

delay. The Design Organisation must confirm its application to particular schemes with the Overseeing Organisation.

Departures from Standard

1.11 In exceptional situations, the Overseeing Organisation may be prepared to agree to a Departure from Standard where the Standard, including permitted Relaxations, is not realistically achievable. Design Organisations faced by such situations and wishing to consider pursuing this course must discuss any such option at an early stage in design with the Overseeing Organisation. Proposals to adopt Departures from Standard must be submitted by the Design Organisation to the Overseeing Organisation and formal approval received **before** incorporation into a design layout.

Relaxations

1.12 In difficult circumstances, Relaxations may be introduced at the discretion of the Design Organisation, having regard to all relevant local factors, but only where specifically permitted by this Standard. Careful consideration must be given to layout options incorporating Relaxations, having weighed the benefits and any potential disbenefits. Particular attention must be given to the safety aspects (including operation, maintenance, construction and demolition) and the environmental and monetary benefits/disbenefits that would result from the use of Relaxations. The consideration process must be recorded. The preferred option must be compared against options that would meet full standards.

General Principles

1.13 The principal objective of roundabout design is to minimise delay for vehicles whilst maintaining the safe passage of all road users through the junction. This is achieved by a combination of geometric layout features that, ideally, are matched to the flows in the traffic streams, their speed, and to any local topographical or other constraints such as land availability that apply. Location constraints are often the dominating factor when designing improvements to an existing junction, particularly in urban areas.

1.14 Roundabouts should be designed to match forecast demand. They work most efficiently when vehicular flows are reasonably balanced between the arms, but they may also be the optimum choice in other cases, having taken into account the Overseeing Organisation's assessment criteria. However, they may not be appropriate for use with Urban Traffic Control (UTC) or Integrated Demand Management (IDM) systems, or for other circumstances where access control is required.

1.15 Entry width and sharpness of flare are the most important determinants of capacity, whereas entry deflection is the most important factor for safety as it governs the speed of vehicles through the roundabout. The effect of these variables can be predicted using the models given in **TRL Reports LR942** and **LR1120** and incorporated into suitable software.

1.16 The associated traffic signs and road markings can significantly affect the safety and the capacity of a roundabout. Consequently, designers should consider the need for and layout of traffic signs and road markings as an integral part of the design process (see paragraphs 8.24 to 8.32). The **Traffic Signs Regulations and General Directions (TSRGD)** prescribe the designs and conditions of use for traffic signs and road markings. Guidance on the application of **TSRGD** can be found in the **Traffic Signs Manual**. Advice on signing is also given in **Local Transport Note LTN 1/94**.

1.17 The legislation referred to in this document may, in some instances, have a specific Northern Ireland equivalent. For schemes in Northern Ireland, the designer should refer to the Overseeing Organisation for advice.

1.18 Roundabout design must allow for maintenance issues and activities, including landscaping and the need for inspection and service of road studs and markings. Any implications for activities such as road sweeping, general routine maintenance, resurfacing and winter maintenance operations, and the possible need for a maintenance hard standing must be covered.

2. SAFETY AT ROUNDABOUTS

2.1 In 2004 there were about 207,400 personal injury road accidents in Great Britain (**Road Casualties Great Britain, 2004**). Of these, about 18,000 (8.7%) occurred at roundabouts. The proportion of accidents at roundabouts which were fatal was 0.35%, whereas 0.88% of all other junction accidents and 2.2% of link accidents were fatal. This indicates the effectiveness of roundabouts in reducing accident severity. The average accident cost at a roundabout was calculated to be about 68% of that at other junction types and about 47% of that on links. This suggests that on average, roundabouts are safer than other junction types. However, this will not necessarily be the case for all road users or for a particular junction.

2.2 A study undertaken in 2004 (**TRL Unpublished Report UPR/SE/194/05**) determined the accident frequencies (accidents per year) by severity over a five year period (see Table 2/1) for a sample of 1,162 roundabouts. The sample comprised all roundabouts in some local authorities, but only the busier roundabouts in others, making the analysis slightly biased towards busier roundabouts. The table does not include accident rates because only limited reliable flow data were available. The number of accidents per year increases

with the number of arms (because of corresponding increases in the number of potential conflict points and traffic flow. On average, there are more accidents at roundabouts with at least one approach that is dual carriageway compared with roundabouts where none of the approaches are dual carriageway roads. Dual carriageway roundabouts generally have higher levels of traffic.

2.3 Overall, single vehicle accidents accounted for 15% of the total in the sample, but they had a higher severity than multi-vehicle accidents (which include a high proportion of shunt accidents on the approaches). In general, large roundabouts have a higher proportion of single vehicle accidents than smaller roundabouts.

2.4 Flow data were only available for 44 high flow roundabouts. The average accident rate (accidents per million vehicles passing through the junction) at these roundabouts was 36.2.

2.5 Table 2/2 shows the percentage of accidents by type of vehicle and by severity for the sample of 1,162 roundabouts sampled.

Table 2/1: Average Accident Frequency at Roundabouts Between 1999 and 2003

No. of arms	No. of sites	Accident frequency (accidents per year)				Accident severity (% fatal and serious)
		Single carriageway roads	Dual carriageway roads	Grade separated junctions	All roads	
3	326	0.63	1.28	2.70	0.79	9.3
4	649	1.08	2.65	5.35	1.79	7.1
5	157	1.72	3.80	7.67	3.66	7.1
6	30	2.11	4.62	8.71	5.95	5.2
All	1162	1.00	2.60	6.28	1.87	7.2

Table 2/2: Accidents by Type of Vehicle Involved (1999 to 2003)

	Percentage of accidents	Accident severity (% fatal and serious)
Pedal cycles	8.0%	9.5%
Powered two wheelers	14.4%	19.3%
Cars and taxis	76.7%	6.0%
Public Service Vehicles	2.6%	7.8%
Light goods vehicles	6.4%	5.6%
Large goods vehicles	9.3%	8.0%
Pedestrians	2.8%	22.6%

2.6 On average, accidents involving a pedestrian accounted for only 3% of the total. This suggests that roundabouts are relatively safe for pedestrians. However, it should be noted that the majority of roundabouts are sited in rural areas with little or no pedestrian demand. Even at urban roundabouts, the number of pedestrians crossing the road within 20m of the give way line tends to be low because:

- roundabouts are often sited away from city centres;
- pedestrians may prefer to cross away from any flaring, where the road is narrower and traffic movements are more uniform and this may be more than 20m from the give way line.

When pedestrians do cross the road within 20m of the give way line, they are aided by the splitter island, by the lower vehicle speeds and possibly by increased driver alertness in the vicinity of the roundabout. However, accident severity is high for pedestrians (23% compared with 6% for cars).

2.7 On average, pedal cyclists were involved in about 8% of accidents in the sample, although they typically constitute less than 2% of the traffic flow, giving them a much higher involvement rate than cars. Research by **Layfield and Maycock (1986)** showed that the most common type of accident for cyclists at roundabouts is one in which a cyclist on the circulatory carriageway is hit by an entering vehicle.

2.8 Powered Two-Wheelers (PTWs) were involved in 14% of accidents in the sample although again they

represent less than 2% of the flow. The severity of accidents involving these road users was also much higher than for car occupants (19% of accidents being fatal and serious compared with 7% for all vehicles in the sample).

2.9 A study by **Hall and Surl (1981)** showed that, on busy dual carriageway roads with similar traffic flows, there will generally be fewer accidents at a roundabout than at a signalised junction.

2.10 The characteristics of roundabout accidents and their frequencies in relation to geometric layout design requirements were reported in **TRL Report LR1120** 'Accidents at Four-Arm Roundabouts'. The relationships derived in this report provide insights into the way various aspects of design interact to influence the types and frequencies of accidents at roundabouts. These relationships therefore constitute the fundamentals of design for safety. The accident prediction models given in **LR1120** can be used to compare the safety characteristics of alternative designs.

2.11 Comparative data for accident involvement rates at different junction types is given in **TRL Report TR1281** 'Accidents at Urban Mini-roundabouts'.

2.12 Suggested remedial measures for existing roundabouts with a safety problem are given in Chapter 8 of this Standard.

3. TYPES OF ROUNDABOUTS

Normal Roundabouts

3.1 A Normal Roundabout has a kerbed central island at least 4 metres in diameter (Figure 3/1). Its approaches may be dual or single carriageway roads. Usually, a Normal Roundabout has flared entries and exits to allow two or three vehicles to enter or leave the roundabout on a given arm at the same time. If so, its circulatory carriageway needs to be wide enough for two or three vehicles to travel alongside each other on the roundabout itself.

3.2 If a Normal Roundabout has more than four arms, it becomes large with the probability that higher circulatory speeds will result. Either a Double Roundabout or a Signalised Roundabout is a potential solution in these circumstances.

Compact Roundabouts

3.3 A Compact Roundabout (Figure 3/2) has single lane entries and exits on each arm. The width of the circulatory carriageway is such that it is not possible for two cars to pass one another.

3.4 On roads with a speed limit of 40mph or less within 100m of the give way line on all approaches, Compact Roundabouts may have low values of entry and exit radii in conjunction with high values of entry deflection. This design has less capacity than that of Normal Roundabouts, but is particularly suitable where there is a need to accommodate the movement of pedestrians and cyclists. The non-flared entries/exits give the designer more flexibility in siting pedestrian crossings.

3.5 On roads with speed limits exceeding 40mph, the design of Compact Roundabouts is similar to that for Normal Roundabouts, but the single-lane entries and exits are retained.

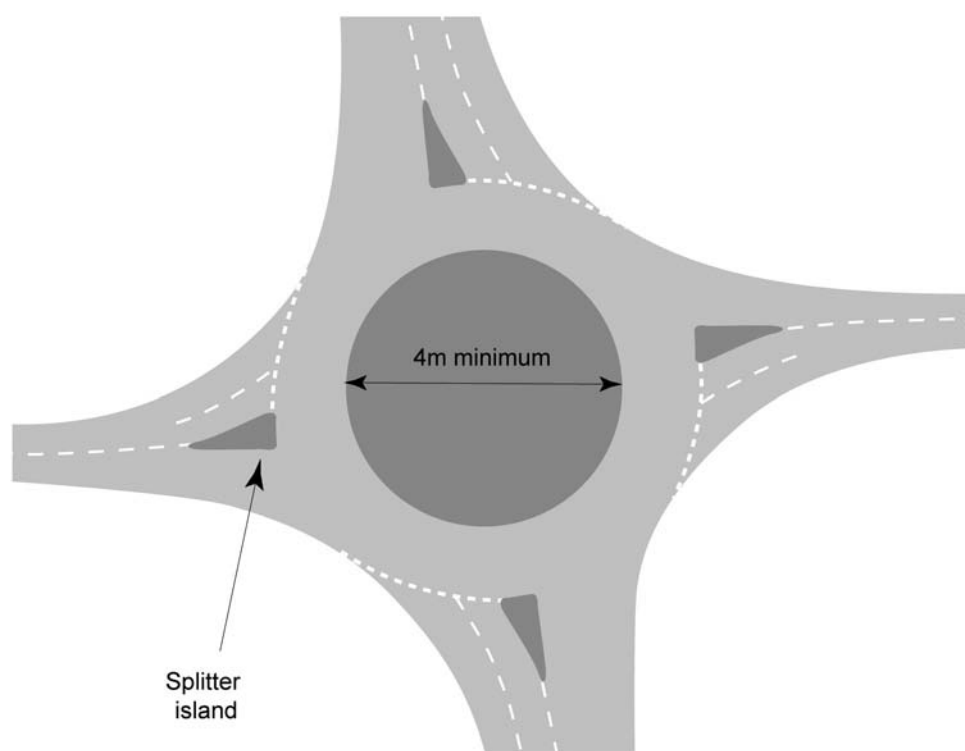

Figure 3/1: Normal Roundabout

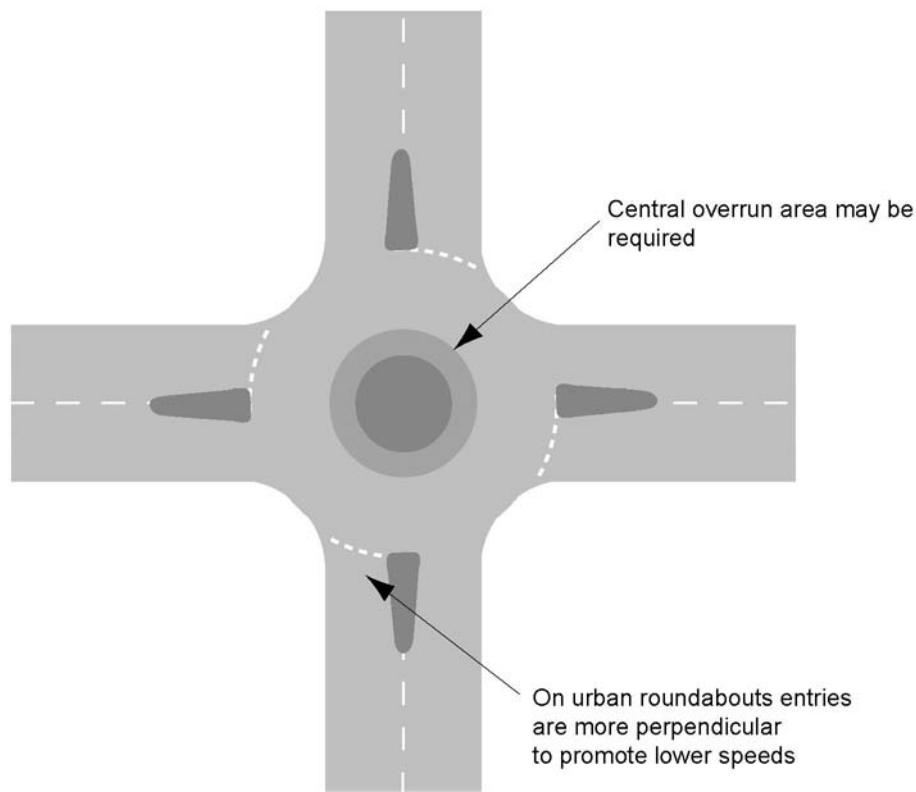

Figure 3/2: Compact Roundabout in an Urban Area

Mini-roundabouts

3.6 A mini-roundabout does not have a kerbed central island. In its place is a flush or domed circular solid white road marking between 1 and 4 metres in diameter, capable of being driven over where unavoidable. See **TD 54 (DMRB 6.2.3)**.

Grade Separated Roundabouts

3.7 A Grade Separated Roundabout has at least one approach coming from a road at a different level. This type of roundabout is frequently employed at motorway junctions, but can also be used to link underpasses, flyovers and other multiple level intersections.

Signalised Roundabouts

3.8 A Signalised Roundabout has traffic signals on one or more of the approaches and at the corresponding point on the circulatory carriageway itself. Further details on the layout of Signalised Roundabouts are given in **TD 50 (DMRB 6.2.3)**.

3.9 Installing traffic signals, with either continuous or part-time operation, at some or all of the entry points (see **DMRB 8.1**) can be appropriate where a roundabout does not naturally self-regulate. This may be for a combination of reasons such as:

- a) a growth in traffic flow;
- b) an overloading or an unbalanced flow at one or more entries;
- c) high circulatory speeds;
- d) significantly different flows during peak hour operation.

3.10 In some cases, it may be possible to achieve the desired result by making suitable changes to the layout and this should be checked using suitable software before installing traffic signals, as this may be cheaper and more effective.

Double Roundabouts

3.11 A Double Roundabout is a junction comprising two roundabouts separated by a short link (see Figure 3/3). The roundabouts may be Mini, Compact or Normal Roundabouts.

3.12 Double Roundabouts can be particularly useful:

- a) for improving an existing staggered junction where they avoid the need to realign one of the approach roads and can achieve a considerable construction cost saving compared with a larger, single island roundabout;
- b) for joining two parallel routes separated by a feature such as a river, a railway line or a motorway;
- c) at overloaded single roundabouts where, by reducing the circulating flow past critical entries, they increase capacity;

- d) at junctions with more than four entries, where they may achieve better capacity and make more efficient use of space with better safety characteristics compared with a large roundabout which may generate high circulatory speeds which result in a loss of capacity and safety.

3.13 A Double Roundabout should be designed as a single system rather than as two individual roundabouts. The link joining the pair of roundabouts is usually short and there is often insufficient distance to change lane. The lane use on the link should be established from the turning volumes feeding it and should be checked so that lane balance is produced on the common link. Reducing the capacity of the entries that feed the common link can prevent traffic blocking back onto the roundabouts themselves, thus increasing the overall capacity.

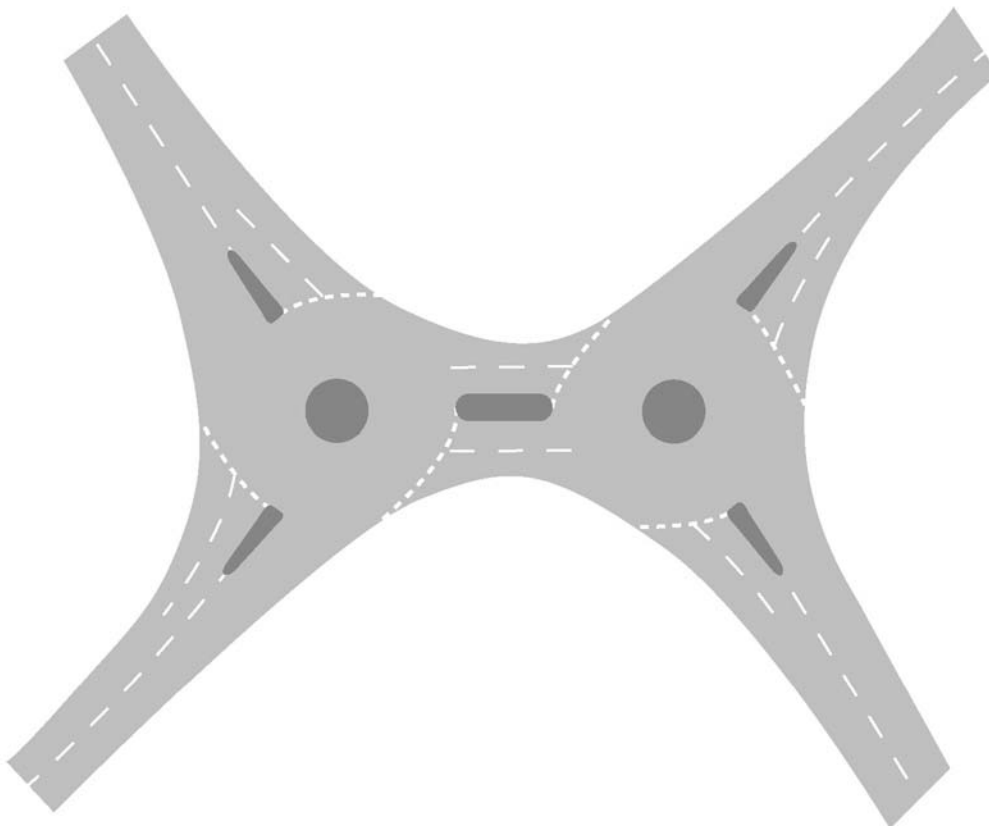

Figure 3/3: Double Roundabout with Short Central Link

4. SITING OF ROUNDABOUTS

4.1 A project appraisal should be carried out in accordance with the Overseeing Organisation's current practices.

4.2 In addition to its natural function as a junction, a roundabout may usefully:

- a) facilitate a significant change in road standard, for example, from dual to single carriageways or from grade separated junction roads to at-grade junction roads, although complete reliance should not be placed on the roundabout alone to act as an indicator to drivers;
- b) emphasise the transition from a rural to an urban or suburban environment (although using one when there are no joining roads is not recommended);
- c) allow U-turns;
- d) facilitate heavy right turn flows.

4.3 The majority of accidents at major/minor priority junctions are associated with right turns. The inconvenience of banned right turns can be mitigated by providing a roundabout nearby.

4.4 Roundabouts are not recommended for at-grade junctions on rural three-lane dual carriageway roads. Under these conditions it is difficult to achieve adequate deflection. However, if a grade separated junction is not achievable, it may be possible to generate suitable deflection by gently curving the approach to the right.

4.5 On single carriageway roads where overtaking opportunity is limited, roundabouts may be sited so as to optimise the length of straight overtaking sections along the route (see **TD 9**, **DMRB 6.1.1**). They can also be used to provide an overtaking opportunity by having a short length of two lanes on the exit arms. The length of these sections will depend on site conditions.

4.6 Roundabouts should preferably be sited on level ground or in sags rather than at or near crests because it is difficult for drivers to appreciate the layout when approaching on an up gradient. However, there is no evidence that roundabouts on crests are intrinsically unsafe if correctly signed and where the visibility

standards have been provided on the approach to the give way line. Roundabouts should not be sited at the bottom of or on long descents.

4.7 Roundabouts in urban areas are not always compatible with Urban Traffic Control (UTC) systems. These systems move vehicles through their controlled areas in platoons by adjusting traffic signal times to suit the required progress. Roundabouts can interfere with platoon movement to the extent that subsequent inflows to downstream traffic signals cannot be reliably predicted, and thus the sequence breaks down. However, in some cases, for example, where there is a heavy right turn flow, the roundabout may be a better option.

4.8 Where several roundabouts are to be installed on the same route, they should be of similar design in the interests of route consistency and hence safety, to the extent that this is possible with the traffic volumes concerned.

4.9 Where a proposed roundabout may affect the operation of an adjacent junction, or vice versa, the interactive effects should be examined. Where appropriate, traffic management measures such as prohibited turns or one-way traffic orders may be considered. The effects of queueing should be examined to check that additional risk is not generated.

5. ROAD USERS' SPECIFIC REQUIREMENTS

Pedestrians

5.1 The types of pedestrian facility available at roundabouts are as follows:

- a) informal crossing;
- b) zebra crossing;
- c) stand-alone signal controlled crossing (Pelican, Puffin or Toucan);
- d) grade separated crossing (underpass for pedestrians, underpass for vehicles or footbridge).

5.2 A dropped kerb and tactile paving must be provided at any crossing (see LTN 2/95).

5.3 Where possible, the splitter island, extended and/or widened as necessary, should be used as a pedestrian refuge. An absolute minimum island width of 1.2m is required, preferably 2.5m. For a staggered signal-controlled crossing, 3m is required. See **Local Transport Notes LTN 2/95, LTN 1/01 and LTN 1/02.**

5.4 The type of facility selected and its design should be in accordance with current recommendations and requirements (LTNs 1/95 and 2/95, TA 90, DMRB 6.3.5 and TA 91, DMRB 5.2.4) and the design hierarchy in Chapter 6.

5.5 If a stand-alone crossing is provided close to the give way line, there will inevitably be consequences for the operation of the roundabout and possibly for safety. An informal or zebra crossing is normally preferred as it avoids the possibility that drivers will confuse the green signal with one controlling flow into the roundabout. Where a signal controlled crossing is located close to the give way line and drivers could confuse the crossing with the roundabout entry, the line should be supplemented by the use of markings to Diagram 1023 and give way signs to Diagram 602 of the **Traffic Signs Regulations and General Directions (TSRGD).**

5.6 Where provided, stand-alone pedestrian crossing facilities should be located to suit pedestrian desire lines. If possible, they should be outside of the flared section to keep the crossing short, as shown in Figure 5/1. Zebra crossings should be located between 5m and 20m from the give way line.

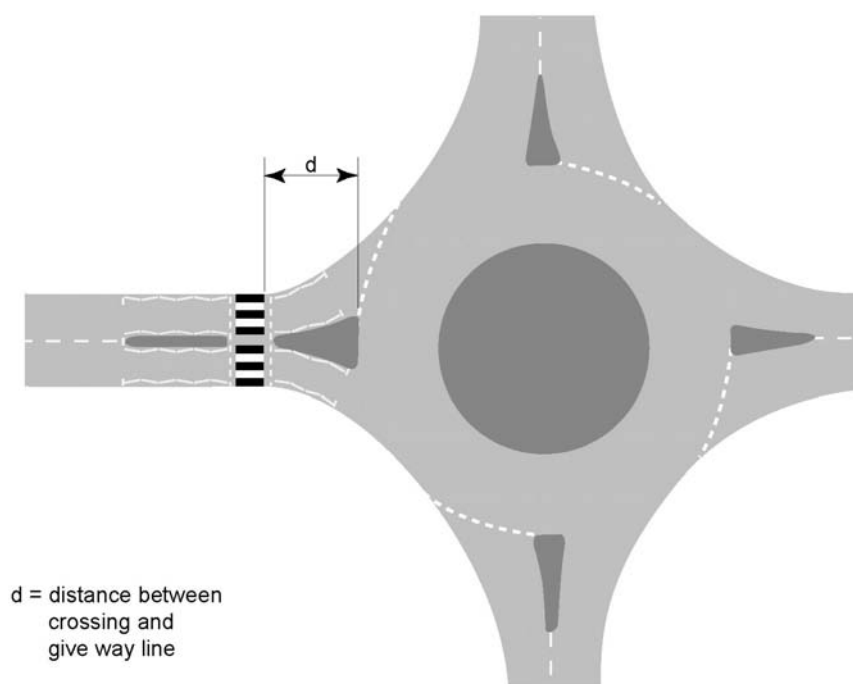

Figure 5/1: Measurement of Distance from Roundabout to Pedestrian Crossing

5.7 Non-staggered signal-controlled crossings should be sited either at 20m or more than 60m from the give way line. It may be advantageous to use the splitter island (extended as necessary) as a central refuge. The central refuge can also be used to form a staggered crossing. See **Local Transport Notes 1/95 and 2/95** and **Traffic Advisory Leaflets 1/01** 'Puffin Pedestrian Crossings' and **1/02** 'The Installation of Puffin Pedestrian Crossings'. Note that if a Puffin crossing is used, a staggered crossing may not be necessary.

5.8 On the approach to the roundabout, a distance of 20m for a signal-controlled crossing will reduce the likelihood of drivers confusing the signal with one controlling flow into the roundabout and it leaves sufficient storage space for vehicles waiting to enter the roundabout. On the exit, a distance of 20m reduces the likelihood that 'blocking back' will occur where traffic queues extend onto the circulatory carriageway and it helps to ensure that drivers are still travelling slowly as they approach the crossing. If the crossing is staggered, the part on the entry arm can be within the 20m to 60m zone.

5.9 Zebra crossings should not be used where the 85th percentile speed exceeds 35mph (if it does, a signal-controlled crossing will be required). If the 85th percentile speed exceeds 50mph, serious consideration should be given to speed reduction measures before installing at-grade crossings. Signal-controlled crossings should be equipped with suitable speed measuring and extension equipment (SA, SD or MOVA) (see **Traffic Advisory Leaflet 2/03** and **Local Transport Note 1/95**).

5.10 **The Zebra, Pelican and Puffin Pedestrian Crossing Regulations and General Directions** lays down the requirements for the general layout of both types of crossing. For areas of carriageway which are tapered, especially those including changes in the number of lanes, it is difficult to provide appropriate designs that are not potentially confusing to drivers.

5.11 Zigzag markings are a requirement at Zebra, Pelican, Puffin, Toucan and Equestrian crossings, but must not be used where the crossing is part of a Signalised Roundabout.

5.12 With the exception of Zebra crossings, central hatching or chevron markings may be used alongside zigzag markings in certain conditions – see Section 15, **Chapter 5** of the **Traffic Signs Manual**.

5.13 For information on the effect of zebra crossings on junction capacity, see **TRL Report SR724**.

5.14 In urban areas, where large numbers of pedestrians are present, the use of guard rails or other means of deterring pedestrians from crossing at inappropriate locations should be considered. Guard railing should not obstruct drivers' visibility; guard railing which is designed to provide intervisibility between drivers and pedestrians is available, but should be checked in case blind spots do occur. Further guidance on the use of guard railing is given in **Inclusive Mobility**.

5.15 Bridges and underpasses may present problems for people with a disability and should only be used when at-grade crossings are deemed inappropriate (see **TA 91, DMRB 5.2.4**).

Cyclists

5.16 When a roundabout intercepts a cycle route, several options are available, none of them without problems. Cyclists can be routed:

- through the roundabout using the circulatory carriageway;
- around the outside of the roundabout using a peripheral cycle track;
- onto a grade separated facility; or
- away from the roundabout altogether.

5.17 Using the circulatory carriageway is best suited to relatively lightly-trafficked situations, particularly Compact Roundabouts in urban areas. It is less safe for cyclists when traffic flows are heavy, especially where the roundabout has been designed to maximise capacity. However, signalling the roundabout mitigates the problems to some extent and also gives an opportunity to provide a more direct route for cyclists across the central island.

5.18 Some authorities have tried providing cycle lanes on the circulatory carriageway of Normal Roundabouts but the results have been mixed and, in some cases, they have made conditions less safe for cyclists. There is insufficient evidence available to be able to advise on this issue here.

5.19 The remaining options may be safer but each one involves additional effort and inconvenience for cyclists. Peripheral cycle tracks increase the distance a

cyclist must travel and the tracks have to cross each arm of the roundabout. These crossings can be controlled or informal, but either type requires cyclists to stop.

5.20 Grade separation for cyclists is expensive and can result in anti-social behaviour. Providing alternative routes so that cyclists can by-pass the roundabout altogether can result in cyclists covering much larger distances.

5.21 In choosing which option to pursue, the designer should take into account the design hierarchy in Chapter 6.

5.22 The location of Toucan crossings should follow the same guidance as that for pedestrian crossings.

5.23 Special consideration should be given to cyclists at segregated left turn lanes. See **TD 51 (DMRB 6.3.5)**.

Equestrians

5.24 The need to install equestrian facilities should be assessed in the same way as for pedestrians, using **Local Transport Note LTN 1/95. Traffic Advisory Leaflet TAL 3/03 'Equestrian Crossings'** covers the additional detail. If a signal controlled crossing for use by riders on horseback is provided, it should preferably be at least 60m from the give way line in order to ensure suitable intervisibility between drivers and equestrians, or at 20m for a non-staggered crossing, as for pedestrians and cyclists. Provision of a holding area with appropriate fencing and some strengthening of verges may be necessary. If there is a requirement to provide facilities for other non-motorised users, they should be installed in parallel (see **TA 91, DMRB 5.2.4**).

Powered Two-Wheelers

5.25 Accidents involving Powered Two-Wheelers (PTWs) can be mitigated to an extent by the use of suitable entry deflection, in the same way as for other vehicles.

5.26 Materials used on the roundabout and its approaches must have suitable skidding and deformation resistance. Irregular surface features must be avoided.

5.27 Ironwork needs to be carefully positioned, avoiding as far as possible the routes that PTWs can be

expected to take through the roundabout. This is not the same as simply avoiding the wheel tracks of four-wheeled vehicles.

5.28 Access chamber covers for buried services should be infilled using material with similar friction properties to that of the surrounding road surface. Concrete infilled covers in an asphalt road are acceptable in this regard.

5.29 Further advice on appropriate surfacing materials for safety aspects of drainage features is given in **HD 36 (DMRB 7.5.1)** and **HA 83 (DMRB 4.2.4)**. See **IHE Guidelines for Motorcycling** for more details on PTW issues.

Large Goods Vehicles

5.30 The problem of large goods vehicles (defined in this Standard as those over 3.5 tonnes) overturning or shedding their loads at roundabouts has no simple solution in relation to layout geometry. Whilst there are only about 50 to 60 personal injury accidents a year in this category, there are thought to be considerably more damage-only accidents. Load shedding often leads to congestion and delay and is expensive to clear, especially if it occurs at a major roundabout.

5.31 Experience suggests that at roundabouts where these problems persist, there are frequently combinations of the following geometric features:

- long straight high speed approach;
- inadequate entry deflection;
- low circulating flow combined with excessive visibility to the right;
- significant tightening of the turn radius partway round the roundabout.

5.32 Additional features that may contribute to the problem are excessive:

- crossfall changes on the circulatory carriageway or the exit;
- outward sloping crossfall on a nearside lane of the circulatory carriageway;
- entry deflection.

5.33 An incipient problem for some vehicles may be present even if speeds are low. Research has shown that

an articulated large goods vehicle with a centre of gravity height of 2.5m above the ground can overturn on a 20m radius bend at speeds as low as 15mph (24kph). See **TRL Report LR788**.

5.34 Layouts designed in accordance with the recommendations in this document should mitigate the above problems, although particular attention should be paid during construction to ensure that pavement surface tolerances are complied with and that abrupt changes in crossfall are avoided.

6. DESIGN HIERARCHY

Selection of Roundabout Type and Provision for Non-motorised Users

6.1 The choice of roundabout type is governed by a combination of factors including:

- whether the approach roads are single or dual carriageway (or grade separated);
- the speed limit on the approach roads;
- the level of traffic flow;
- the level of non-motorised user (NMU) flow;
- other constraints such as land-take.

6.2 Reference should be made to the Overseeing Organisation's current guidance on deriving design flows.

6.3 Table 6/1 gives the attributes of the different roundabout types, and indicates the normal type of provision for cyclists and pedestrians where there is sufficient demand to justify them. Alternatives are given in **TA 91 (DMRB 5.2.4)** and in Chapter 5. Grade separation for non-motorised users is the best option at high speed roundabouts, but may not be cost-effective.

Table 6/1: Selection of Roundabout Type and Recommended Provision for NMUs

Roundabout category	Highest class of road on any approach	Highest speed limit within 100m on any approach	Highest two-way AADT on any approach	Recommended cyclist provision	Recommended pedestrian provision	Combined cycle and pedestrian provision	Roundabout type
1	Grade separated entry/exit	Any	Any	Signal controlled/grade separated ¹	Signal controlled/grade separated ¹	Signal controlled/grade separated ¹	Grade Separated
2	Dual carriageway	>40mph	Any	Signal controlled/grade separated ¹	Signal controlled/grade separated ¹	Signal controlled/grade separated ¹	Normal
3	Single carriageway	>40mph	>8,000	Signal controlled ¹	Signal controlled ¹	Signal controlled ¹	Normal
4	Single carriageway	>40mph	<8,000	Cyclists mix with traffic	Informal	N/A	Compact
5	Dual carriageway	≤ 40mph	>25,000	Signal controlled	Signal controlled	Signal controlled	Normal
6	Dual carriageway	≤40mph	16,000-25,000	Signal controlled	Zebra ² or signal controlled	Signal controlled	Normal
7	Dual carriageway	≤ 40mph	<16,000	Informal	Informal or zebra ²	Informal	Normal
8	Single carriageway	≤ 40mph	>12,000	Signal controlled	Zebra ²	Signal controlled	Normal
9	Single carriageway	≤ 40mph	8,000-12,000	Informal	Informal or zebra ²	Informal or signal-controlled ²	Normal or Compact
10	Single carriageway	≤ 40mph	<8,000	Cyclists mix with traffic	Informal	Informal	Compact

¹ Signal controlled crossing to be provided only if warranted by site-specific conditions; an alternative is grade separated provision.

² Zebra crossings should not be used where the 85th percentile speed exceeds 35mph (see paragraph 5.9).

7. GEOMETRIC DESIGN

Central Area of Roundabout

Inscribed Circle Diameter

7.1 The inscribed circle diameter D of the roundabout is the diameter of the largest circle that can be fitted into the junction outline. Figures 7/1 and 7/2 illustrate this for a circular roundabout and a Double Roundabout at a 'scissors' crossroads, respectively.

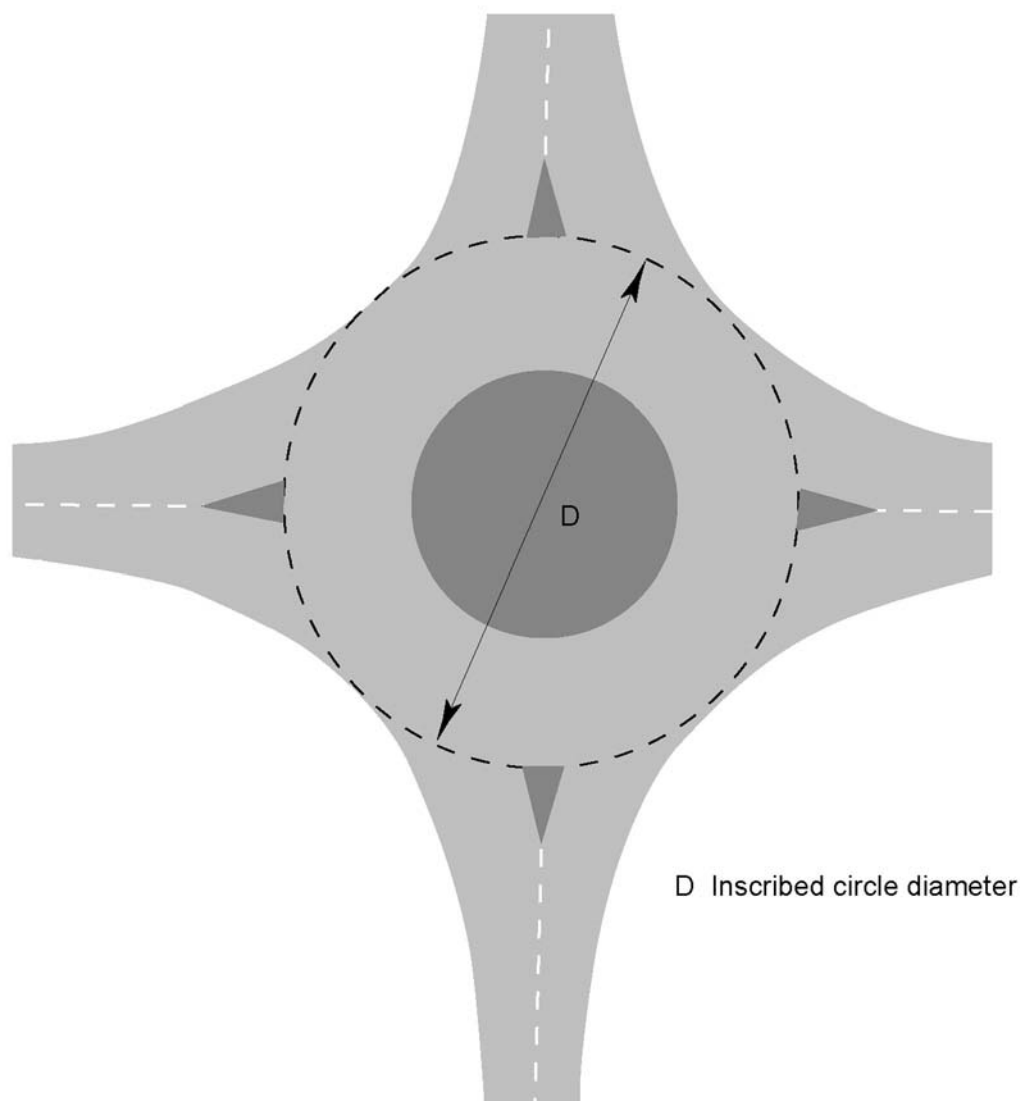

Figure 7/1: Inscribed Circle Diameter at a Normal or Compact Roundabout with a Symmetric Outline

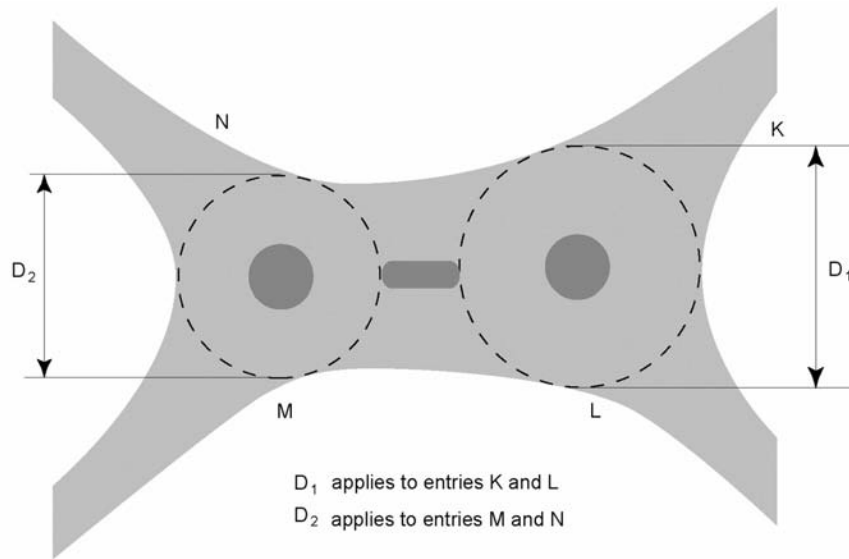

Figure 7/2: Inscribed Circle Diameter at a Double Roundabout

7.2 Where the outline is asymmetric, the local value in the region of the entry should be used.

7.3 The inscribed circle diameter of a Normal Roundabout should not exceed 100m. Large inscribed circle diameters can lead to vehicles exceeding 30mph on the circulatory carriageway.

7.4 The inscribed circle diameter at existing Grade Separated Roundabouts typically exceeds 100m and this can result in high circulating speeds which create operational difficulties. Designers need to be mindful of this when designing new Grade Separated Roundabouts and might need to consider mitigation measures. One way to avoid the problem is to use a single bridge with a roundabout at each end.

7.5 The minimum value of the inscribed circle diameter for a Normal or Compact Roundabout is 28m. This is the smallest roundabout that can accommodate the swept path of the 'Design Vehicle'. See paragraph 7.15.

7.6 If the inscribed circle diameter lies between 28m and 36m, a Compact Roundabout should be considered if the traffic flows can be accommodated.

Circulatory Carriageway

7.7 The circulatory carriageway of Normal or Compact Roundabouts should generally be circular and of constant width. However, at complex roundabouts, for example where spiral markings are used, the width

should be in line with traffic demand. Tight bends should be avoided as they can increase the likelihood of load shedding by large goods vehicles. They can also cause loss of control accidents, particularly for powered two wheelers.

7.8 The width of the circulatory carriageway must be between 1.0 and 1.2 times the maximum entry width (see paragraphs 7.22 – 7.29), excluding any overrun area (see Figure 7/4).

7.9 At Normal and Grade Separated Roundabouts, the width of the circulatory carriageway should not exceed 15 metres. At Compact Roundabouts, it should not exceed 6m, although an additional overrun area may be required for small values of inscribed circle diameter, depending on the types of vehicles using the roundabout (see Figure 7/4).

7.10 Short lengths of reverse curve, where two consecutive tangential circular arcs curve in opposite directions, should be avoided between entry and adjacent exits. This can be achieved by linking the curves with a short straight section. Reducing the size of the inscribed circle diameter or converting to a Double Roundabout can also eliminate the problem. Where there is a considerable distance between the entry and the next exit, such as at three-arm roundabouts, reverse curvature is acceptable (see Figure 7/3).

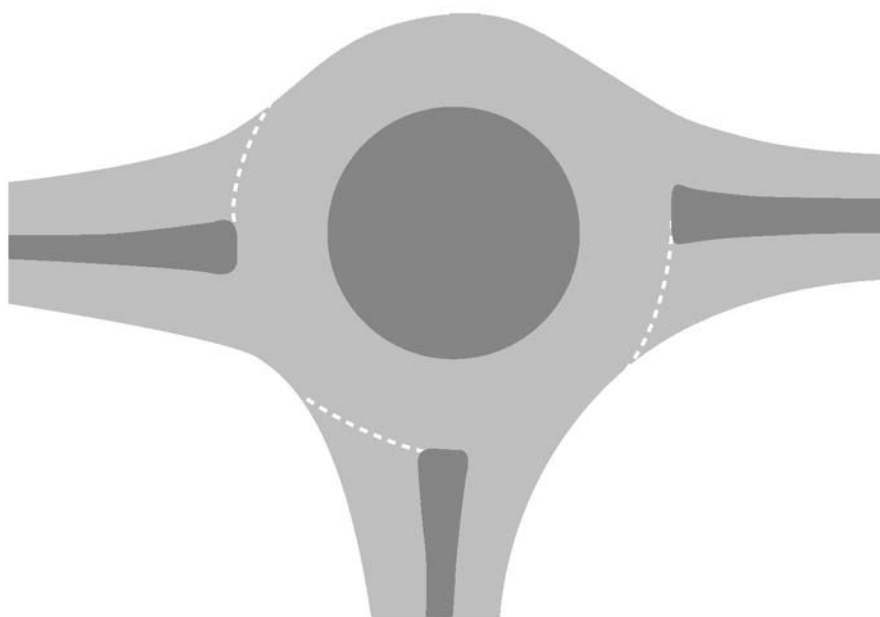

Figure 7/3: Three-arm Roundabout Illustrating Reverse Curvature

7.11 There may be situations where the turning proportions are such that one section of the circulatory carriageway has a relatively low flow, resulting in an unused area of carriageway, usually adjacent to a splitter island:

- For larger roundabouts, the circulatory carriageway can be reduced in width by extending the splitter island, preferably using kerbs although it can be achieved through markings. This method of reducing circulatory width may also be adopted as an interim measure in the early years of a scheme. At the same time, the offside entry lane may be taken out of use, for example, by the use of coloured or textured surfacing or hatched markings.
- For smaller roundabouts, increasing the size of the central island is a more appropriate method of interim circulatory carriageway reduction, preferably by physical means but alternatively using coloured surfacing or hatched markings.

7.12 Hatching should not be used to reduce the entry width in areas adjacent to pedestrian facilities. It cannot be used in the controlled area of a zebra or signal controlled crossing.

Central Island

7.13 The central island should be circular and at least 4 metres in diameter. (Mini-roundabouts have central markings rather than kerbed islands with diameters of up to 4 metres capable of being driven over where unavoidable – refer to **TD 54, DMRB 6.2.3.**)

7.14 The inscribed circle diameter, the width of the circulatory carriageway and the central island diameter are interdependent: once any two of these are established, the remaining measurement is determined automatically.

7.15 The Design Vehicle is an articulated vehicle with a single axle at the rear of the trailer, of length 15.5 metres (see **TRL Report SR662**). The turning space requirements of this vehicle on a roundabout with an inscribed circle diameter of between 28m and 36m are shown in Figure 7/4. Although this type of vehicle is not common on UK roads, its turning requirements are greater than those for all other vehicles within the normal maximum dimensions permitted in the current **Vehicle Construction and Use Regulations**, or likely to be permitted in the near future. The requirements for other vehicles (including an 11 metres long rigid vehicle, 12m long coach, 15m bus, 17.9m ‘bendibus’, 18.35m drawbar-trailer combination, and a 16.5m articulated vehicle) are less onerous.

7.16 It should be noted that the swept path for the Design Vehicle may impinge slightly (by up to 0.3m) into either the inner or outer 1m clearance allowance. Given the anticipated frequency of this type of vehicle, this is not considered to be particularly significant and the dimensions in Figure 7/4 should not be increased accordingly.

7.17 In order to ensure that light vehicles encounter sufficient entry deflection at Compact or small Normal

Roundabouts, an overrun area (i.e. a raised low profile area around the central island) may be necessary (Figure 7/4). It should be capable of being mounted by the trailers of large goods vehicle, but be unattractive to cars e.g. by having a slope and/or a textured surface.

7.18 The profile dimensions of the overrun area must comply with **The Highways (Traffic Calming) Regulations (1999)** and **Traffic Advisory Leaflet TAL 12/93 'Overrun areas'**.

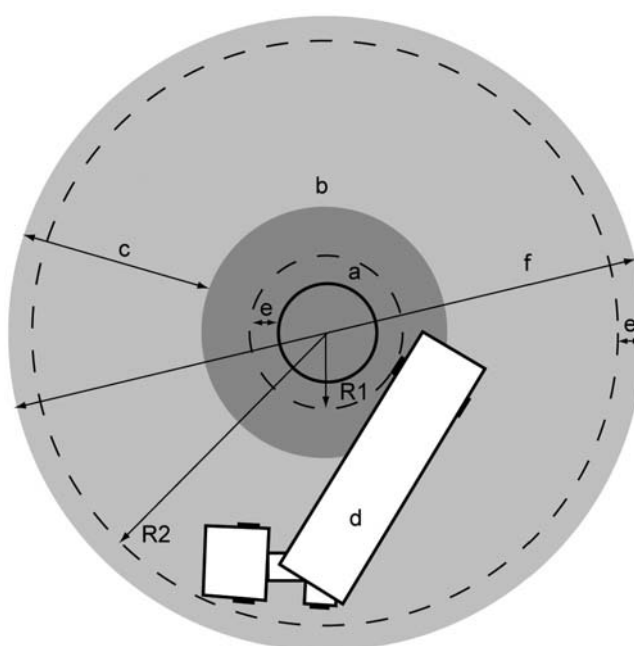

- a Main central island
- b Central overrun area, where provided
- c Remaining circulatory carriageway width = 1.0-1.2 x maximum entry width
- d Vehicle
- e 1m clearance minimum
- f Inscribed Circle Diameter

Central Island Diameter (m)	R1(m)	R2(m)	Minimum ICD (m)
4.0	3.0	13.0	28.0
6.0	4.0	13.4	28.8
8.0	5.0	13.9	29.8
10.0	6.0	14.4	30.8
12.0	7.0	15.0	32.0
14.0	8.0	15.6	33.2
16.0	9.0	16.3	34.6
18.0	10.0	17.0	36.0

In these cases no splitter islands should protrude within the inscribed circle diameter.

Figure 7/4: Turning Widths Required for Smaller Normal or Compact Roundabouts

Splitter Islands

7.19 Splitter islands are used on each arm, located and shaped so as to separate and direct traffic entering and leaving the roundabout. They are usually kerbed, but if there is insufficient space to accommodate a kerbed island, they may consist entirely of markings. Markings may also be used to extend a splitter island on the approach, the exit or the circulatory carriageway. Kerbed splitter islands can act as pedestrian refuges provided that they are large enough to give adequate safe standing space for accompanied wheelchair users and pedestrians with pushchairs or pedal cycles (see paragraph 5.3). Signs and other street furniture can be sited on kerbed islands provided that there is sufficient room to maintain the required clearances.

Entries

7.20 A number of variables need to be considered in selecting an entry design which is safe and has adequate capacity. These variables are:

- approach half width;
- entry width;
- entry flaring;
- entry angle;

and are described below.

Approach Half Width

7.21 The approach half width, v , is the width of the approach carriageway, excluding any hatching, in advance of any entry flare (see Figure 7/5). It is the shortest distance between the median line, or the edge of the central reserve on dual carriageway roads, and the nearside edge of the road. Where there is white edge lining or hatching, the measurement should be taken between markings rather than kerb to kerb.

Entry Width

7.22 The entry width, e , is the width of the carriageway at the point of entry. It is measured from the point A at the right hand end of the give way line along the normal to the nearside kerb (see Figure 7/5). For capacity assessment, the measurement should be taken as the total width of the lanes which drivers are likely to use i.e. the effective width, which is normally between any white edge lining or hatching. Where the alignment of the entry lanes is as described in paragraph 7.30, the entry width and the effective entry width are the same.

7.23 Entry width is a key factor affecting capacity, in conjunction with length and sharpness of flare (see **TRL Report LR942**). One or two extra lanes should be added to the approach at a Normal or Grade Separated Roundabout. However, as a general rule not more than two lanes should be added and no entry should be more than four lanes wide.

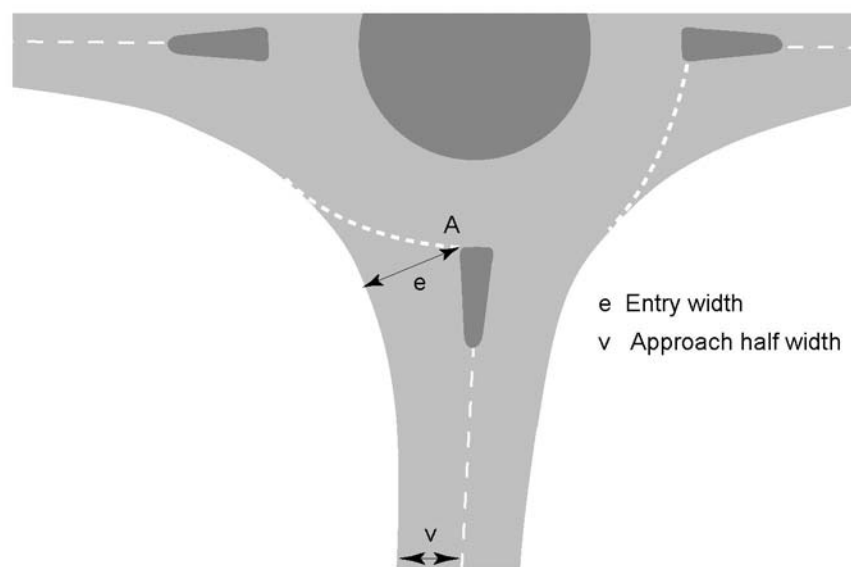

Figure 7/5: Approach Half Width and Entry Width

7.24 Lane widths at the give way line (measured along the normal to the nearside kerb, as for entry width) must be not less than 3m or more than 4.5m, with the 4.5m value appropriate at single lane entries and values of 3 to 3.5m appropriate at multilane entries.

7.25 On a single carriageway approach to a Normal Roundabout, the entry width must not exceed 10.5m. On a dual carriageway approach to a Normal Roundabout, the entry width must not exceed 15m.

7.26 If flaring is provided, tapered lanes should have a minimum width of 2.5m.

7.27 On a single-carriageway road, where predicted flows are low and increased lane width is not operationally necessary, a Compact Roundabout with single lane entries should be used. The entry may need to be closed to carry out any form of maintenance so the design of traffic management for maintenance should be discussed at an early stage in the design process with the Maintaining Organisation.

7.28 The development of entry lanes must take account of the anticipated turning proportions and

possible lane bias, since drivers often have a tendency to use the nearside lane. The use of lane bifurcation where one lane widens into two should maximise use of the entry width. The use of very short offside lanes is not recommended as they tend to be used infrequently in practice with the result that debris collects on the road surface and forms a safety hazard, particularly for two-wheeled vehicles.

7.29 For highway improvement schemes on trunk roads, it is usual to consider design year flows sometime after opening. This can result in roundabout entries with too many lanes for initial flows, subsequently leading to operational problems. A layout based on projected flows will determine the eventual land requirements for the roundabout, but for the early years it may be necessary for the designer to consider an interim stage. This approach can result in reduced entry widths and entry lanes. See paragraph 7.11 for interim solutions.

Alignment of Entry Lanes

7.30 The alignment of entry lanes is critical. Except at Compact Roundabouts in urban areas, the kerbline of the splitter island (or central reserve in the case of a dual carriageway) should lie on an arc which, when projected forward, meets the central island tangentially (see Figure 7/6) in order to reduce the likelihood of vehicle paths overlapping.

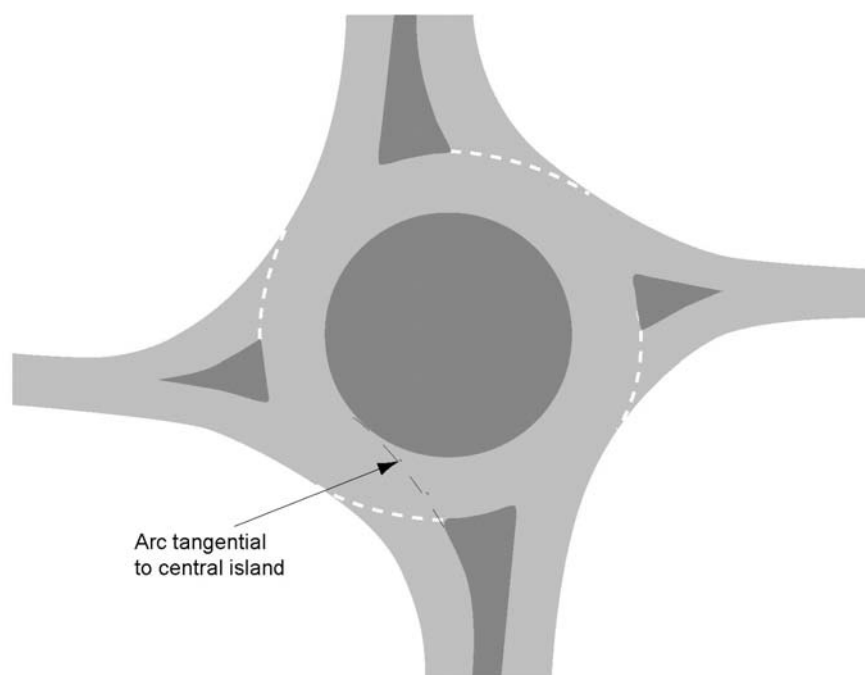

Figure 7/6: Example Showing an Arc Projected Forwards from the Splitter Island and Tangential to the Central Island

Design of Multilane Entries

7.31 On multilane entries, it is important to ensure that entries are used equally in order to avoid the situation where some lanes exceed capacity and others are underused. On flared entries, the queue from an overused lane may back up and block access to other lanes.

Entry Flaring

7.32 Entry flaring is localised widening at the point of entry. Normal Roundabouts usually have flared entries

with the addition of one or two lanes at the give way line to increase capacity. Single lane entries e.g. those at Compact Roundabouts, should be slightly flared to accommodate large goods vehicles. Even a small increase in entry width may increase capacity.

7.33 The average effective flare length, l' , is the average length over which the entry widens. It is the length of the curve CF' , shown in Figure 7/7. The definition and nomenclature are those used in **TRL Report LR942**.

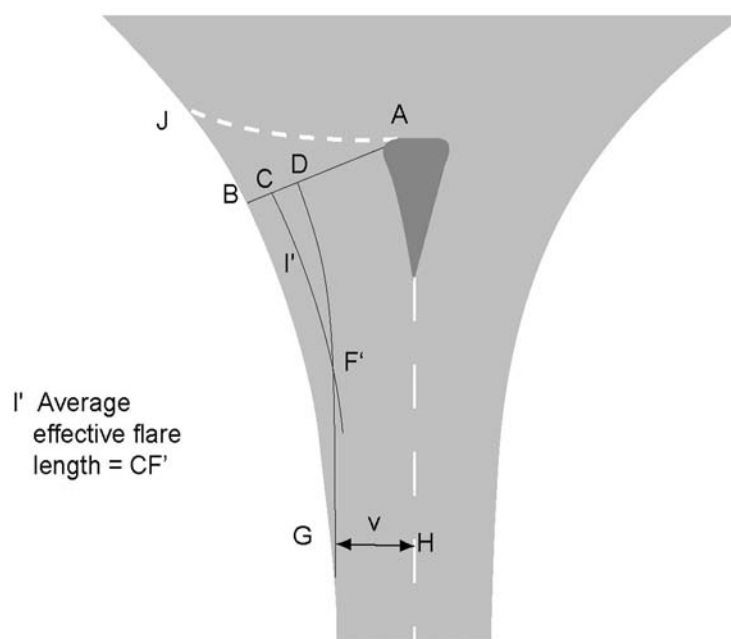

Notes:

1. The nomenclature follows that in **TRL Report LR942**.
2. $AB = e$ (entry width).
3. $GH = v$ (approach half width at point G which is the best estimate of the start of the flare).
4. GD is parallel to AH and distance v from AH (v is measured along a line perpendicular to both AH and GD and, therefore, the length of AD is only equal to v if AB is perpendicular to the median at A).
5. CF' is parallel to BG and distance $\frac{1}{2} BD$ from the kerbline BG.

Figure 7/7: Average Effective Flare Length

7.34 To determine the average effective flare length, l' :

- construct curve GD parallel to the median HA (centre line or edge of central reserve or splitter island) and distance v from it;
- construct curve CF' parallel to curve BG (the nearside kerb) and at a constant distance of $\frac{1}{2} BD$ from it, with F' the point where CF' intersects line DG;
- the length of curve CF' is the average effective flare length l' .

7.35 In cases where the line AB is **not** perpendicular to the median, the length AD will differ slightly from v .

7.36 The total length of the entry widening (BG) will be about twice the average effective flare length.

7.37 The capacity of an entry can be improved by increasing the average effective flare length. Suitable values of l' can be determined using the capacity relations developed in **TRL Report LR942**. The results will depend on the available land take as similar levels of capacity can be obtained with a variety of flare lengths and entry widths. A minimum length of about 5m in urban areas and 25m in rural areas is desirable, but capacity will be the determining factor.

7.38 Effective flare lengths greater than 25m may improve the geometric layout but have little effect in increasing capacity. If the effective flare length exceeds 100m, the design becomes one of link widening. Where the design speed is high, entry widening should be developed gradually with no sudden changes in direction.

7.39 The sharpness of flare, S , is defined by the relationship:

$$S = 1.6 [e-v] / l'$$

7.40 It is a measure of the rate at which extra width is developed in the entry flare. The value of S will depend on the available land-take and the capacity required. Values of S greater than unity correspond to sharp flares and smaller values ($0 \leq S \leq 1$) to gradual flares. Long gradual flares are most efficient as they make better use of the extra width but sharp flares are more easily achieved in terms of land take. Sharp flares can still give significant increases in capacity and are appropriate where there is pedestrian crossing demand. See **TRL Report LR942**.

7.41 The entry width and the flare length are related. The capacity of a wide entry combined with a short flare can be similar to that of a narrow entry combined with a long flare. There are many intermediate combinations of e and l' that will have the same capacity.

7.42 Although entry width and sharpness of flare (which is a function of flare length and widening) have the largest effect on capacity, other variables such as entry angle and entry radius can still be important. When capacity is at a premium, small changes in these variables can sometimes provide a bigger increase in capacity than making a large change in a single variable.

Entry Angle

7.43 The entry angle, ϕ , serves as a geometric proxy for the conflict angle between entering and circulating traffic streams. There are two different methods for its measurement, depending on the size of the roundabout.

7.44 For a large roundabout where the arms are well separated, the angle measured is in effect that between the projected path of an entering vehicle and the path of a circulating vehicle (see Figure 7/8). To determine the entry angle:

- construct the curve EF as the locus of the mid-point between the nearside kerb and the median line (or the edge of any splitter island or central reserve);
- construct BC as the tangent to EF at the give way line;
- construct the curve AD as the locus of the mid-point of (the used section of) the circulatory carriageway (a proxy for the average direction of travel for traffic circulating past the arm);
- the entry angle, ϕ , is the acute angle between BC and the tangent to AD.

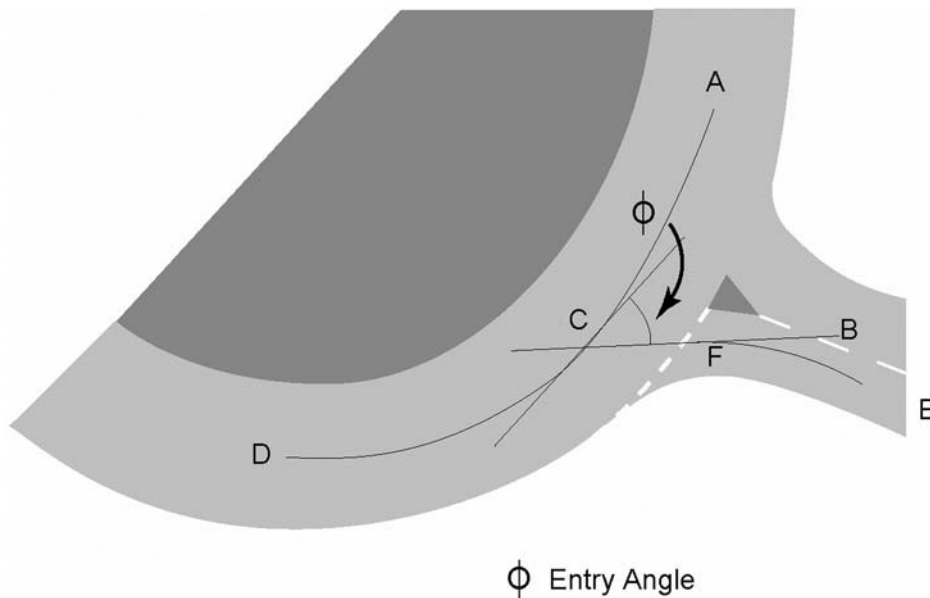

Figure 7/8: Entry Angle at a Larger Roundabout

7.45 For small Normal or Compact Roundabouts, the entry angle is measured as shown in Figure 7/9. This construction is used when there is insufficient separation between entry and adjacent exit to be able to define the path of the circulating vehicle clearly. In this case, circulating traffic which leaves at the following exit will be influenced by the angle at which that arm joins the roundabout. The angle between the projected entry and exit paths is measured and then halved to find ϕ :

- construct line BC as in Figure 7/8;
- construct the curve JK in the next exit as the locus of points midway between the nearside

kerb and the median line (or the edge of any splitter island or central reserve);

- construct the line GH as the equivalent of line BC i.e. the tangent to the curve JK at the point where JK intersects the border of the inscribed circle;
- the lines BC and GH intersect at L. The entry angle, ϕ , is half of angle HLB.

$$\phi = [\text{angle HLB}]/2$$

Note that if angle GLB exceeds 180 degrees, ϕ is defined as zero.

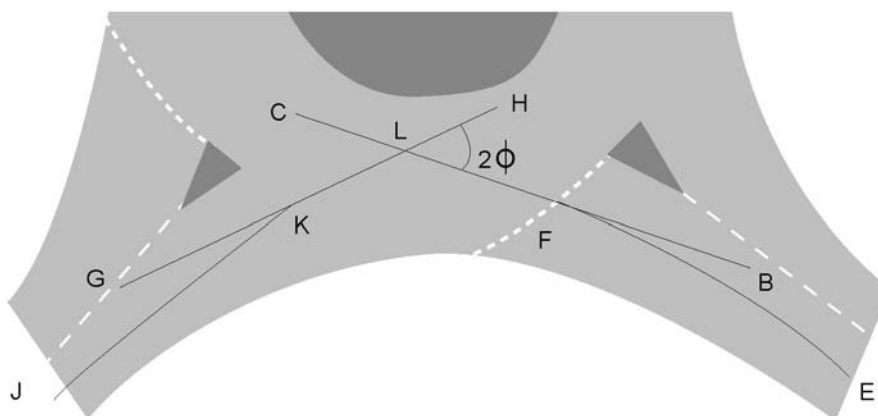

Figure 7/9: Entry Angle at a Smaller Roundabout

7.46 If it is not clear which of the two methods should be used, the following should clarify the situation. All three vehicle paths (entry, exit and circulatory carriageway medians) should be constructed, and the entry and exit paths projected towards the roundabout centre. The choice of construction for ϕ depends on where these projections meet: if the meeting point is closer to the centre of the roundabout than the arc of the circulatory carriageway median, then the construction shown in Figure 7/8 should be used; if they meet outside that area, then the construction illustrated in Figure 7/9 should be used. In the limiting case where all three medians intersect at a point, it is common for the circulatory carriageway median approximately to bisect the angle between the other two medians, so that the two methods become equivalent.

7.47 The entry angle, ϕ , should lie between 20 and 60 degrees. Low entry angles force drivers to look over their shoulders or use their mirrors to merge with circulating traffic. Large entry angles tend to have lower capacity and may produce excessive entry deflection which can lead to sharp braking at entries,

accompanied by shunt accidents, especially when approach speeds are high.

Entry Kerb Radius

7.48 The entry kerb radius, r , is the minimum radius of curvature of the nearside kerb line over the distance from 25m ahead of the give way line to 10m downstream of it (see Figure 7/10). It is the radius of the best fit circular curve over a length of 25m.

7.49 The entry kerb radius should be not less than 10m. Except at Compact Roundabouts, if the approach is intended for regular use by large goods vehicles, the value should be not less than 20m. However, entry kerb radii of 100m or more will tend to result in inadequate entry deflection.

7.50 Although entry capacity can be increased by increasing the entry kerb radius, once its value reaches 20m, further increases only result in very small capacity improvements. Reducing the entry kerb radius below 15m reduces capacity.

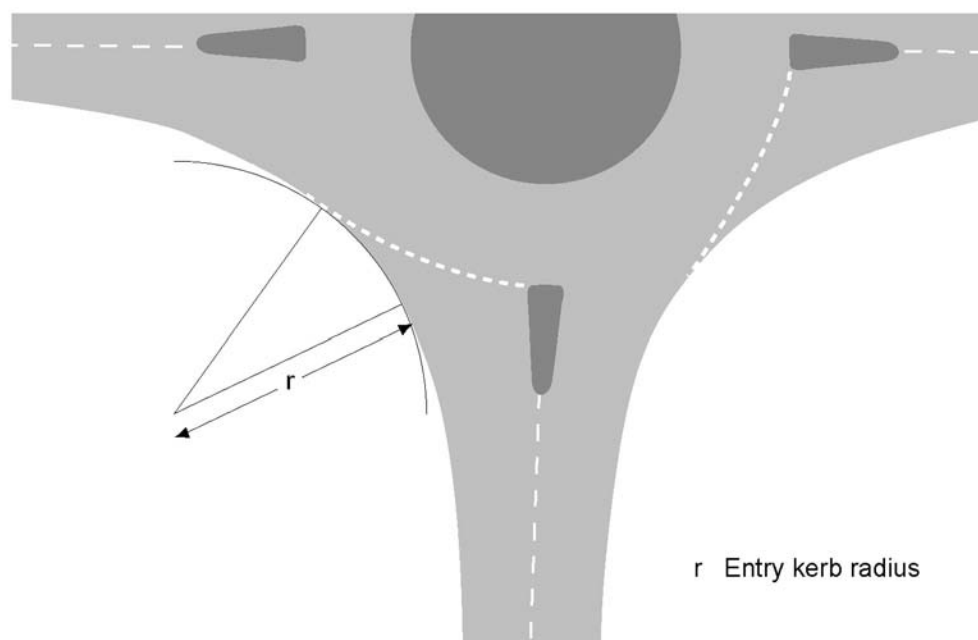

Figure 7/10: Entry Kerb Radius

Entry Path Radius

7.51 The entry path radius (or its inverse, the entry path curvature) is a measure of the deflection to the left imposed on vehicles entering a roundabout. It is the most important determinant of safety at roundabouts because it governs the speed of vehicles through the junction and whether drivers are likely to give way to circulating vehicles.

7.52 To determine the entry path radius, the fastest path allowed by the geometry is drawn. This is the smoothest, flattest path that a vehicle can take through the entry, round the central island and through the exit (in the absence of other traffic) (see Figures 7/11 to 7/14).

7.53 The path is assumed to be 2m wide so that the vehicle following it would maintain a distance of at

least one metre between its centreline and any kerb or edge marking. The path starts 50m in advance of the give way line.

7.54 The construction of the path is a matter of personal judgement. Results should be checked by more than one designer for comparison.

7.55 The smallest radius of this path on entry that occurs as it bends to the left before joining the circulatory carriageway is called the entry path radius. Note that this is different to, and should not be confused with, the entry kerb radius as described in paragraphs 7.48 to 7.50. The entry path radius can be measured by applying suitable templates to the curve in the vicinity of the give-way line (see Figures 7/11 to 7/14). It is the radius of the best fit circular curve over a length of 25m.

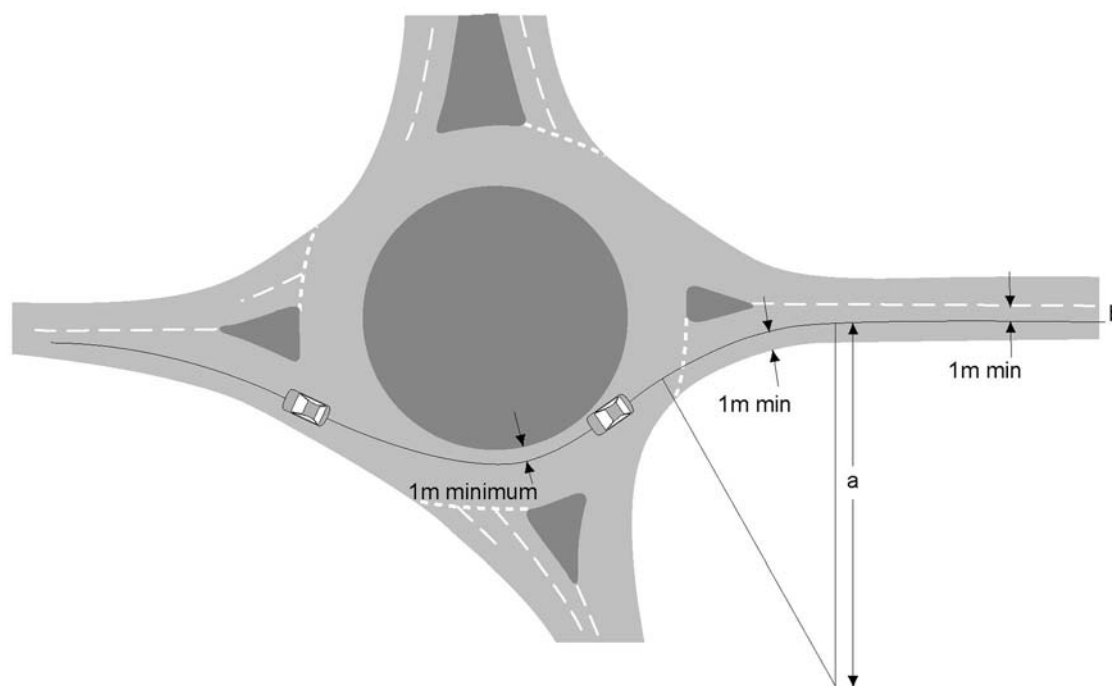

- a Entry path radius should be measured over the smallest best fit circular curve over a distance of 25m occurring along the approach entry path in the vicinity of the give way line, but not more than 50m in advance of it.
- b Commencement point 50m from the give way line and at least 1m from the nearside kerb or centre line (or edge of central reserve)

Figure 7/11: Determination of Entry Path Radius for Ahead Movement at a 4-arm Roundabout

7.56 The entry path radius must be checked for all turning movements. It must not exceed 70m at Compact Roundabouts in urban areas (where the speed limit and the design speed within 100m of the give way line on any approach do not exceed 40mph and 70kph respectively). At all other roundabout types, the entry path radius must not exceed 100m.

7.57 In urban areas, space restrictions, coupled with the turning requirements of large goods vehicles, may necessitate a small Normal or Compact Roundabout which cannot provide sufficient entry deflection by means of the central island alone. In this case, deflection should be generated by enlarging splitter islands or by providing a central overrun area for large goods vehicles (see paragraphs 7.17 and 7.18). Where an overrun area is provided and is effective in deterring drivers of light vehicles from using it, the entry path radius should be measured relative to the perimeter of this area rather than that of the central island.

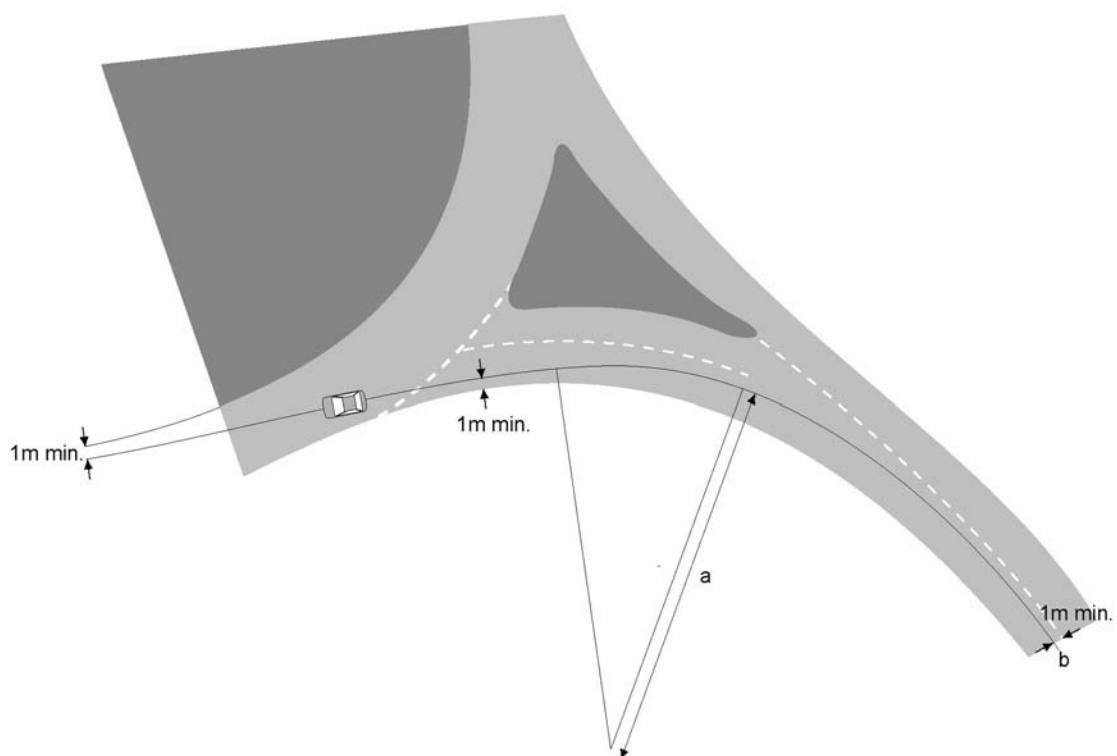

- a Entry path radius should be measured over the smallest best fit circular curve over a distance of 25m occurring along the approach entry path in the vicinity of the give way line, but not more than 50m in advance of it.
- b Commencement point 50m from the give way line and at least 1m from nearside kerb or centre line

Figure 7/12: Determination of Entry Path Radius for the Left Turn where the Approach Curves to the Left

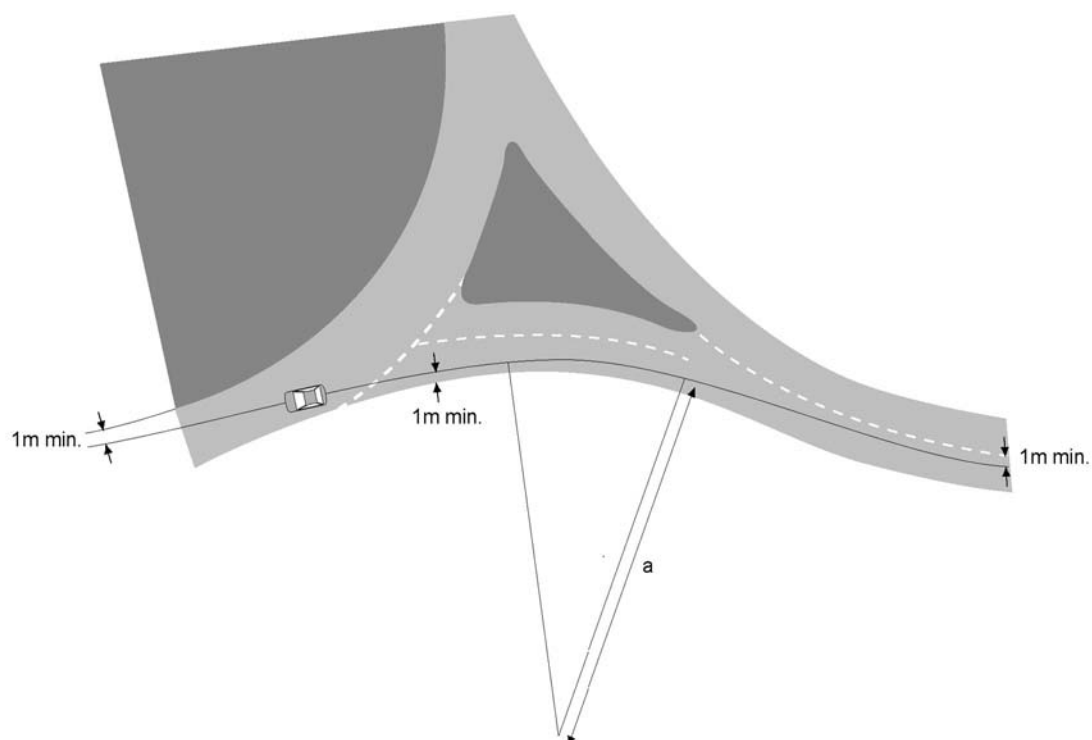

- a Entry path radius should be measured over the smallest best fit circular curve over a distance of 25m occurring along the approach entry path in the vicinity of the give way line, but not more than 50m in advance of it.
- b Commencement point 50m in advance of the give way line and at least 1m from nearside kerb or centre line

Figure 7/13: Determination of Entry Path Radius for the Left Turn where the Approach Curves to the Right

7.58 A method for creating entry deflection at a Normal Roundabout is to stagger the arms as shown in Figure 7/15. This will:

- reduce the size of the roundabout;
- minimise land acquisition;
- help to provide a clear exit route with sufficient width to avoid conflicts.

7.59 Sharp curves on the approach road should not be introduced to increase entry deflection, although a gentle curve to the right preceding left hand entry deflection may be used.

7.60 Approach curvature should follow the requirements on horizontal radii in **TD 9 (DMRB 6.1.1)**. Tight radii will require verge widening to provide adequate forward visibility and will add to the verge maintenance requirements (see **TD 51, DMRB 6.3.5**).

Exit Width

7.61 The exit width is the width of the carriageway on the exit and is measured in a similar manner to the entry width. It is the distance between the nearside kerb and the exit median (or the edge of any splitter island or central reserve) where it intersects with the outer edge of the circulatory carriageway. As with entry width, it is

measured normal to the nearside kerb. Values are typically similar to or slightly less than entry widths (exits have less flaring). With the exception of Compact Roundabouts, the exit width should, where possible, accommodate one more traffic lane than is present on the link downstream.

7.62 For example, at a Normal Roundabout, if the downstream link is a single carriageway road with a long splitter island, the exit width should be between 7m and 7.5m and the exit should taper down to a minimum of 6m (see Figure 7/16), allowing traffic to pass a broken down vehicle. If the link is an all-purpose two-lane dual carriageway, the exit width should be between 10m and 11m and the exit should taper down to two lanes wide.

7.63 The width should be reduced in such a way as to avoid exiting vehicles encroaching onto the opposing lane at the end of the splitter island. Normally the width would reduce at a taper of 1:15 to 1:20. Where the exit is on an up gradient, the exit width may be maintained for a short distance before tapering in. This helps reduce intermittent congestion caused by slowly accelerating large goods vehicles by giving other drivers an opportunity to overtake them. If the exit road is on an up gradient combined with an alignment which bends to the left, it may be necessary to maintain the exit width over a longer distance to help ensure that overtaking manoeuvres can be completed before the merge is encountered.

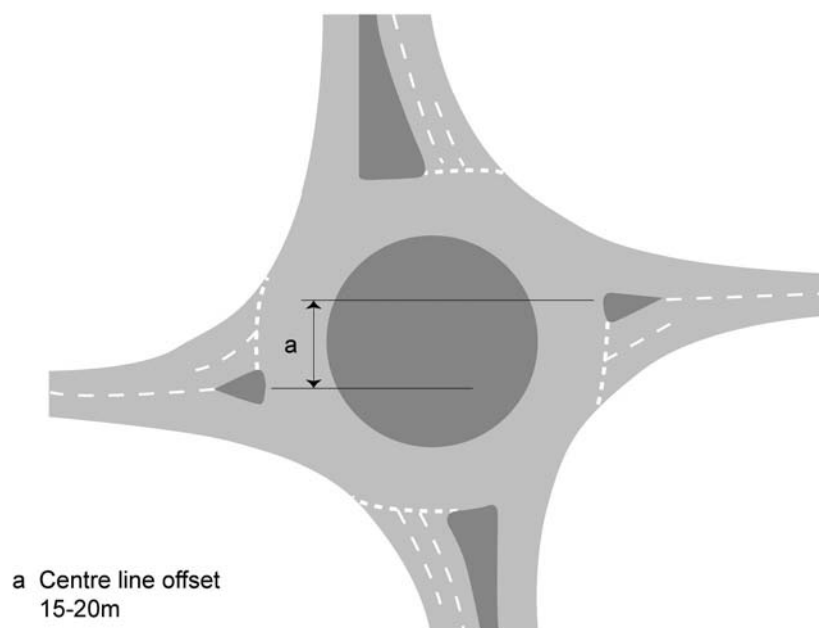

Figure 7/15: Staggering of East-West Arms to Increase Deflection

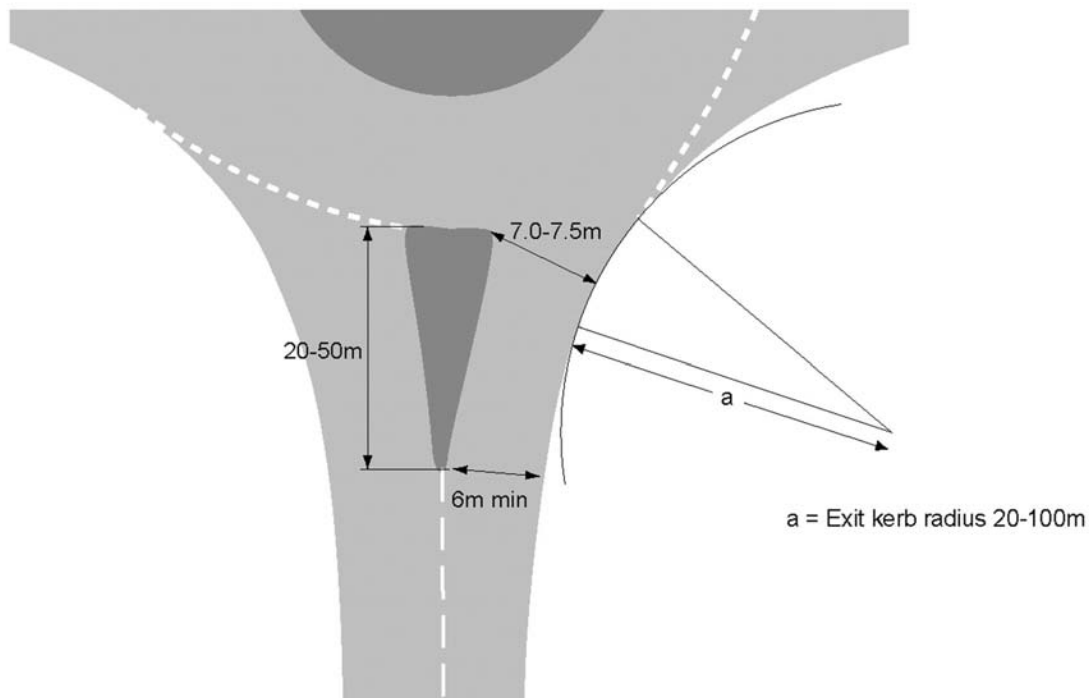

Figure 7/16: Typical Single Carriageway Exit at a Normal Roundabout with a Long Splitter Island

7.64 At a Compact Roundabout, the exit width should be similar to the entry width.

7.65 On exits, the edge line should continue along the projected line of the kerbing once this is terminated (see Figures 8/10 and 8/11 in Chapter 8).

Exit Kerb Radius

7.66 The exit kerb radius is shown in Figure 7/16 and is the exit equivalent of the entry kerb radius. Values for the exit kerb radius should exceed the largest entry radius (except at Compact Roundabouts, where they should be equal).

7.67 At a Compact Roundabout, the value of the exit kerb radius should lie between 15m and 20m.

7.68 At other roundabouts, the exit kerb radius should not be less than 20m or greater than 100m. A value of 40m is desirable, but for larger roundabouts on high speed roads, a higher value may suit the overall junction geometry. A compound curve starting with a 40m radius and developing to a larger radius, of up to 100m, will usually offer the best solution. Larger values of exit radii may lead to high exit speed, which will not be appropriate if there are significant numbers of cyclists using the junction or where pedestrian crossing facilities are located immediately downstream.

7.69 The shortest distance possible between an entry arm and the next exit is governed by the minimum entry radius (10m) and the minimum exit radius for the type of roundabout in question (15m at a Compact Roundabout, otherwise 20m).

7.70 If a roundabout is to be modified to include an additional arm, care should be taken to ensure that this does not affect safety at the preceding entry and following exit. It may be necessary to redesign the whole junction if adequate spacing and deflection between entries and adjacent exits cannot be achieved.

7.71 Exits should be checked to ensure that vehicle paths are smooth and vehicles are not directed towards splitter islands. Splitter islands should end at a tangent (or, at least, parallel) to the centre line and be long enough to prevent an exiting vehicle from crossing the centre line into oncoming traffic.

7.72 If the peak exit volume approaches the capacity of the downstream link, tapers longer than 1:20 may be needed to merge the traffic as the traffic density in each lane will be high.

7.73 Sharp turns into exits can increase the likelihood of load shedding by large goods vehicles and decrease the traffic capacity of the junction.

8. OTHER ASPECTS OF DESIGN

Visibility

8.1 Except for visibility to the right at entry (paragraph 8.7) and across the central island (paragraph 8.9), visibility must be obtainable from a driver's eye height of between 1.05m and 2m to an object height of between 0.26m and 2m, in accordance with the envelope of visibility for measurement of stopping sight distance in **TD 9 (DMRB 6.1.1)**.

8.2 Where signs are to be erected on a central reserve, verge or splitter island within the envelope of visibility, including to the right, the mounting height must not be less than 2m above the carriageway surface.

Forward Visibility on Approach (Stopping Sight Distance)

8.3 Visibility on the approach (Desirable Minimum Stopping Sight Distance for the design speed of the road) must conform to TD 9 (DMRB 6.1.1) with the position of the object at the give way line indicated in Figure 8/1. Chevron signs on the central island must also be visible to approaching drivers in all lanes from a distance equal to the Desirable Minimum Stopping Sight Distance. Chevron signs should not be stacked. If conspicuity of the signs is a problem, yellow backing boards or larger signs should be used. If the approach to the roundabout is over a crest, a higher mounting height may be used. See **Traffic Signs Manual Chapter 4**.

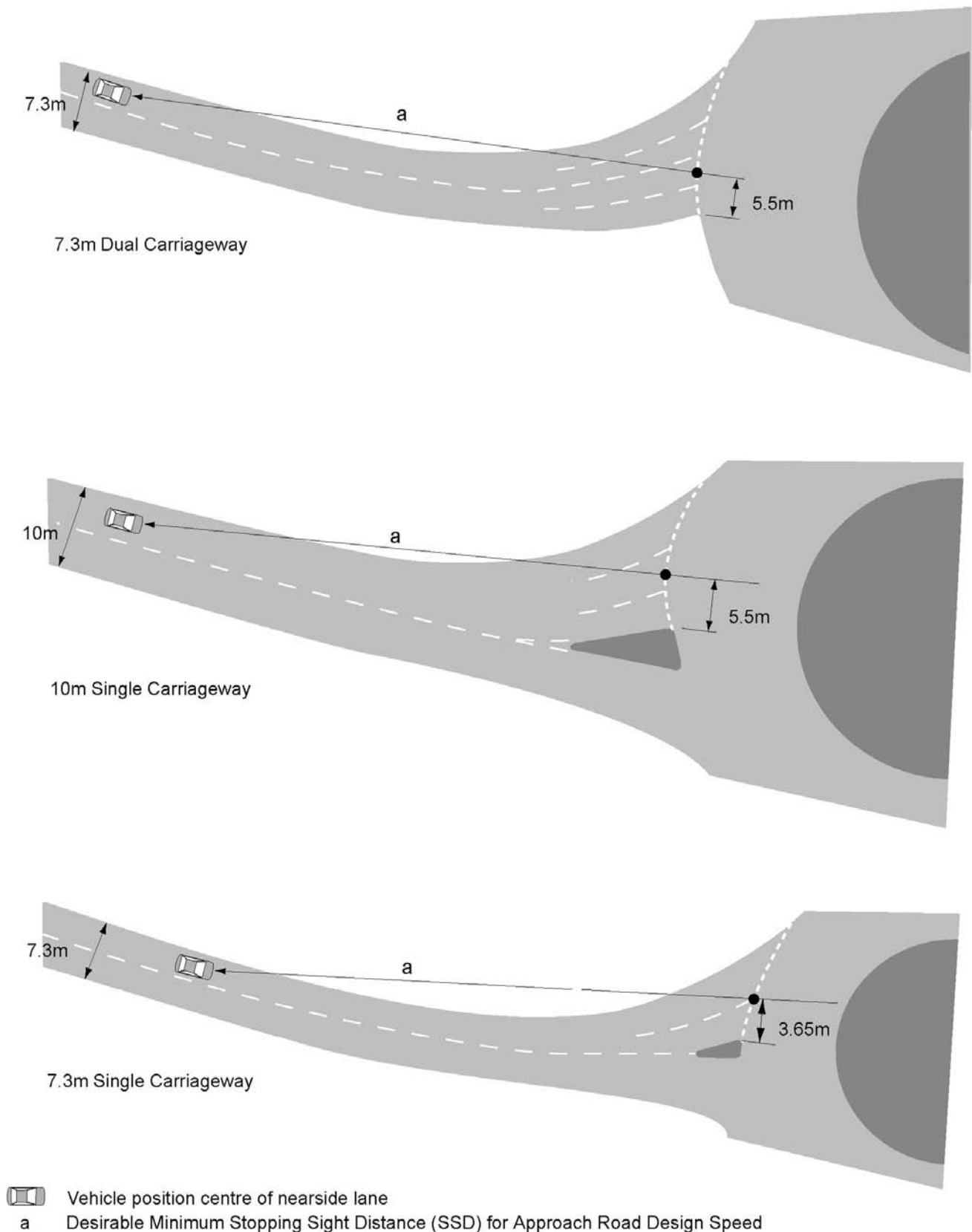

Figure 8/1: Measurement of Stopping Sight Distance on Curved Approach

Forward Visibility at Entry

8.4 Drivers of all vehicles approaching the give way line must be able to see objects of height between 0.26m and 2m on the full width of the circulatory carriageway for the Visibility Distance given in Table 8/1 (measured along the centre of the circulatory carriageway as shown in Figure 8/2). The visibility must be checked from the centre of the nearside lane at a distance of 15m back from the give way line, as shown in Figure 8/2.

Visibility to the Right

8.5 Drivers of all vehicles approaching the give way line must be able to see the full width of the circulatory carriageway to their right, from the centre of the offside lane at the give way line, for the Visibility Distance given in Table 8/1 (measured along the centre of the circulatory carriageway), as shown in Figure 8/3. This includes Grade Separated Roundabouts with bridge parapets on either side of the circulatory carriageway.

8.6 Visibility to the right must also be checked from the centre of the offside lane at a distance of 15m back from the give way line, as shown in Figure 8/4.

8.7 The envelope of visibility must be obtainable from a driver's eye height of between 1.05m and 2m to an object height of between 1.05m and 2m.

Table 8/1

Inscribed Circle Diameter (m)	Visibility Distance (m) ('a' in Figures)
<40	Whole junction
40 – 60	40
60 – 100	50
>100	70

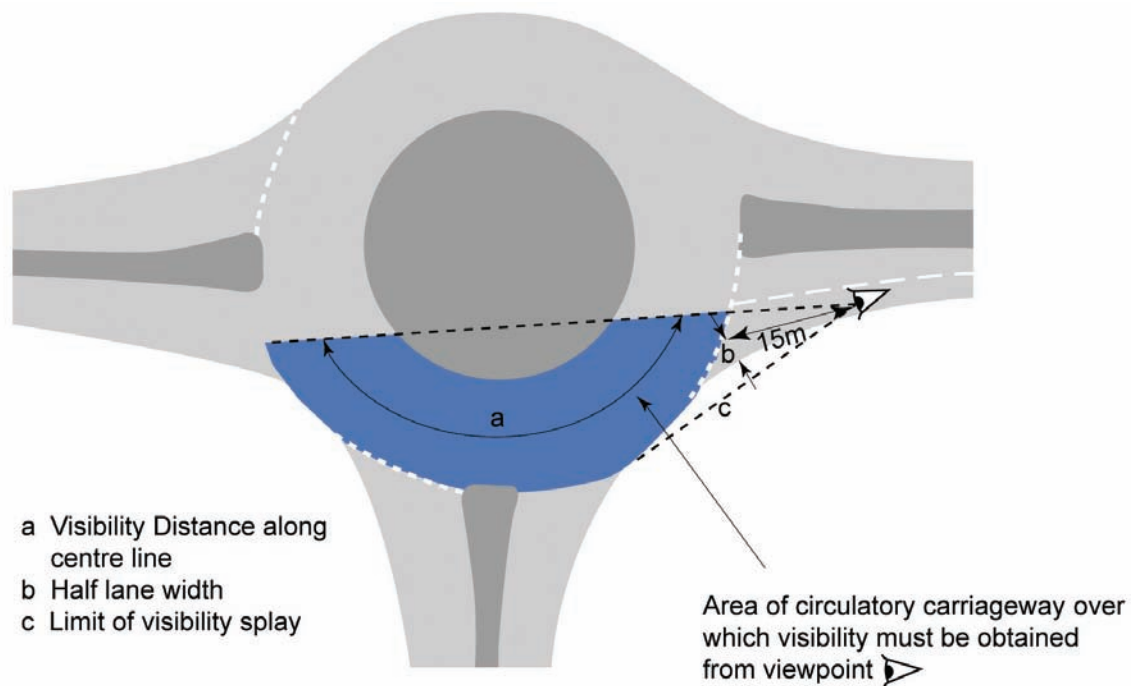

Figure 8/2: Forward Visibility Required at Entry

8.8 Excessive visibility to the right can result in high entry speeds, potentially leading to accidents. On dual carriageway approaches where the speed limit is greater than 40mph, limiting visibility to the right by screening until the vehicle is within 15 metres of the give way line

can be helpful in reducing excessive approach speeds. The screening should be at least 2m high, in order to block the view of all road users. Screening can also be used on flared approaches on high speed single-carriageway roads where there is a long splitter island.

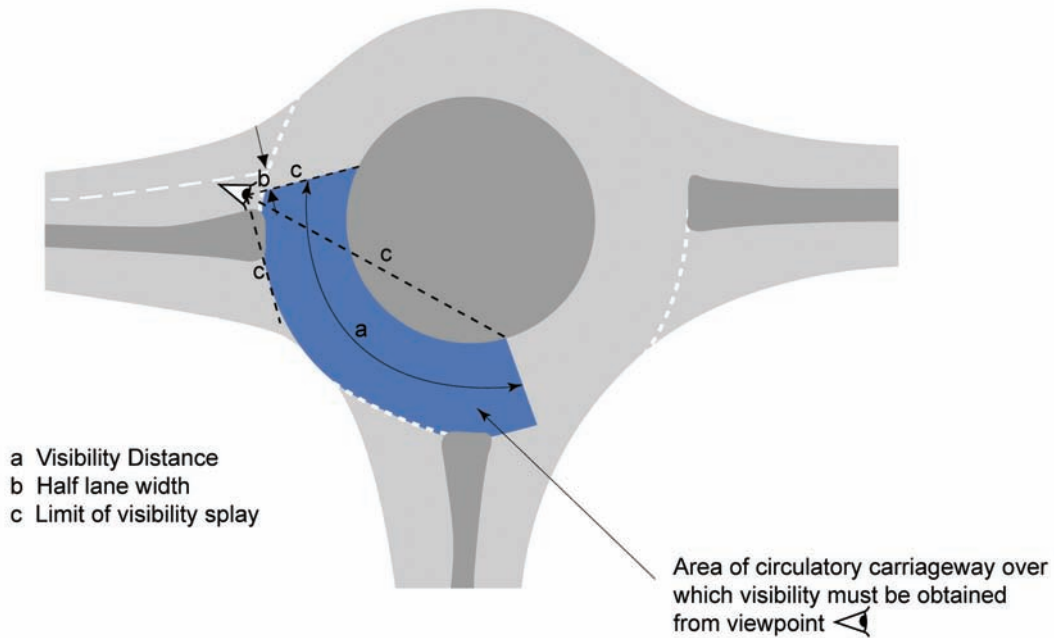

Figure 8/3: Visibility to Right Along Circulatory Carriageway Required at Entry (from Give Way Line)

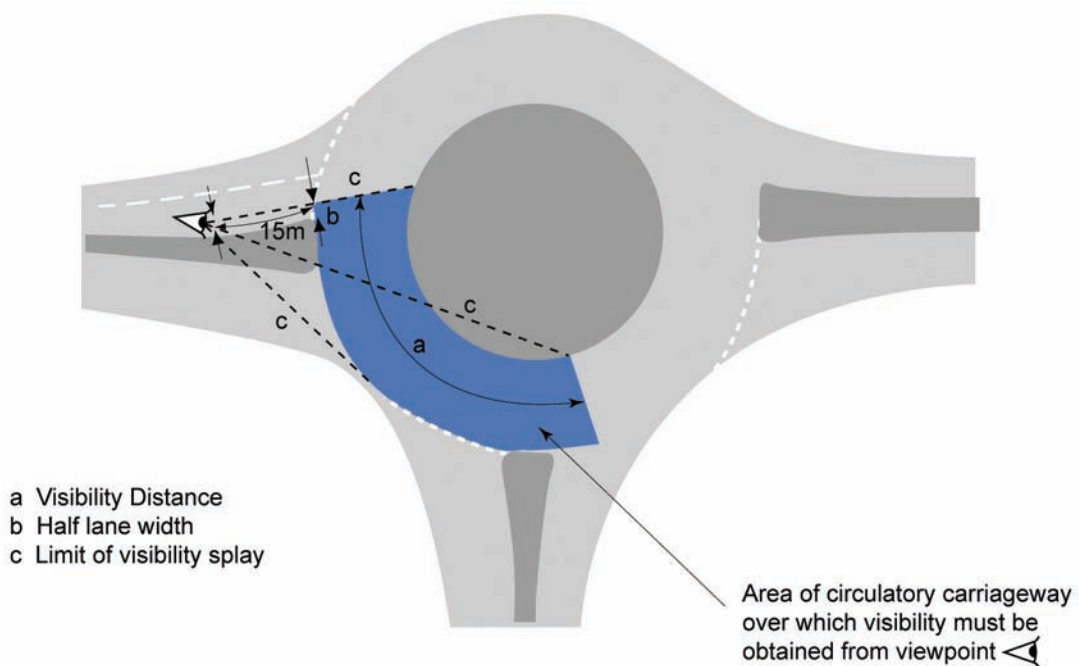

Figure 8/4: Visibility to Right Along Circulatory Carriageway Required at 15m in Advance of Give Way Line

Circulatory Visibility

8.9 Drivers on the circulatory carriageway must be able to see the full width of the circulatory carriageway ahead of them for the Visibility Distance given in Table 8/1. This visibility must be checked at a distance of 2m in from the central island, as shown in Figure 8/5. The envelope of visibility must be obtainable from a driver's eye height of between 1.05m and 2m to an object height of between 1.05m and 2m.

8.10 It is often useful to improve the conspicuity of central islands by landscaping, but the circulatory visibility needs to be checked to ensure it is not obstructed. Normally, at least the outer 2m of the central island should be hard standing or planted with grass or similar low level vegetation.

Pedestrian Crossing Visibility

8.11 Drivers approaching a roundabout with a Zebra crossing across the entry must be able to see the full width of the crossing so that they can see whether there are pedestrians wishing to cross. For a signal-controlled crossing, the driver must also be able to see at least one signal head. The visibility required is the Desirable Minimum Stopping Sight Distance for the design speed of the link. See **TD 9 (DMRB 6.1.1)** and **Local Transport Note LTN 2/95**.

8.12 At the give way line, drivers must be able to see the full width of a pedestrian crossing (whether signal-controlled, zebra or informal) across the next exit if it is within 20m of the give way line on that arm (crossings should not be sited between 20m and 60m from the give way line). See Figure 8/6.

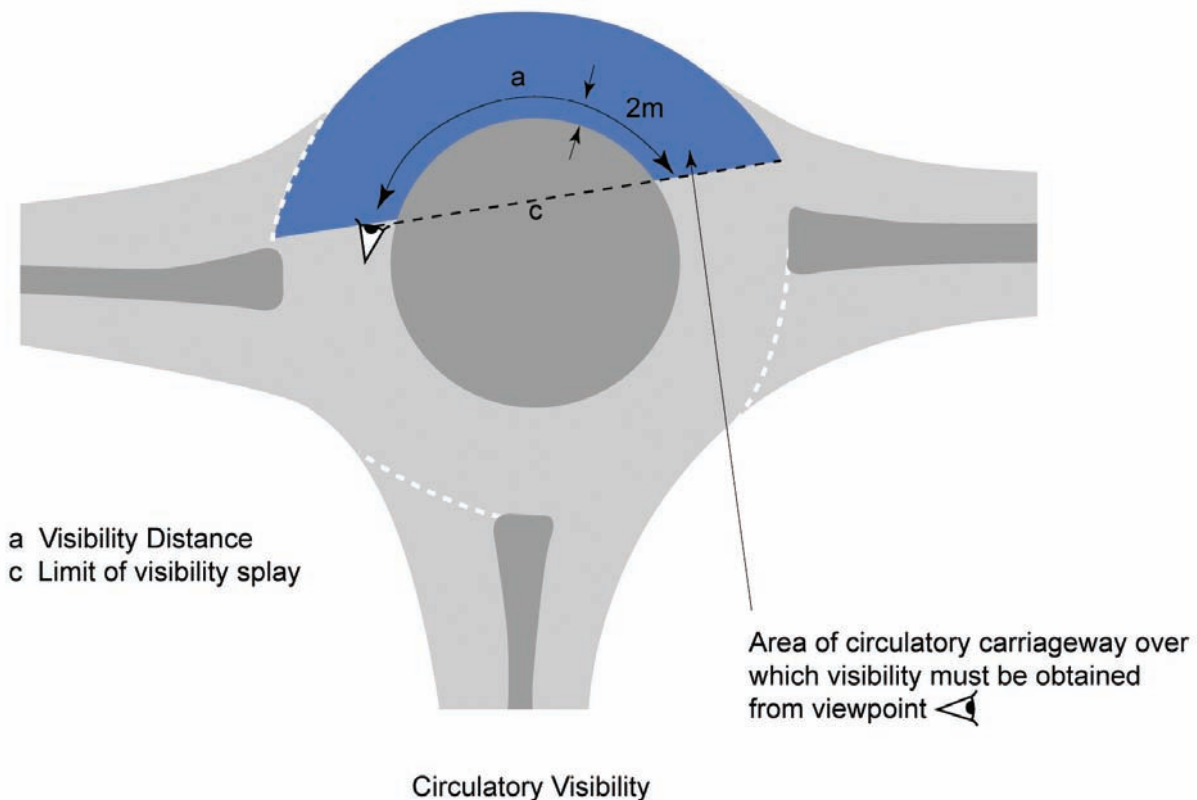

Figure 8/5: Circulatory Visibility Required

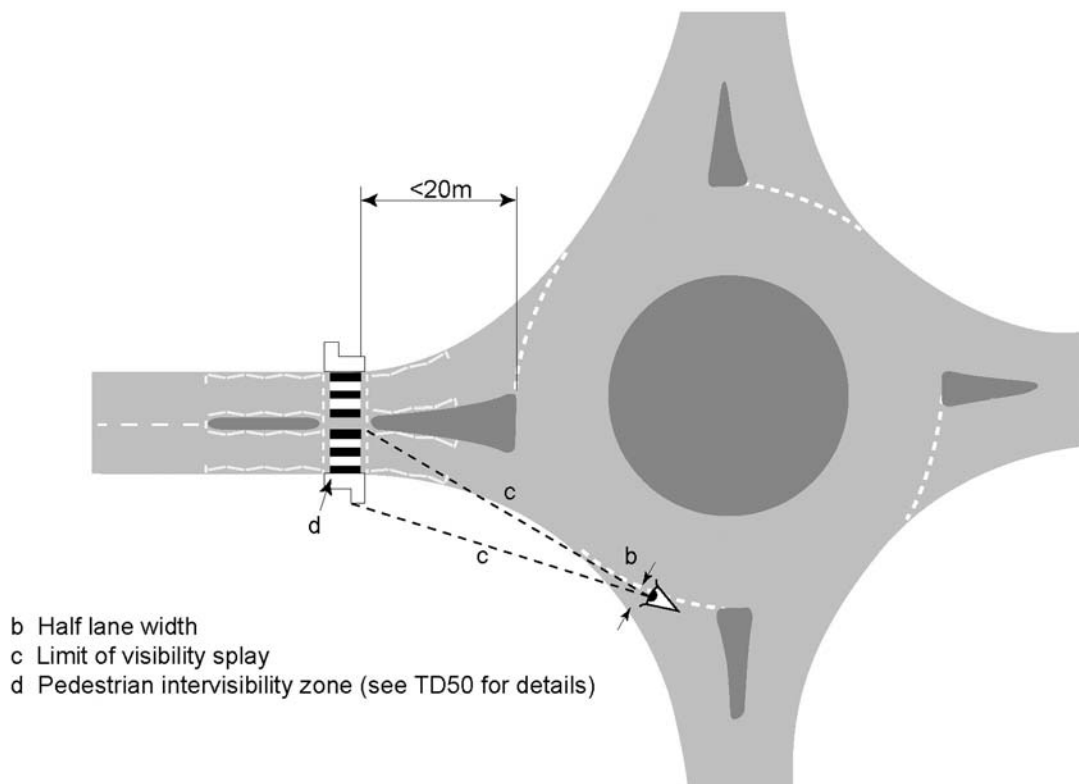

Figure 8/6: Visibility Required at Entry to Pedestrian Crossing at Next Exit

Exit Visibility

8.13 On the circulatory carriageway, the exit visibility should conform to Table 8/1. Once a vehicle has crossed the inscribed circle at the exit from the roundabout, the Stopping Sight Distance should conform to **TD 9 (DMRB 6.1.1)**.

Visual Intrusions

8.14 Signs, street furniture and planting should be located and designed so as not to obstruct visibility. However, isolated objects less than 550mm wide such as lamp columns, sign supports or bridge columns are acceptable.

Visibility at Grade Separated Junctions

8.15 At Grade Separated Roundabouts in particular, care is needed to ensure that the give way line is clearly visible to approaching drivers. This can be achieved by the provision of a short length, say 10m, of level approach road immediately prior to the give way line (subject to the requirements for minimum crossfall and

longitudinal gradient for drainage set out in **TD 9, DMRB 6.1.1**).

Crossfall and Longitudinal Gradient

8.16 Steep gradients should be avoided at roundabout approaches or flattened to a maximum of 2% before entry. Crossfall and longitudinal gradient combine to provide the necessary slope to drain surface water from the carriageway. Although the following paragraphs are written in terms of crossfall for simplicity, the value and direction of the greatest slope should always be taken into account when considering drainage.

8.17 On the approaches and exits, superelevation can assist drivers in negotiating the associated curves. Its value, when used, should be appropriate to the speed of vehicles, and equal to or greater than those necessary for surface drainage, but should not exceed 5% (1 in 20). Superelevation should be reduced to 2% at 20m from the give way line, since with adequate advance signing and entry deflection, speeds on approaches should be reducing.

Crossfall on the Circulatory Carriageway

8.18 Except on large Grade Separated Roundabouts (where long sections of circulatory carriageway should have appropriate superelevation), crossfall is required to drain surface water on circulatory carriageways. The normal value is 2% (1 in 50). It should not exceed 2.5% (1 in 40). To avoid ponding, longitudinal edge profiles should be graded at not less than 0.67% (1 in 150), with 0.5% (1 in 200) considered the minimum. The design gradients do not in themselves ensure satisfactory

drainage, and, therefore, the correct siting and spacing of gullies is critical.

8.19 At Normal Roundabouts on high speed roads, it is good practice to arrange for crossfall to assist vehicles. To do this, a crown line is formed. This line can either join the ends of the splitter islands as shown in Figure 8/7, or divide the circulatory carriageway in the proportion 2:1 internal to external (Figure 8/8). In some cases a subsidiary crown line may assist in achieving appropriate values of crossfall without giving excessive changes at the main crown line (Figure 8/9).

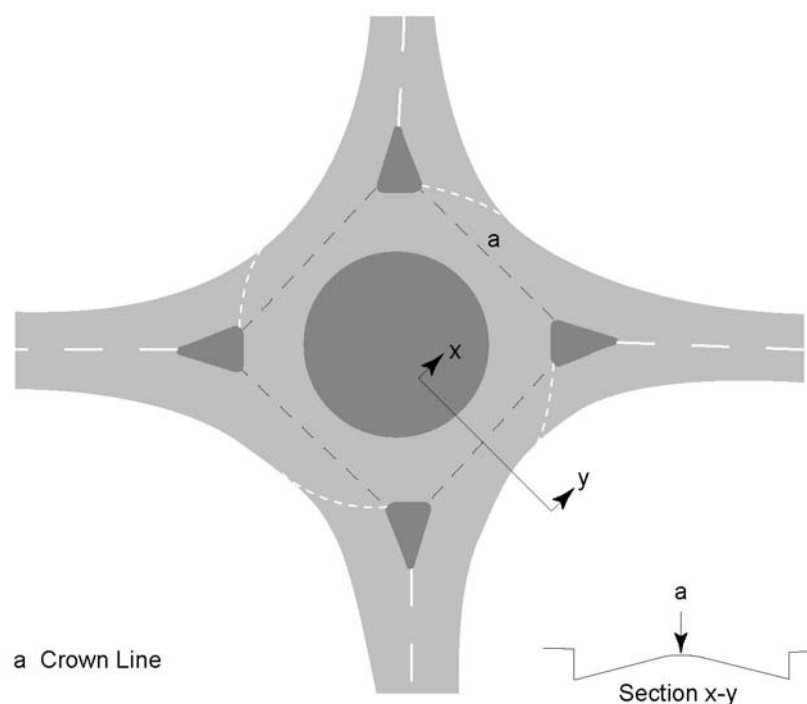

Figure 8/7: Using One Crown Line to Join Splitter Islands

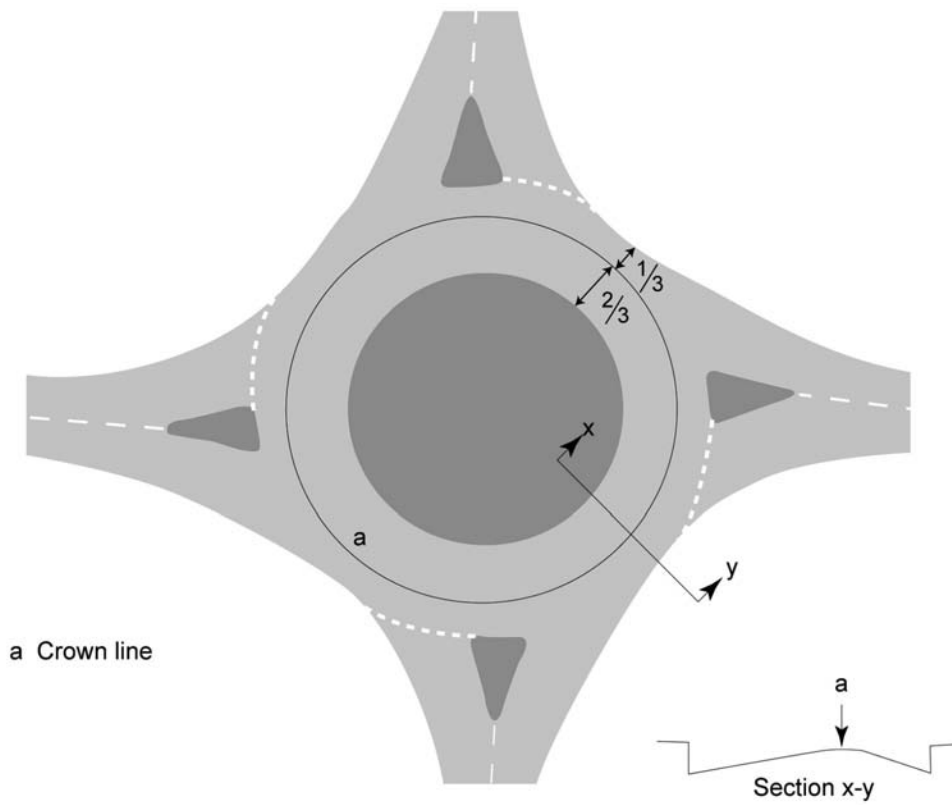

Figure 8/8: Using One Crown Line to Divide the Carriageway in the Ratio 2:1

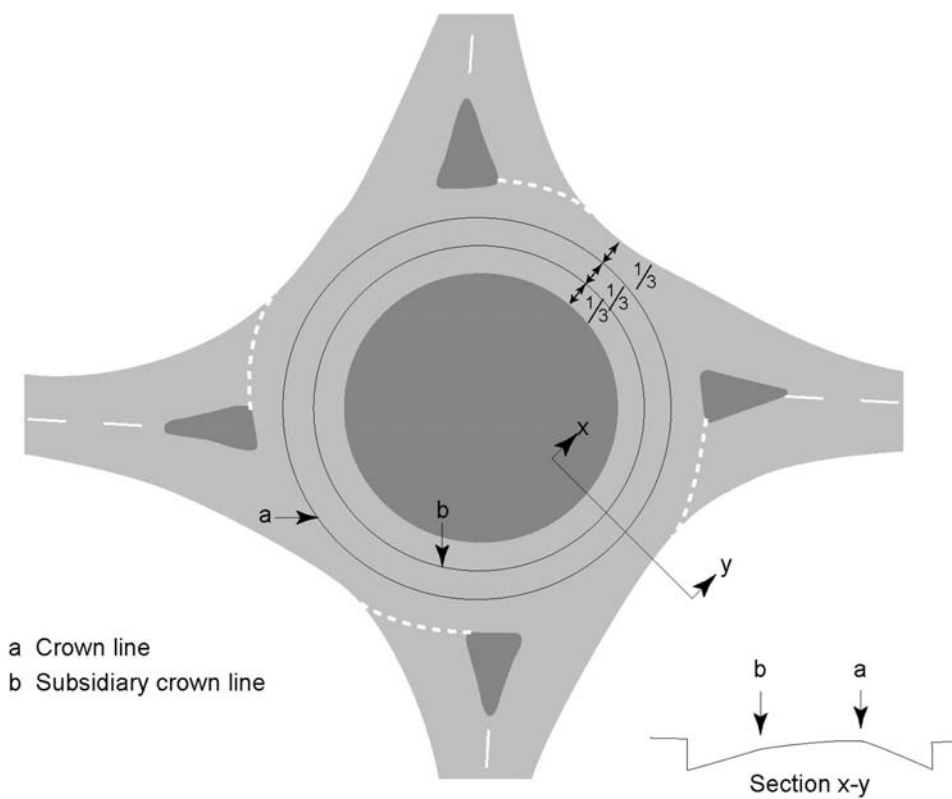

Figure 8/9: Using Two Crown Lines

8.20 The conflicting crossfalls at the crown lines have a direct effect on driver comfort and may also be a contributory factor in load shedding and large goods vehicle roll-over accidents. Over a given section, the maximum recommended arithmetic difference in crossfall is 5%. Lower values are desirable, particularly for roundabouts with a small inscribed circle diameter. There should be no sharp changes in crossfall and a smooth crown is essential.

8.21 At Compact Roundabouts and small Normal Roundabouts, it is more appropriate to apply constant crossfall in one direction across the full width of the circulatory carriageway. At roundabouts where the speed limit within 100m from the give way line does not exceed 40mph on any approach, this crossfall can slope outwards to ease drainage and help keep speeds down. It also makes the central island more conspicuous.

Crossfall at Exits

8.22 At exits, superelevation should be provided where necessary to allow vehicles to accelerate safely away from the roundabout. However, as with entries, crossfall adjacent to the roundabout should not exceed 2%. If the exit leads into a right hand curve, superelevation should be introduced gradually.

Lighting

8.23 In Northern Ireland, Wales and Scotland, road lighting must be provided at roundabouts.

8.24 In England, the provision of road lighting at roundabouts must be considered in accordance with **DMRB 8.3**.

Road Marking and Signing

8.25 Guidance on the appropriate use of road markings at various types of roundabout is contained in Section 8 of **Chapter 5** of the **Traffic Signs Manual**. A well-designed Normal Roundabout with balanced traffic movements will operate effectively under the marking schemes shown in Figure 8.1 of the **Traffic Signs Manual Chapter 5**. However roundabouts with high flows and inscribed circle diameters close to the recommended maximum and Grade Separated Roundabouts with large inscribed circle diameters will need additional markings and signs on the approaches and circulatory carriageway. **TA 78 (DMRB 6.2.3)** gives advice on their design.

8.26 Road markings are used to channelise traffic and, where required, to indicate a dedicated lane. Lane direction signs complementing the advance direction signs at entries can be beneficial where heavy flows occur in a particular direction.

8.27 Where any particular lane is dedicated, the other lanes should also have arrow markings. This arrangement should always be accompanied by direction signing to indicate lane dedication.

8.28 The use of right pointing arrows on lane dedication signs or as markings on the road is not permitted on roundabout approaches (except at mini-roundabouts). This is to avoid confusing drivers, particularly those from overseas, over which way to proceed around the roundabout. Where a right hand lane is dedicated to a specific destination, it should be associated with an ahead arrow on the approach. A right pointing arrow may be used on the circulatory carriageway.

8.29 Left turn arrows should only be used with caution on the circulatory carriageway, to avoid drivers mistakenly turning into roundabout entries.

8.30 **Chapter 4** of the **Traffic Signs Manual** (Sections 2, 3 and 5) provides guidance on the warning signs to be used at roundabouts. Directional signs for use at roundabouts are prescribed in the **Traffic Signs Regulations and General Directions (TSRGD)**. Guidance on the design of directional traffic signs is given in **Local Transport Note LTN 1/94** and **Chapter 7** of the **Traffic Signs Manual**. Where additional road markings are used to designate lanes on the approaches and circulatory carriageways, complementary signs to **TSRGD** Diagram 2019 or 2114 (non-motorways) and Diagram 2913.3 (motorways) are recommended. On wide approaches or circulatory carriageway where tall vehicles could obscure post mounted signs, gantry mounted signs to Diagram 2021.1 or 2114.1 (non-Motorways) or 2913.4 (Motorways) are recommended.

8.31 Passively safe signposts and signal posts may be appropriate at roundabouts on high speed roads where there is not enough room for full safety barrier provision. The use of passively safe chevron signs to Diagram 515.1 of the **TSRGD** should also be considered. See **TA 89 (DMRB 8.2.2)**.

8.32 In urban areas, a sloping ring of block paving laid in a black and white chevron pattern around the central island can improve its conspicuity. See **TSRGD**

Diagram 515.2. Details and further guidance on its use can be found in the **Traffic Signs Manual Chapter 4**. Regular maintenance inspections of this type of treatment are required as weather conditions can fade this type of blockwork. Normal chevron signs should be included.

8.33 Chevron signs can impinge on circulatory visibility but the effects can be minimised by positioning the signs 2m back from the central island kerbline (see paragraphs 3.12 to 3.22 of **Chapter 4** of the **Traffic Signs Manual** for advice).

Segregated Left Turn Lanes

8.34 The use of segregated left turn lanes is covered in **TD 51 (DMRB 6.3.5)**.

Skidding Resistance

8.35 For information on skidding resistance on the approaches to roundabouts and the circulatory carriageway, refer to **HD 28 (DMRB 7.3.1)**. **HD 36 (DMRB 7.5.1)** gives advice on appropriate surfacing materials giving the required skid resistance properties. The provision of high friction surfacing should be considered on the immediate approaches and circulatory carriageway for roundabouts on roads with high approach speeds.

8.36 Materials with appropriate skid resistance must be used for road markings at roundabouts. Details of the requirements for these are given in Clause 1212 of **MCHW 1**.

Landscaping

8.37 The design of landscaping within the highway limits must be carried out in consultation with appropriate specialists. The designer must develop clear objectives for the design and must consider the long-term maintenance implications of the scheme. Where the responsibility for maintenance is passed to a third party, such as a local council, maintenance standards must be agreed. If a third party wishes to enhance the standard of planting or landscaping at roundabouts, for example, using special floral displays, this must only be with the agreement of the Overseeing Organisation, and must not compromise visibility or safety. Further advice is given in **DMRB Volume 10**.

8.38 Apart from the amenity benefits, the landscape treatment of roundabouts can have practical advantages from a traffic engineering point of view by making the presence of the roundabout more obvious to approaching traffic. Planting on the central reserve or splitter island within 15m of the give way line is generally discouraged although the screening of traffic on the opposite side of the roundabout to the point of entry can, without restricting necessary visibility, avoid distraction and confusion caused by traffic movements of no concern to a driver. Planting can provide a positive background to chevron signs on the central island while visually uniting the various vertical features and reducing any appearance of clutter.

8.39 The areas required for visibility envelopes should be either hard surface or planted with grass or species having a low mature height and low maintenance characteristics. Higher and denser species of shrubs and coppiced trees, without thick trunks, can be planted towards the centre of the island. Planting of an ornamental nature, which might be more appropriate in an urban area, generally requires greater maintenance if it is to be successful. Any planting should have bulk and substance in winter as well as during the summer months.

8.40 In rural areas, planting should generally be restricted to indigenous species and be related to the surrounding landscape, although the final choice of species also depends on the particular objectives of the scheme. In open moorland, for example, tree and shrub planting would appear incongruous with the surroundings and landscape treatment would normally be restricted to localised ground modelling and planting or seeding of low-growing moorland-type vegetation to reflect the local characteristics. If trees are proposed, leaf mulch on the carriageway should be avoided by careful choice of species and by locating the planting away from the roundabout edge.

8.41 Planting on a central island of less than 10 metres diameter is not generally appropriate due to the visibility requirements. As the size of the island increases, the visibility splays for drivers approaching and negotiating the roundabout leave a greater area available for landscaping.

8.42 In order to minimise the consequences of accidents in which a vehicle runs off the road, solid obstructions such as statues, trees or rocks should not be placed on the central islands of roundabouts with high speed approaches, or anywhere within the highway boundary where there is a high risk of collision.

Vehicle Restraint Systems

8.43 The need for a vehicle restraint system should be considered in accordance with **TD 19 (DMRB 2.2.8)**.

8.44 At Grade Separated Roundabouts, where there is a possibility of an errant vehicle reaching the road below, a risk assessment should be undertaken to evaluate this possibility and the consequent need for mitigation measures, for example a vehicle restraint.

Kerbing and Verge Width

8.45 Roundabout entries and exits should be kerbed, and hard strips or hard shoulders on each approach should terminate where entry widening begins. The simplest procedure is to start the kerbs on the approach at the back of the hardstrip and then terminate the hard strip edge line in a short smooth curve or taper (see

Figures 8/10 and 8/11). On the exit, the kerbing can terminate where the hard strip starts.

8.46 The verge width should be at least 2.5m and should generally be consistent around the roundabout. Further advice is given in **TD 27 (DMRB 6.3.2)**. Factors that should be taken into account in determining verge width include:

- visibility requirements (paragraphs 8.1 to 8.16);
- needs of Non-Motorised Users (see **TA 90** and **TA 91, DMRB 5.2.4**);
- space required to accommodate buried services, road signs and other street furniture;
- maintenance access (see paragraph 1.18);
- any likely future traffic increases that could require an increase in carriageway width.

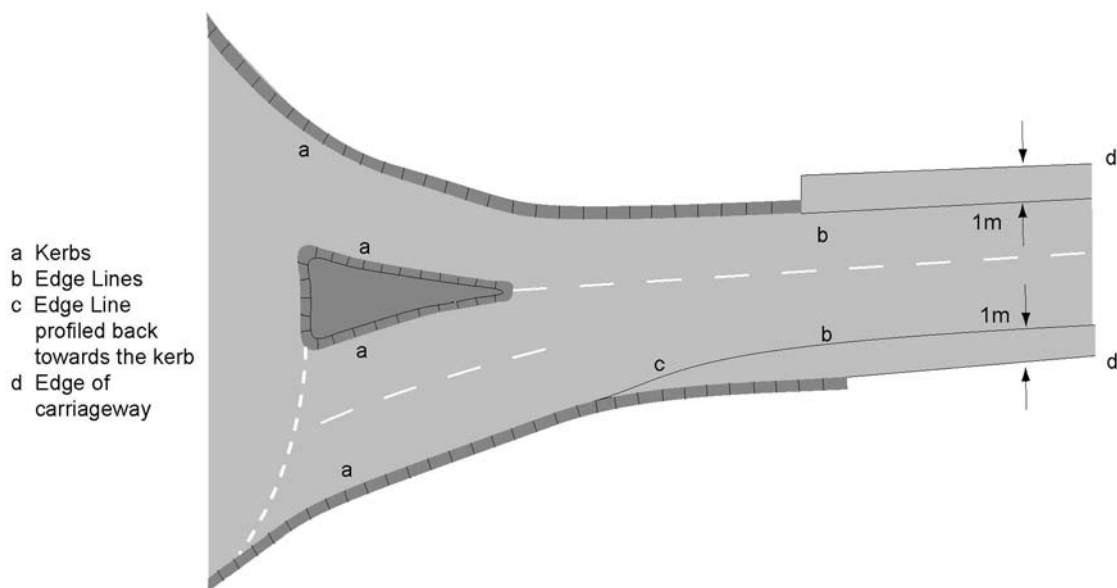

Figure 8/10: Method of Terminating Edge Strips on a Single Carriageway Approach to a Roundabout

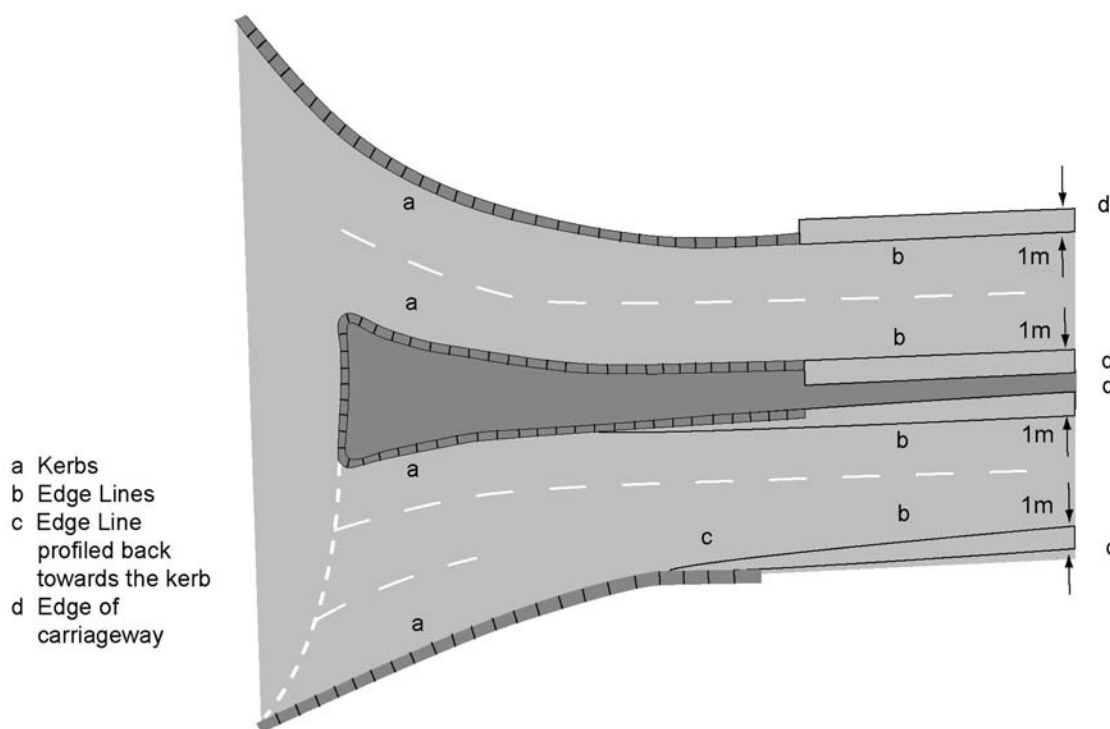

Figure 8/11: Method of Terminating Edge Strips on a Dual Carriageway Approach to a Roundabout

8.47 At dual carriageway and grade separated junctions, there is a need to consider the possibility of vehicles exiting a motorway or dual carriageway road via the on-slip during major incidents and under Police direction. These vehicles will need to proceed around the roundabout in the normal direction. In order to cover this eventuality for large vehicles, an area of hard standing may be used either side of the exit arm as appropriate, or possibly on the central island. The optimum arrangement will be site specific and should be checked using swept paths, whilst ensuring that the layout is safe and does not confuse road users during normal day to day operation. The designer should check with the Overseeing Organisation's staff responsible for incident planning to ensure that these issues are considered.

Improvement Measures at Existing Roundabouts

8.48 When considering improvements to roundabouts, an accident investigation should be undertaken and the improvements developed with advice from a specialist road safety engineer. Levels of skidding resistance on the approaches and the circulatory carriageways should be checked.

8.49 On roundabouts where flow patterns have changed since design, road markings may help to:

- improve throughput at high levels of traffic flow;
- cater for particularly high turning movements;
- smooth the flow at roundabouts with irregular geometry;
- improve safety.

Spiral markings in particular can improve lane discipline on the circulatory carriageway. Designation of lanes on the approach can also help. Further guidance is given in **TA 78 (DMRB 6.2.3)**.

8.50 If, as part of an improvement scheme, changes are proposed to lane assignments on a roundabout approach and circulatory carriageway, the designer must review the safety and capacity of the overall roundabout layout, including analysis of swept paths through entries and around the central island.

8.51 The provision of Transverse Yellow Bar Markings on high speed dual carriageway approaches can reduce rear shunt and overshoot accidents by helping to alert the driver to the presence of the roundabout (see **Traffic Signs Manual Chapter 5**, section 11, and **TRL Report LR1010**). Their use may be considered where the conditions given in **Traffic Signs Manual Chapter 5** are met. On high speed single carriageway roads on which drivers fail to adjust their speed in time to negotiate the roundabout safely or, if necessary, stop, the provision of 'Reduce Speed Now' signs to Diagram 511 of the **TSRGD** can have a similar effect (see **Traffic Signs Manual Chapter 4**).

8.52 The following can all help to reduce accidents at roundabouts, although the overprovision of signs should be avoided:

- repositioning and/or repeating (e.g. nearside and offside) of warning signs;
- on high speed dual carriageways, providing additional map type direction signs at ½ mile in advance of the roundabout;
- making the give way line more conspicuous;
- extending the central island chevron sign further to the left to emphasise the angle of turn;
- on dual carriageway roads, placing additional chevron signs in the central reserve in line with the offside lane approach.

8.53 The reduction of excessive entry width by extending the splitter island can reduce accidents at some roundabouts with poor safety records. This should be achieved by physical means wherever possible.

8.54 Where inadequate entry deflection is leading to operational and safety problems and it is not possible to improve deflection by increasing the size of the central island and/or extending the splitter islands, subsidiary deflection islands may be used (see **TD 51**, **DMRB 6.3.5**). Alternatively, it may be possible to signalise the roundabout.

8.55 Accident problems resulting from high circulatory speeds on large roundabouts may indicate that a Signalised Roundabout is required.

8.56 If entry problems are caused by poor visibility to the right, good results may be achieved by extending the splitter island to narrow the circulatory carriageway and moving the give way line forward.

8.57 Single vehicle, powered two-wheeler and overshoot accidents can be partly mitigated by good signing and marking, by limiting visibility to the right until 15m before entry using suitable screening, and by ensuring that the layout guides drivers around the central island.

8.58 Reverse curves (to the right and then to the left on the approach) can be effective in providing additional deflection on poorly aligned existing roundabouts, but sharp curves are not good practice and could induce large goods vehicle rollover or accidents involving powered two wheelers.

8.59 Various mitigation measures for the safety of particular road user types including powered two wheelers, large goods vehicles and non-motorised users are suggested in Chapter 5 of this Standard.

9. REFERENCES

DESIGN MANUAL FOR ROADS AND BRIDGES (DMRB)

- a) DMRB Volume 2 Highway Structures: Design (Substructures and Special Structures) Materials Section 2. Part 2. TD 19/06. Requirement for Road Restraint Systems.
- b) DMRB Volume 5 Assessment and Preparation of Road Schemes. Section 1. Part 4. TA 22/81. Vehicle Speed Measurement on All-Purpose Roads.
- c) DMRB Volume 5 Assessment and Preparation of Road Schemes. Section 2. Part 4. TA 91/05. Provision for Non-motorised Users.
- d) DMRB Volume 6 Road Geometry. Section 1 Links. Part 2. TD 9/93. Highway Link Design.
- e) DMRB Volume 6 Road Geometry. Section 2 Junctions. Part 3. TD 50/04. The Geometric Layout of Signal Controlled Junctions and Signalised Roundabouts.
- f) DMRB Volume 6 Road Geometry. Section 1 Links. Part 1. TD 27/05. Cross sections and Headrooms.
- g) DMRB Volume 6 Road Geometry. Section 2 Junctions. Part 3. Design of Road Markings at Roundabouts.
- h) DMRB Volume 6 Road Geometry. Section 2 Junctions. Part 3. TD 54/07. Mini-roundabouts.
- i) DMRB Volume 6 Road Geometry. Section 3. Part 5. TD 51/03. Segregated Left Turn Lanes and Subsidiary Deflection Islands at Roundabouts.
- j) DMRB Volume 6 Road Geometry. Section 3. Part 5. TA 90/05. The Geometric Design of Pedestrian, Cycle and Equestrian Routes.
- k) DMRB Volume 7 Pavement Design and Maintenance. Section 3. Part 1. HD 28/04. Skidding Resistance.
- l) DMRB Volume 7 Pavement Design and Maintenance. Section 5. Part 1. HD 36/99. Surfacing Materials for New and Maintenance Construction.
- m) DMRB Volume 8 Traffic Signs and Lighting. Section 1. Traffic signals and Control Equipment.
- n) DMRB Volume 8 Traffic Signs and Lighting. Section 2. Traffic signs and road markings. Part 2. TA 89/05. Use of Passively Safe Signposts, Lighting Columns and Traffic Signal Posts to BS EN 12767.
- o) DMRB Volume 8 Traffic Signs and Lighting. Section 3. Lighting.
- p) DMRB Volume 10 Environmental Design and Management.

DEPARTMENT FOR TRANSPORT

- a) Road Casualties Great Britain (The Casualty Report). The Stationery Office.
- b) Local Transport Note LTN 1/94 – The Design and Use of Directional Informatory Signs: The Stationery Office.
- c) Local Transport Note LTN 1/95 – The Assessment of Pedestrian Crossings: The Stationery Office.
- d) Local Transport Note LTN 2/95 – The Design of Pedestrian Crossings: The Stationery Office.
- e) Guidance on the Use of Tactile Paving Surfaces.
- f) Traffic Signs Manual. Chapters 4, 5 and 7.
- g) Traffic Advisory Leaflet TAL 1/02. The Installation of Puffin Pedestrian Crossings.
- h) Traffic Advisory Leaflet TAL 1/01. Puffin Pedestrian Crossing.
- i) Traffic Advisory Leaflet TAL 2/03. Signal-control at Junctions on High Speed Roads.
- j) Traffic Advisory Leaflet TAL 3/03. Equestrian Crossings.

- k) Traffic Advisory Leaflet TAL 5/05. Pedestrian Facilities and Signal Controlled Junctions.
- l) Traffic Advisory Leaflet TAL 12/93. Overrun areas.
- m) Traffic Signs Regulations and General Directions (2002). The Stationery Office.
- n) Highways (Traffic Calming) Regulations (1999). The Stationery Office.
- o) Inclusive Mobility: A Guide to Best Practice on Access to Pedestrian and Transport Infrastructure.
- p) The Zebra, Pelican and Puffin Pedestrian Crossing Regulations and General Directions.
- q) Vehicle Construction and Use Regulations.
- i) TRL Report TRL281. Accidents at Urban Mini-roundabouts.
- j) TRL Report LR942. The Traffic Capacity of Roundabouts.
- k) TRL Published Project Report PPR206. International comparison of roundabout design guidelines. Available on request from Overseeing Organisation.
- l) Layfield, R. and Maycock, G. (1986). Pedal cyclists at roundabouts. Traffic Engineering and Control 27(6). pp 343-9.

MISCELLANEOUS

- a) Brown, M. (1995). The Design of Roundabouts. TRL State-of-the-art Review. The Stationery Office, London.
- b) Hall, R.D. and Surl, R.A.J. (1981). Accidents at Four Arm Roundabouts and Dual Carriageway Intersections – some Preliminary Findings. Traffic Engineering and Control. Vol 22 (6), p339-44.
- c) IHIE Guidelines for Motorcycling – Improving Safety through Engineering and Integration. (April 2005).
- d) TRL Report LR788. Articulated Vehicle Roll Stability – Methods of Assessments and Effects of Vehicle Characteristics.
- e) TRL Report LR1010. Yellow Bar Experimental Carriageway Markings – Accident Study.
- f) TRL Report LR1120. Accidents at 4 Arm Roundabouts.
- g) TRL Report SR662. Goods Vehicle Manoeuvres: a Computer Simulation and its Application to Roundabout Design.
- h) TRL Report SR724. The Effects of Zebra Crossings on Junction Entry Capacities.

10. ENQUIRIES

All technical enquiries or comments on this Standard should be sent in writing as appropriate to:

Chief Highway Engineer
The Highways Agency
123 Buckingham Palace Road
London
SW1W 9HA

G CLARKE
Chief Highway Engineer

Director of Trunk Roads: Infrastructure and
Professional Services
Transport Scotland
Trunk Road Network Management
8th Floor, Buchanan House
58 Port Dundas Road
Glasgow
G4 0HF

A C McLAUGHLIN
Director of Trunk Roads: Infrastructure
and Professional Services

Chief Highway Engineer
Transport Wales
Welsh Assembly Government
Cathays Parks
Cardiff
CF10 3NQ

M J A PARKER
Chief Highway Engineer
Transport Wales

Director of Engineering
The Department for Regional Development
Roads Service
Clarence Court
10-18 Adelaide Street
Belfast BT2 8GB

R J M CAIRNS
Director of Engineering