



THE HIGHWAYS AGENCY

TD 42/95



THE SCOTTISH OFFICE DEVELOPMENT DEPARTMENT



THE WELSH OFFICE
Y SWYDDFA GYMREIG



THE DEPARTMENT OF THE ENVIRONMENT FOR
NORTHERN IRELAND

Geometric Design of Major/Minor Priority Junctions

Summary: This Document gives advice and standards for the geometric design of major / minor priority junctions with regard to traffic operation and safety.

REGISTRATION OF AMENDMENTS

Amend No	Page No	Signature & Date of incorporation of amendments	Amend No	Page No	Signature & Date of incorporation of amendments

REGISTRATION OF AMENDMENTS

Amend No	Page No	Signature & Date of incorporation of amendments	Amend No	Page No	Signature & Date of incorporation of amendments

PART 6

TD 42/95

**GEOMETRIC DESIGN OF
MAJOR/MINOR PRIORITY
JUNCTIONS**

Contents

Chapter

1. Introduction
2. Form of Major/Minor Priority Junction
3. Siting of Major/Minor Priority Junctions
4. Safety
5. Road Users' Specific Requirements
6. Landscaping
7. Geometric Design Features
8. Assembly of Design Elements
9. References
10. Enquiries

- Annex 1 Calculation of Capacity
Annex 2 Design of Channelising Islands

1. INTRODUCTION

General

1.1 The treatment of major/minor priority junctions has recently been the subject of a study sponsored by the Department of Transport. This study reviewed the existing advice given in Advice Note **TA 20/84** on the **Layout of Major/Minor Junctions**, and made recommendations on the amendments and additions to the document based on research carried out since 1984, and on current good practice.

1.2 As a result of the study, this standard now provides details of the latest requirements and recommendations on general design principles and safety aspects of the geometric design of major/minor priority junctions.

1.3 This document replaces Advice Note **TA 20/84**.

1.4 Guidance on the selection of the most appropriate form of junction is given in **TA 30 (DMRB 5.1)** and **TA 23 (DMRB 6.2)**.

1.5 The main changes and additions from **TA 20/84** can be summarised as follows:-

- a. Visibility requirements are mandatory (paras 7.3 - 7.11).
- b. The 15.5m long articulated goods vehicle with a single rear axle trailer has been replaced as the Design Vehicle by the 16.5m long articulated vehicle (paras 7.14 - 7.16).
- c. The standard layouts in **TA 20/84** have been replaced by figures which illustrate the design elements and their assembly.

Scope

1.6 This Standard defines the main types of major/minor priority junction which can be used on new and improved trunk roads.

1.7 Advice is also given on the choice between the different types of major/minor priority junction, and on the siting of such junctions.

1.8 Key safety issues are outlined, as are those particular design issues relating to landscaping and the specific requirements of road users.

1.9 Further recommendations are given on the geometric design of the important elements of the major/minor priority junction, and the way in which the individual components can be brought together to produce a good overall design.

Implementation

1.10 This Standard shall be used forthwith on all schemes for the construction, improvement and maintenance of trunk roads, currently being prepared provided that, in the opinion of the Overseeing Organisations, this would not result in significant additional expense or delay progress. Design Organisations should confirm its application to particular schemes with the Overseeing Organisation.

Definitions

1.11 The **major** road is the road to which is assigned a permanent priority of traffic movement over that of the other road or roads.

1.12 A **minor** road is a road which has to give priority to the major road.

1.13 The three basic types of major/minor priority junction on single carriageways are defined in the following paragraphs.

1.14 **Simple Junction.** A T- or staggered junction without any ghost or physical islands in the major road, and without channelising islands in the minor road approach (Fig 1/1).

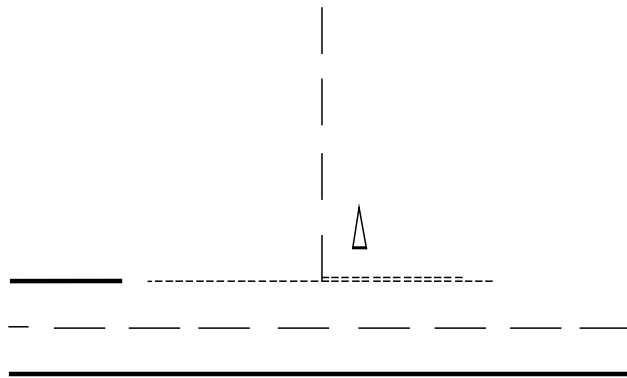

Figure 1/1 :Simple T-Junction
(paras 1.14, 1.19)

1.15 **Ghost Island Junction.** An at-grade junction, usually a T- or staggered junction, within which an area is marked on the carriageway, shaped and located so as to direct traffic movement (Fig 1/2).

1.16 **Single Lane Dualling.** An at-grade junction, usually a T- or staggered junction, within which central reservation islands are shaped and located so as to direct traffic movement (Fig 1/3).

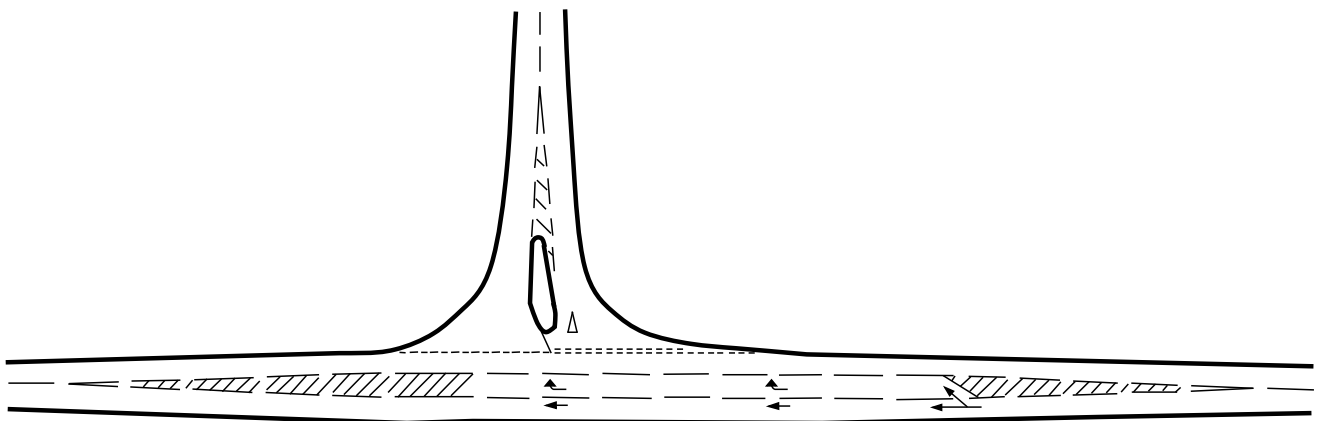

Figure 1 / 2 : Ghost Island Junction (para 1.15)

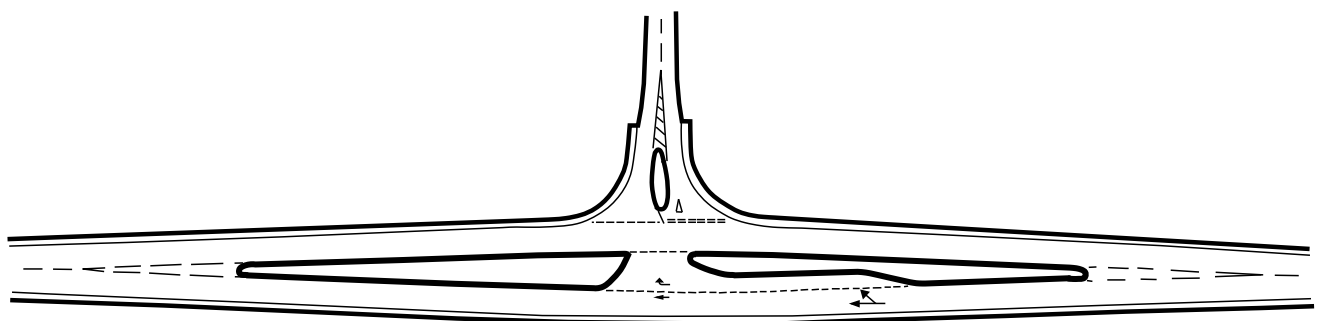

Figure 1/3 : Single Lane Dualling (para 1.16)

1.17 In addition, there are four basic configurations.

1.18 **Crossroads.** An at-grade junction of two roads that cross approximately at right angles (Fig 1/4).

1.19 **T-Junction.** An at-grade junction of two roads, at which the minor road joins the major road approximately at right angles (Fig 1/1).

1.20 **Skew or Y-Junction.** An at-grade junction of two roads, at which the minor road approaches the major road at an oblique angle and terminates at the junction (Fig 1/5).

1.21 **Staggered Junctions.** An at-grade junction of three roads, at which the major road is continuous through the junction, and the minor roads connect with the major road so as to form two opposed T-junctions (Fig 1/6).

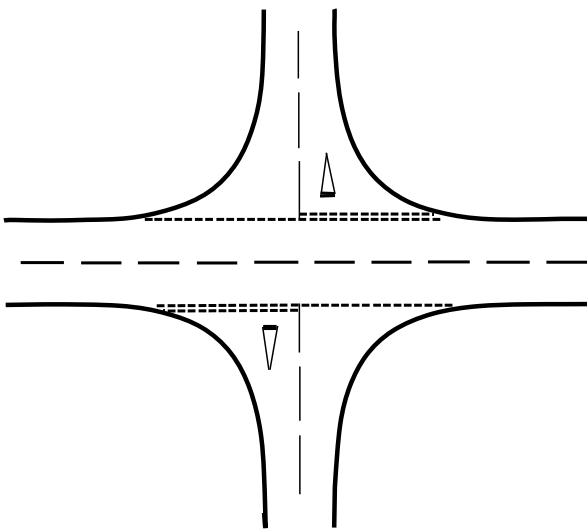

Figure 1/4 : Crossroads (para 1.18)

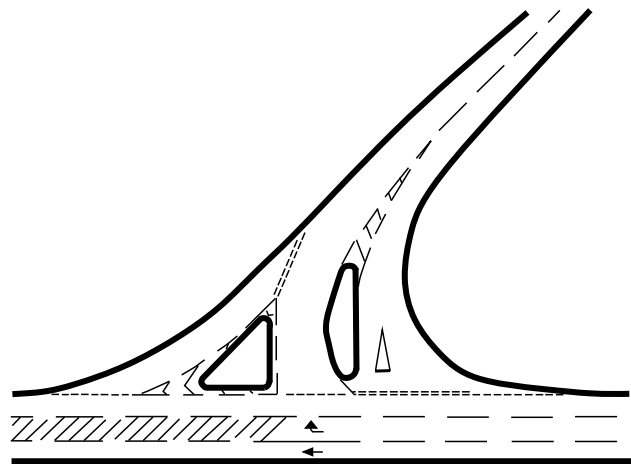

Figure 1/5 : Left Hand Splay Skew Junction
(para 1.20)

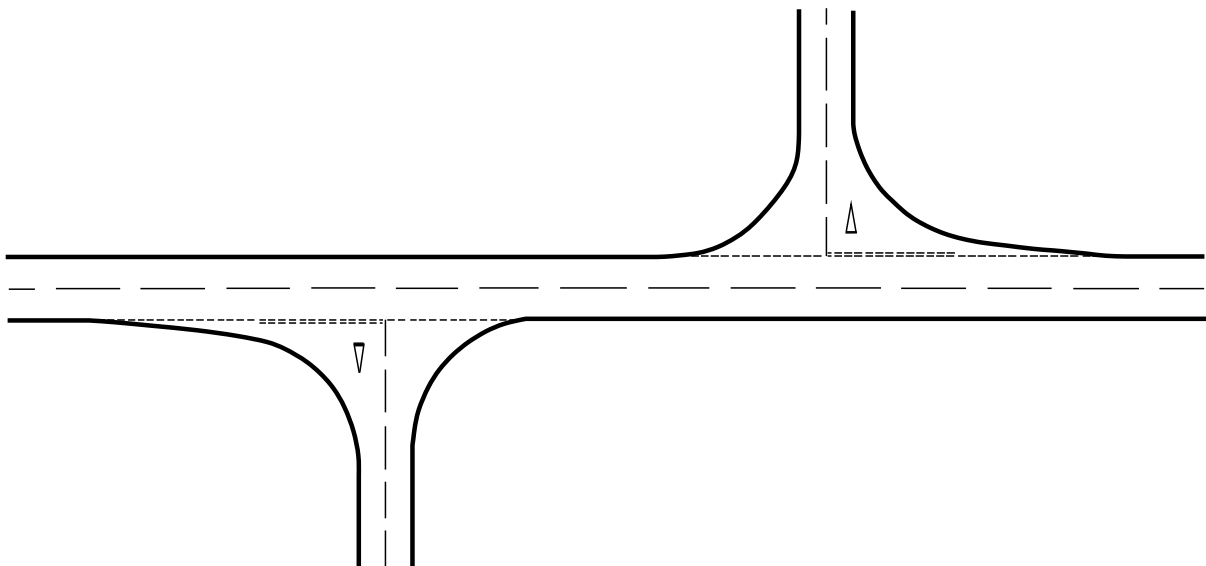

Figure 1/6 : Simple Right/Left Stagger (para 1.21)

Mandatory Sections

1.22 Sections of this document which are mandatory standards which the Overseeing Organisation expects in design, are highlighted by being contained in boxes. These are the sections with which the Design Organisation must comply or must have agreed a suitable departure with the relevant Overseeing Organisation. The remainder of the document contains advice and enlargement which is commended to designers for their consideration.

Relaxations

1.23 In difficult circumstances, the Design Organisation may relax a mandatory standard set out in this document to that relating to the next lowest design speed step, unless this document specifically excludes it. However, in using any such relaxation, the Design Organisation shall give special attention to the effect this relaxation may have on the overall performance of the junction. This is particularly important in the situation where two or more relaxations are incorporated into different components of the junction design. In all instances of relaxations, the Design Organisation shall record the fact that a relaxation has been used in the design and the corresponding reasons for its use. On completion of the design, the Design Organisation shall report all decisions to the Overseeing Organisation.

Departures from Mandatory Standards

1.24 In very exceptional situations Overseeing Organisations may be prepared to agree to Departures from Mandatory Standards where these seem unachievable. Design Organisations faced by such situations and wishing to consider pursuing this course shall discuss any such option at an early stage in design with the relevant Overseeing Organisation. Proposals to adopt Departures from Standard must be submitted by the Design Organisation to the Overseeing Organisation and formal approval received BEFORE incorporation into a design layout to ensure that safety is not significantly reduced.

2. FORM OF MAJOR/MINOR PRIORITY JUNCTIONS

General

2.1 Major/minor priority junctions are the most common form of junction control. Traffic on the minor road gives way to traffic on the major road and is normally controlled by "Give Way" signs and road markings. However, where there are severe visibility restrictions, "Stop" signs and road markings may be considered, with appropriate reference to the **Traffic Signs Regulations and General Directions**.

2.2 The advantage of all major/minor priority junctions is that through traffic on the major road is not delayed. However, high major road speeds or the possibility of major road overtaking traffic manoeuvres should not be encouraged at major/minor priority junctions.

2.3 For more heavily used junctions, more complex forms of junction layout are required. Due to the uncertainty of traffic forecasting, designers should always consider whether the layout they are designing could be upgraded to provide more capacity, if this should prove necessary in the future.

Design Procedure

2.4 Junction design is a key element of the overall design process for trunk road schemes. The flow chart shown in Fig 2/1 outlines the design process for major/minor priority junctions in a series of interrelated design steps.

2.5 The decision to provide a major/minor priority junction rather than some other form of junction should be based on operational, economic and environmental considerations. [Step 1] Guidance on junction choice is provided in **TA 30 (DMRB 5.1.6)**. However, sequences of junctions should not involve many different layout types. A length of route or bypass containing roundabouts, single lane dualling, ghost islands, simple priority junctions and grade separation would inevitably create confusion and uncertainty for drivers and may result in accidents. Safe road schemes are usually straightforward, containing no surprises for the driver.

2.6 The most appropriate type of major/minor priority junction to be used can be chosen from those described in Chapter 1. This decision should be based

on a wide range of factors, taking into account design year traffic flow, the nature and proportions of large goods and passenger carrying vehicles, geometric and traffic delays, an initial estimate of entry and turning stream capacities, and accident costs. It should also be based on a consideration of the particular site characteristics such as development and topography. [Step 2]

2.7 The next step is to address all of the relevant safety issues to ensure as safe a design as possible, to take account of road users' specific requirements and to incorporate a preliminary landscape design within the junction. At this point, the key geometric parameters of the junction design should be assessed. [Steps 3a-3d]

2.8 Having established the various components of the junction design, the Design Organisation should check that the capacity of the junction is still adequate. This includes a check if the junction is located on a route which might experience a wide variation in flow and turning movements, particularly those having prolonged daily peak periods, over a day, week, or year. The check should be undertaken prior to assembling the component parts to form a complete junction. [Step 4]

2.9 Before proceeding to final design [Step 5], a "driveability" check should then be performed, to assess first the smooth assembly of the components of the junction design. This should include a visual assessment of the junction on all approaches from the driver's eye view. Secondly, the junction should be considered within the context of its adjacent links and those adjacent junctions on the particular route. As a whole, the layout should be designed to suit the traffic pattern, with the principal movements following smooth vehicular paths. This improves the smoothness of operation and makes it more readily understood by drivers.

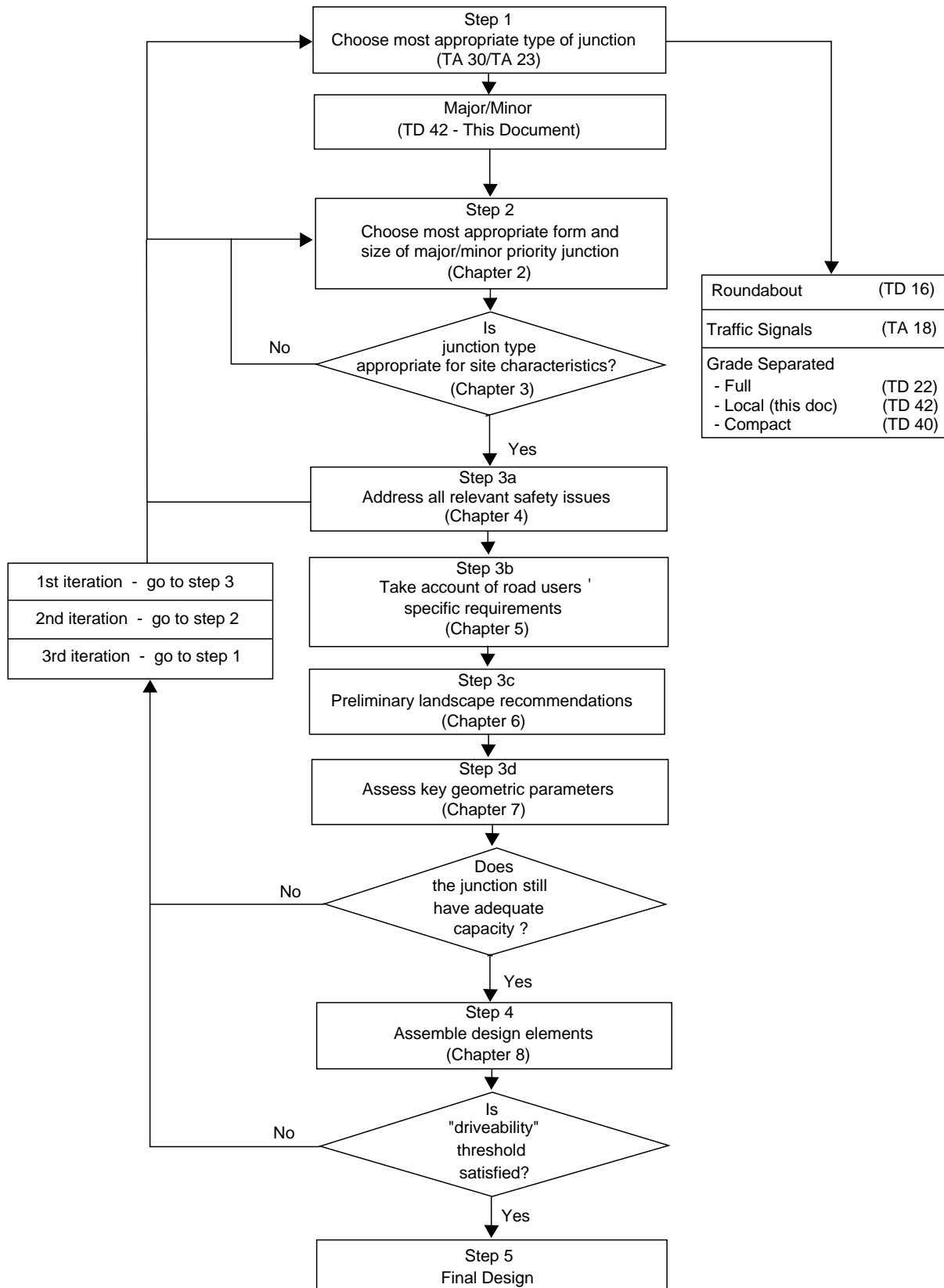

Figure 2/1 : Flow Chart Outlining Design Procedure (para 2.4)

2.10 If, at any point in the design procedure, the junction design is unsatisfactory, then the designer should return to the previous step in the procedure to refine the design. In certain extreme cases, this process could result in a change in junction type or form.

Choice of Major/Minor Priority Junction

2.11 Table 2/1 shows the major/minor priority junction forms considered suitable for various major road carriageway types in both urban and rural situations. This Table should be used as a starting point in choosing the most appropriate type of major/minor priority junction to use at a particular site.

Carriageway Type		Junction Type								
		Simple			Ghost Island			Dualling		
Standard	Location	T	Staggered	Crossroads	T	Staggered	Crossroads	T	Staggered	Crossroads
S2	Urban	Yes	Yes	Maybe	Yes	Yes	No	Yes (D1)	Yes (D1)	No
	Rural	Yes	Yes	Maybe	Yes	Yes	No	Yes (D1)	Yes (D1)	No
WS2	Urban	No	No	No	Yes	Yes	No	Yes (D1)	Yes (D1)	No
	Rural	No	No	No	Yes	Yes	No	Yes (D1)	Yes (D1)	No
D2	Urban	No	No	No	No	No	No	Yes (D2)	Yes (D2)	No
	Rural	No	No	No	No	No	No	Yes (D2)	Yes (D2)	No
D3		No	No	No	No	No	No	No	No	No

T Junction Staggered Junction Crossroads

Table 2/1: Possible Junction Types for Different Major Road Carriageway Types

2.12 Fig 2/2 may be useful when considering further the options for a site. For single carriageway roads it shows approximately the various levels of T-junction which may be applicable for different combinations of flows. The information takes into account geometric and traffic delays, entry and turning traffic flows, and accident costs. However, it must be noted that Fig 2/2 gives the starting point for junction choice and there are other factors such as those indicated in para 2.6 to be considered before a final decision is made.

2.13 Ordinarily, the 2-way Annual Average Daily Traffic (AADT) design year flows are used to determine the approximate level of junction provision for new junctions. However, if there is evidence in the area of the junction of high seasonal variations, or if short, intense peaks in the traffic flows are likely, then consideration should be given to using either the appropriate seasonal or peak hour flows in the initial capacity assessment detailed in para 2.6, or to justify a different type of junction.

2.14 The following principles can be identified from Table 2/1 and Fig 2/2.

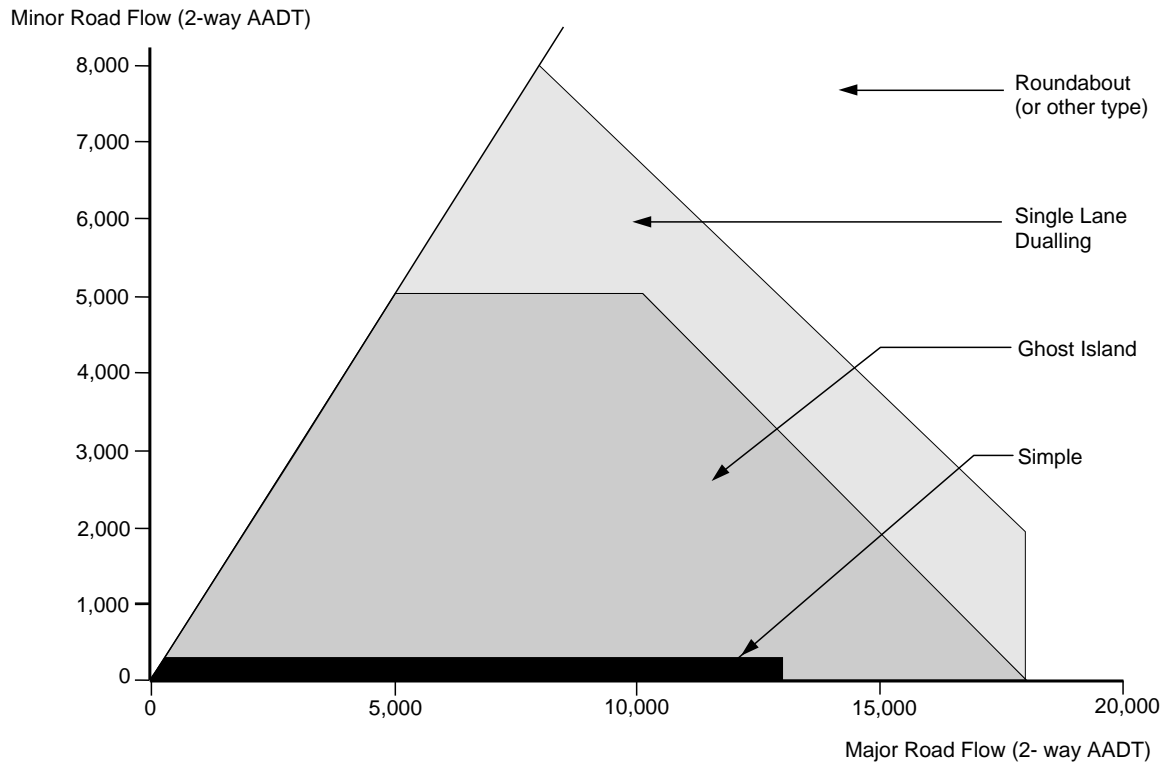

Figure 2/2 : Approximate Level of Provision of T-junctions on New Single Carriageway Roads for Various Major and Minor Road Design Year Traffic Flows (paras 2.2, 2.14)

Simple

2.15 Simple junctions are appropriate for most minor junctions on single carriageway roads, but must not be used for wide single carriageways or dual carriageways. For new rural junctions they shall only be used when the design flow in the minor road is not expected to exceed about 300 vehicles 2-way AADT, and that on the major road is not expected to exceed 13,000 vehicles 2-way AADT.

2.16 At existing rural, and at urban junctions the cost of upgrading a simple junction to provide a right turning facility will vary from site to site. However, upgrading should always be considered where the minor road flow exceeds 500 vehicles 2-way AADT, a right turning accident problem is evident, or where vehicles waiting on the major road to turn right inhibit the through flow and create a hazard.

2.17 In those instances where the flow levels are not great enough to justify the provision of a right turning facility, and a right turning problem remains, consideration may be given to the use of a low cost remedial measure. Two such measures include a nearside passing bay, to allow through vehicles to pass those right turners waiting in the centre of the major road, albeit at a reduced speed, or a left hand diverging lane loop, which allows right turners to wait off the major road, and to make the crossing movement at right angles.

These are shown in Figs 2/3 and 2/4.

2.18 The decision to provide a right turning facility shall be made in accordance with the warrants given in paras 2.15 and 2.16. The choice of type of right turn facility to be used, however, will depend on the particular site characteristics.

Ghost Island

2.19 The use of ghost islands on unrestricted rural single carriageway roads can, in certain circumstances, pose safety problems. In situations where overtaking opportunity on the major road on either side of the junction is restricted, the presence of a widened carriageway, albeit with hatch markings, could result in overtaking manoeuvres which may conflict with right turns into and out of the minor road.

2.20 Ghost islands shall be used on new single carriageway roads, or in the upgrading of existing junctions to provide right turning vehicles with a degree of shelter from the through flow. They are highly effective in improving safety, and are relatively cheap, especially on wide 2-lane single carriageway roads where very little extra construction cost is involved.

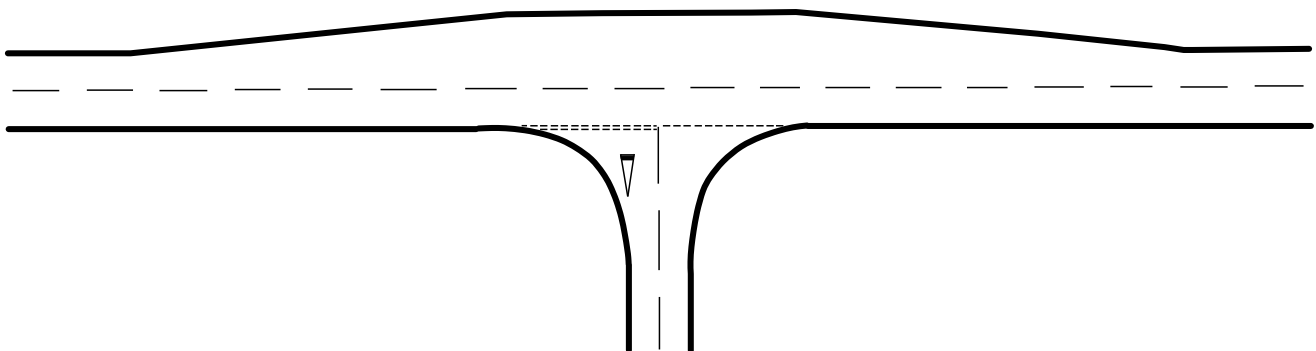

Figure 2/3 : Major/Minor Priority Junction with Nearside Passing Bay (para 2.17)

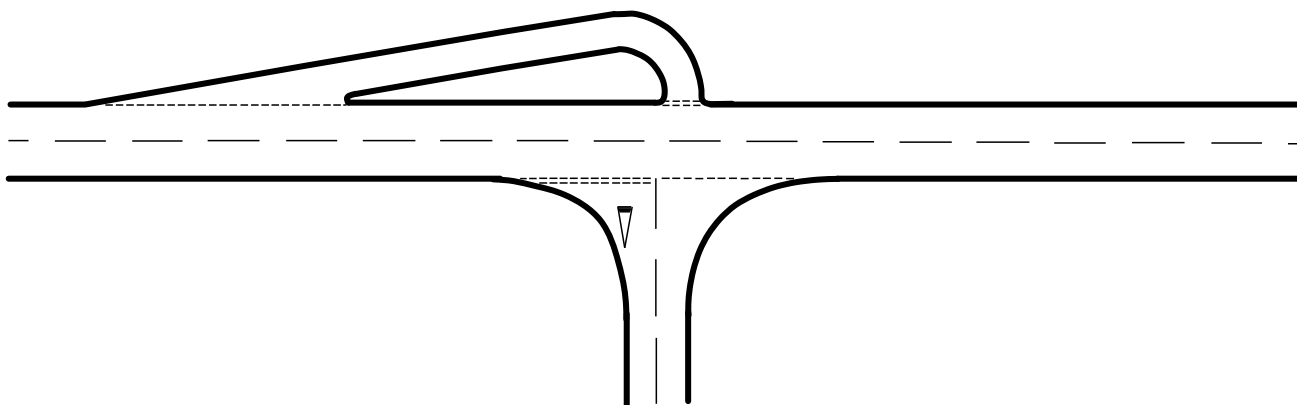

Figure 2/4 : Major / Minor Priority Junction with Left Hand Diverging Lane Loop for Right Turns (para 2.17)

2.21 Ghost islands shall not be used where overtaking opportunities on adjacent links are restricted or where traffic turning right out of the minor road would need to make this manoeuvre in two stages.

2.24 There are certain conditions under which a single lane dualling layout may be misinterpreted by drivers. Where a road contains alternating single and dual carriageway sections, a single lane dualling layout might lead drivers into mistaking the width of divided carriageway at the junction to think they are approaching a fully dualled section with overtaking opportunities. In addition, where a junction is proposed on a single carriageway within about 3 kilometres of the taper from a long length of dual carriageway, there may also be confusion if single lane dualling is introduced. In both of these cases, single lane dualling shall not be used. Single lane dualling shall not be used where there is a climbing lane in one direction through the junction.

Single Lane Dualling

2.22 Single lane dualling can be used on unrestricted rural single carriageway roads to prevent overtaking on the major road, and/or where it is desirable for the right turn out of the minor road to be carried out in two stages. However, even though overtaking is prevented, when major road drivers are presented with an improved highway layout and standard there may be a tendency to speed up through the junction where slow moving vehicles may be crossing or turning. Consequently, care needs to be taken when siting this type of junction, particularly at the start of rural bypasses.

2.23 Single lane dualling shall normally be used on rural single carriageway roads that have good overtaking opportunities on adjacent links, and shall be used in preference to ghost islands where overtaking opportunities on adjacent links are restricted and where traffic turning right out of the minor road would need to make this manoeuvre in two stages. Because of the detailed nature of the single lane dualling layout, it is only appropriate for roads with hard strips.

2.25 Single lane dualling is formed by widening the major road to provide a central reservation, a right turning lane and space for vehicles waiting to turn right from the major road into the minor road (Fig 2/3). They also enable drivers of vehicles of nearly all lengths to undertake the right turn manoeuvre from the minor road in two stages. The limiting factor is the left hand sideways visibility from the driver's seat, which can be very restricted in some cabs and leaves the driver with no option but to make the manoeuvre in one stage. An important feature of this type of junction is that there is only one through lane in each direction on the major road. This form of junction is designed to prevent overtaking and excessive speeds through the conflict zones.

Dual Carriageway Junctions

2.26 Major/minor priority junctions may also be used on dual carriageway, but should never be provided on D3AP roads. The upper limit for minor road flows should be taken as about 3,000 vehicles AADT 2-way when considering providing a major/minor priority junction on continuous D2AP roads in rural areas.

However, short lengths of full dualling (D2AP) just to incorporate a junction on otherwise single carriageway roads shall not be provided.

2.27 On continuous dual carriageways, major/minor priority junctions are formed by widening the central reserve to provide an offside diverging lane and waiting space for vehicles turning right from the major road into the minor road (Fig 2/5). This allows vehicles of nearly all lengths turning right from the minor road into the major road to carry out the manoeuvre in two stages, but see the comment in para 2.25.

2.28 Where a long stretch of motorway or all-purpose carriageway with full grade separation becomes a D2AP with at-grade junctions, a roundabout should

always be used at the first major junction in order to emphasise to drivers the changed character of the road. This has been found to reduce accidents. In addition, major/minor priority junctions should not be provided at locations where a dual carriageway section reduces to single carriageway standard, such as at the end of a town bypass, since the merging manoeuvres resulting from such a layout may lead to an increase in accident potential. There should be at least 500 metres between the end of the junction and the signs announcing the end of the dual carriageway.

Crossroads

2.29 Crossroads are considered suitable only as simple junctions in urban and rural locations where the minor road flows do not warrant a ghost island or single lane dualling. Staggered junctions are safer than crossroads where a significant proportion of the flow on the minor roads is a cross movement.

Staggered Junctions

2.30 Staggered junctions comprise of a major road with opposed T-junctions on either side. Right/left staggers (where minor road traffic crossing the major road first turns right, proceeds along the major road and then turns left) are preferred to left/right staggers because traffic turning between the minor roads is less likely to have to wait in the centre of the major road.

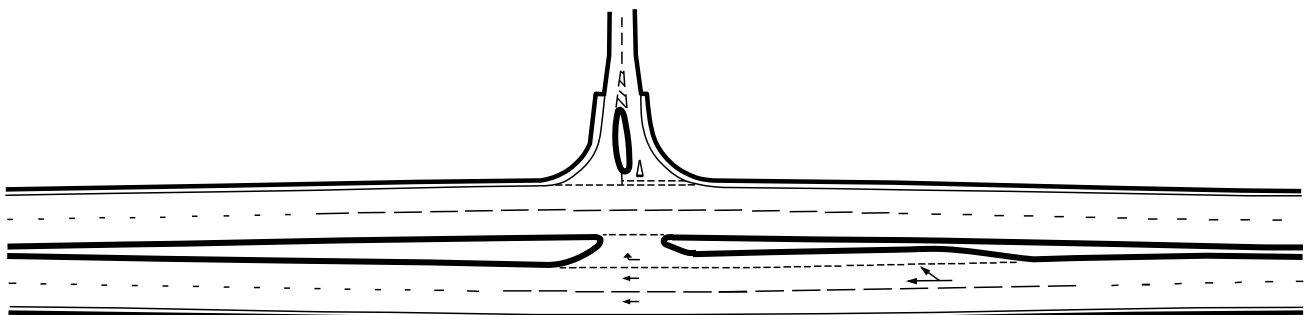

Figure 2/5 : Dual Carriageway T-Junction (para 2.25)

Capacity Assessment

2.31 For design involving flows greater than the low flows described in the preceding paragraphs, use should be made of the equations which are available for the prediction of possible minor road entry flows into a major/minor priority junction as a function of the flow/geometry at the junction. These equations are reproduced at Annex 1 and are applicable to all types of major/minor priority junctions including staggered junctions.

2.32 The range of reference flows developed should be used to produce trial designs for assessment. Consideration of a lower flow to capacity ratio (RFC) of 75% is recommended in Annex 1 as a general rule when considering single carriageways with design speeds of 100 kph and above or high speed dual carriageways. This is because formulae have not been developed for these latter types of road.

2.33 Manual or computerised methods such as PICADY/3 may be used to assess capacity. It is not realistic to calculate queue lengths and delays manually.

3. SITING OF MAJOR/MINOR PRIORITY JUNCTIONS

General

3.1 On new single carriageways where overtaking opportunity is limited, ghost island and single lane dualling junctions should be sited on non-overtaking sections, as defined in Departmental Standard **TD 9 (DMRB 6.1.1)**. On existing single carriageway roads along which overtaking opportunity is very limited, the isolated local improvement of a junction to a ghost island could induce unsafe driver behaviour, since the short length of wider road thus created may be used by some frustrated drivers for overtaking.

3.2 Measures that have been found to reduce the number of such manoeuvres at existing ghost island or single lane dualling junctions include

a. The application of diagonal hatched road markings in the metre strips at an existing single lane

dualling junction, which gives a more confined impression to approaching drivers, as shown in Fig 3/1.

b. The use of double white lines along the hatching boundary at ghost island junctions, as shown in Fig 3/2.

c. The use of differential red coloured surfacing within the hatched area of the ghost island.

3.3 A saving in accidents may be achieved, and an improvement made in operational performance, by reducing the number of lightly trafficked minor road connections onto major roads. The cost effectiveness of connecting such routes together with a link road before they join a new major road should always be investigated.

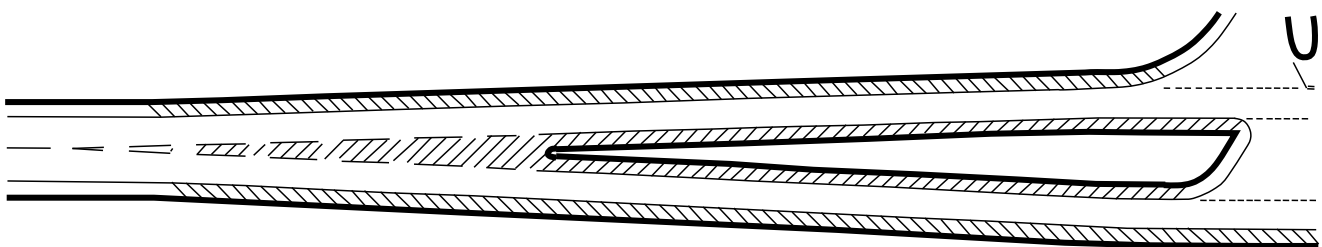

Figure 3/1 : Use of Hatching in Metre Strips to Eliminate Overtaking Manoeuvres (para 3.2)

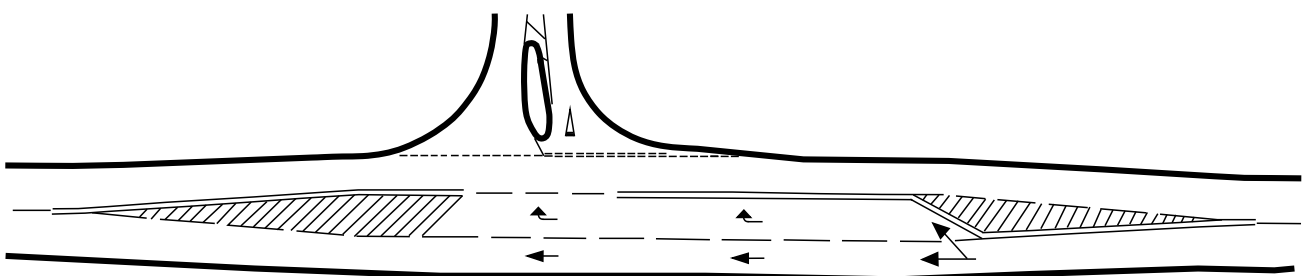

Figure 3/2 : Use of Double White Line Ghost Island Hatching Boundary to Eliminate Overtaking Manoeuvres (para 3.2)

Horizontal Alignment

3.4 Ideally, major/minor priority junctions should not be sited where the major road is on a sharp curve. However, where the siting of a major/minor priority junction on a curve is unavoidable, the preferred alignment is where T-junctions are sited with the minor road on the outside of the curve. This is especially important for junctions on climbing lane sections or dual carriageways, to ensure that minor road traffic has a clear view of vehicles on the major road that may be overtaking through the junction. Junctions on the inside of sharp curves are most undesirable.

3.5 Problems have been experienced with major/minor priority junctions containing a skew minor road at the end of some town bypasses where the alignment is such that some drivers perceive that the minor road retains priority. In such circumstances, the minor road approach should be aligned so as to join the major road as near to right angles as possible in order to eliminate any driver confusion as to which route has priority.

Vertical Alignment

3.6 The best locations for junctions are on level ground, or where the gradient of the approaches does not exceed 2% either uphill or downhill. Downhill approaches in excess of this figure, particularly on high speed roads, can induce traffic speeds above those desirable through the junction, and lead to a misjudgment of the approach speed by drivers entering from the minor road. Uphill approaches are also undesirable since it is difficult for drivers to appreciate the layout of a junction when they are approaching it on an up gradient. They cannot see the full layout from the lengths immediately on either side of the crest.

3.7 Where the minor road approaches the junction on an uphill gradient, drivers can often wrongly perceive the junction form, and will require a longer gap between vehicles to pull out onto the major road. This is undesirable, as is the case where the minor road approaches a junction on a downhill gradient, thus increasing the likelihood of vehicles overrunning the "Give Way" line.

In such circumstances, a designer shall attempt to create a level section of at least 15 metres length adjacent to the major road.

3.8 Sections in the central reserve opening at single lane dualling and dual carriageway junctions should fall for drainage purposes, towards rather than away from, the minor road, particularly where there is superelevation across the main carriageway. In such instances where this does not occur, drivers may not be able to see the full width of the furthest carriageway from their position on the minor road. They may not immediately appreciate the road they are joining is a dual carriageway, particularly with single lane dualling. Fig 3/3 shows a computer simulated view of this situation. A form of optical illusion may also be created, whereby the width available in the central reserve, to make the right turn out of the minor road in two stages, appears insufficient to accommodate waiting vehicles. In this situation the minor road driver may attempt to perform the manoeuvre in one stage. It is better to have the outside edge of each superelevated carriageway at the same level.

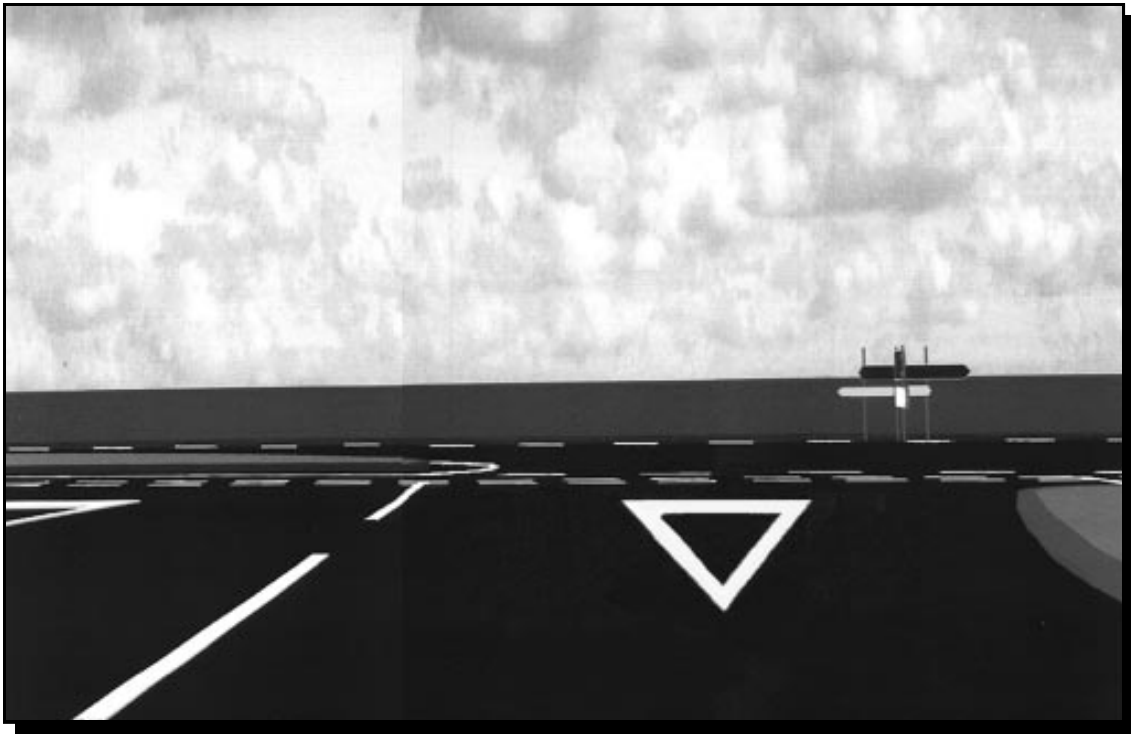

Figure 3/3: Computer Simulated View of Minor Road Approach with Superelevation across the Main Carriageway

4. SAFETY

4.1 In 1991 there were 236,000 personal injury accidents in Great Britain. Approximately 51% of these accidents occurred at urban road junctions and 9% occurred at rural road junctions. Of the 51% that occurred at urban junctions, over half occurred at major/minor priority junctions. Of the 9% that occurred at rural junctions, just under half occurred at major/minor priority junctions. Therefore, accidents at a major/minor priority junction accounted for approximately one third of the total number of road accidents in Great Britain in 1991. However, balanced against these figures, 74% of rural trunk and principal road junctions in Great Britain are major/minor priority junctions.

4.2 For the same flows a major/minor priority junction will usually have a higher accident rate than other junction types. These accidents will in themselves be more serious than at other forms of control. They are mainly associated with right turns and are exacerbated in number and severity by high major road speeds or the possibility of incautious overtaking traffic manoeuvres occurring on the major road. Accidents involving the right turn from the major road (22%) and the right turn out of the minor road (27%) are the most frequent at major/minor priority junctions.

4.3 Various methods which have been shown to enhance safety at these junctions in the past include:-

a. The installation of a ghost island on single carriageway roads to shelter right turning traffic and discourage overtaking. The study on rural T-junctions, summarised in **TRL RR 65**, demonstrated that the frequency of accidents involving a right turn from the major road is some 70% less at junctions with a ghost island, than at simple junctions.

b. The use of double white line markings or raised rib markings along the hatching boundary, or the application of differential coloured surfacing within the hatched area at ghost islands to discourage dangerous overtaking manoeuvres at the junction.

c. For more heavily trafficked junctions on rural single carriageway roads, the installation of physical islands to achieve single lane dualling. Full dualling should not be used as this encourages high speeds and overtaking, which are undesirable at major/minor priority junctions.

d. The application of hatching in the metre strips at single lane dualling junctions has been shown to give a more confined impression to approaching drivers and hence reduce speeds.

e. The replacement of a rural crossroads by a staggered junction. This has been shown to reduce accidents by some 60%.

f. The installation of channelising islands on the minor road approaches at rural crossroads. This has been shown to reduce accidents (mainly minor road overrun) by about 50%.

g. The improvement of visibility. However, care should be taken not to provide visibility to the right on the minor road approach much in excess of the desirable minimum as this can divert the driver's attention away from road users on the mainline in the immediate vicinity towards those approaching in the far distance.

h. The provision and maintenance of good skid resistant surfaces.

i. The conversion of urban major/minor priority junctions to traffic signal or roundabout control. The latter has been shown to reduce accidents by 30% or more.

j. The installation of pedestrian guard rails, central refuges and pedestrian crossings in urban areas.

k. On high speed dual carriageways, the prevention of right turn crossing manoeuvres at the junction and use of a roundabout or a grade separated crossing close to the major/minor priority junction for the purpose of U-turns by the diverted traffic. Such a method of local grade separation eliminates the two manoeuvres contributing most to accidents at major/minor priority junctions. The design of such layouts is covered more fully in Chapter 7 and in **TD 40 (DRMB 6.2) "Layout of Compact Grade Separated Junctions"**.

4.4 More general advice on the safety of junctions is given in the **Accident Investigation and Prevention Manual**.

5. ROAD USERS' SPECIFIC REQUIREMENTS

General

5.1 In designing major/minor priority junctions, it is important to take account of the specific requirements of road users. The high speed nature of rural trunk roads is such that specific facilities may be required at some locations in order to ensure the safe passage of specific road users through the junction. This is equally true at some urban sites where some junctions may be used intensively by all types of road user.

Cyclists' Facilities

5.2 Major/minor priority junctions present a hazard for pedal cyclists, and 73% of cyclist accidents at junctions occur at major/minor priority junctions. It is therefore important that a cyclist is provided with a safe passage through the junction, and that the design of any cyclist facilities should take into account both their vehicular rights and their particular vulnerability, as suggested by the accident statistics.

5.3 Consideration should be given to cyclists where an existing cycle lane crosses the minor road (Fig 5/1). In this instance, the greatest danger has been found to be a collision with vehicles emerging from the minor road, and from motor vehicles turning right or left from the major road and thus cutting across the path of the cyclist.

5.4 The provision of dedicated cyclist facilities is covered in **TA 57 (DMRB 6.3)**, and further recommendations are given in **Local Transport Notes**.

5.5 Bearing in mind the practicalities and economics, it is important to consider the provision of facilities that take cyclists away from the mouth of the junction. This will minimise the interaction between cyclists and motor vehicles and provide safe crossing points.

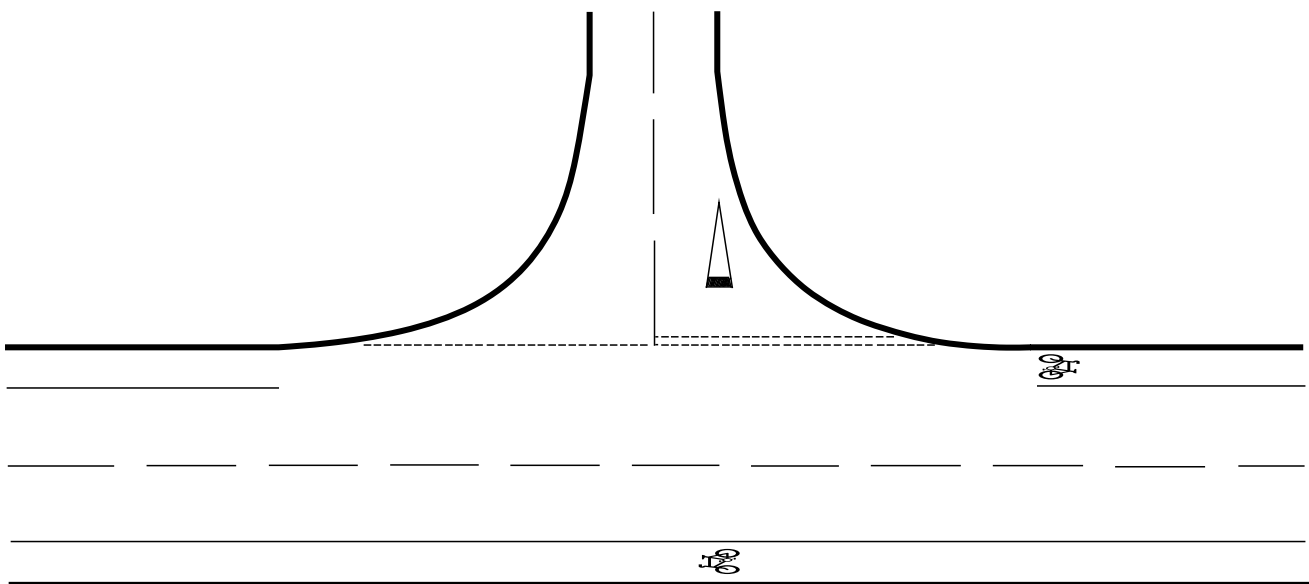

**Figure 5/1 : Simple Major / Minor Priority Junction with a With-Flow
Cycle Lane on the Major Road
(para 5.3)**

5.6 Such facilities may include the following:-

- a. Shared use by pedestrians and cyclists of a displaced cycle track/footway with a controlled or uncontrolled crossing.
- b. A signposted alternative cycle route away from the junction.
- c. Full grade separation, for example by means of a combined pedestrian/cyclist subway system.

If provision of any of these is not possible, then greater emphasis should be placed on the safety aspects of the design of the major/minor priority junction layout, by careful attention to the provision of crossing places.

5.7 In urban areas, if the volume of cyclists is significant, but not high enough to justify economically a grade separated crossing, then consideration may be given to signalling the whole junction.

Equestrians' Facilities

5.8 Where it is expected that there will be regular use of the junction approaches by ridden horses, of the order of more than 20 passages a week, consideration should be given to the provision of dedicated crossing places. Horses require longer headway between vehicles than cyclists and pedestrians, to allow an adequate margin of safety for crossing. Therefore, the location of such crossings should preferably be at some distance from the junction to permit suitable visibility by the rider. As set out in **TA 57 (DMRB 6.3)**, the visibility distances recommended are considerably greater for equestrians than those set out in Chapter 7 of this standard.

5.9 Advice on the design of at-grade equestrian crossings is given in **TA 57 (DMRB 6.3)**. This includes the extension of the grass verge at the crossing point to provide a "holding area" for the horses.

5.10 Displaced routes at major/minor priority junctions are to be preferred, although the use of grass verges by ridden horses may have an indirect effect on road safety, in that the drainage system may be damaged, causing the carriageway to flood, or damaged verges may force pedestrians to walk on the carriageway. In such circumstances, strengthening of the verges may be required.

5.11 Alternatively, ridden horses could share cycle tracks where these are remote from the mouth of the junction, but should not be expected to use pedestrian

facilities.

Pedestrians' Facilities

5.12 The requirements of pedestrians should be carefully considered in the design and choice of major/minor priority junctions. Although it is preferable to provide separate pedestrian routes away from the junction, where road widths are less and traffic movements more predictable, this is rarely practical, in which case the following facilities should be considered:-

- a. A minor road central refuge at an unmarked crossing place (Fig 5/2) .
- b. Zebra crossing, with or without a central refuge.
- c. Displaced controlled pedestrian crossing.
- d. Subway or footbridge.

5.13 The type of facility selected will depend upon the volumes and movements expected of both pedestrians and traffic, and shall be designed in accordance with current recommendations and requirements - **BD 29 (DMRB 2.2)**; **TD 36 (DMRB 6.3.1)**; **TD 28, TA 52 (DMRB 8.5)**. The use of different types of pedestrian facility at the same junction is not recommended as this could lead to confusion by pedestrians and drivers.

5.14 At-grade pedestrian crossing points should not be placed in the mouth of the junction, instead they should be located away from the mouth where the carriageway is relatively narrow. In urban areas, where pedestrian flows are relatively low, it is possible to provide a central refuge in the hatched area of a ghost island junction. However, where pedestrian flows are high, consideration should be given to a single lane dualling junction, even in circumstances where the traffic flows may not warrant such a provision, in order to enable pedestrians to make the crossing manoeuvre in two stages, and have a safe central waiting area.

5.15 Defined at-grade pedestrian crossing points on the minor road should be a minimum of 15m back from the "Give Way" line, and should be sited so as to reduce to a minimum the width to be crossed by pedestrians provided they are not involved in excessive detours from their desired paths. Central refuges should be used wherever possible, but not in the major road in a rural situation.

5.16 In urban areas, where large numbers of pedestrians are present, guard rails or other deterrents should be used to prevent indiscriminate crossing of the carriageway. The design of guard railing should not obstruct drivers' visibility requirements. Guard rails which are designed to maintain drivers' visibility of pedestrians through them, and vice versa, are available, but should be checked in case blind spots do occur. **TA 57 (DMRB 6.3)** refers.

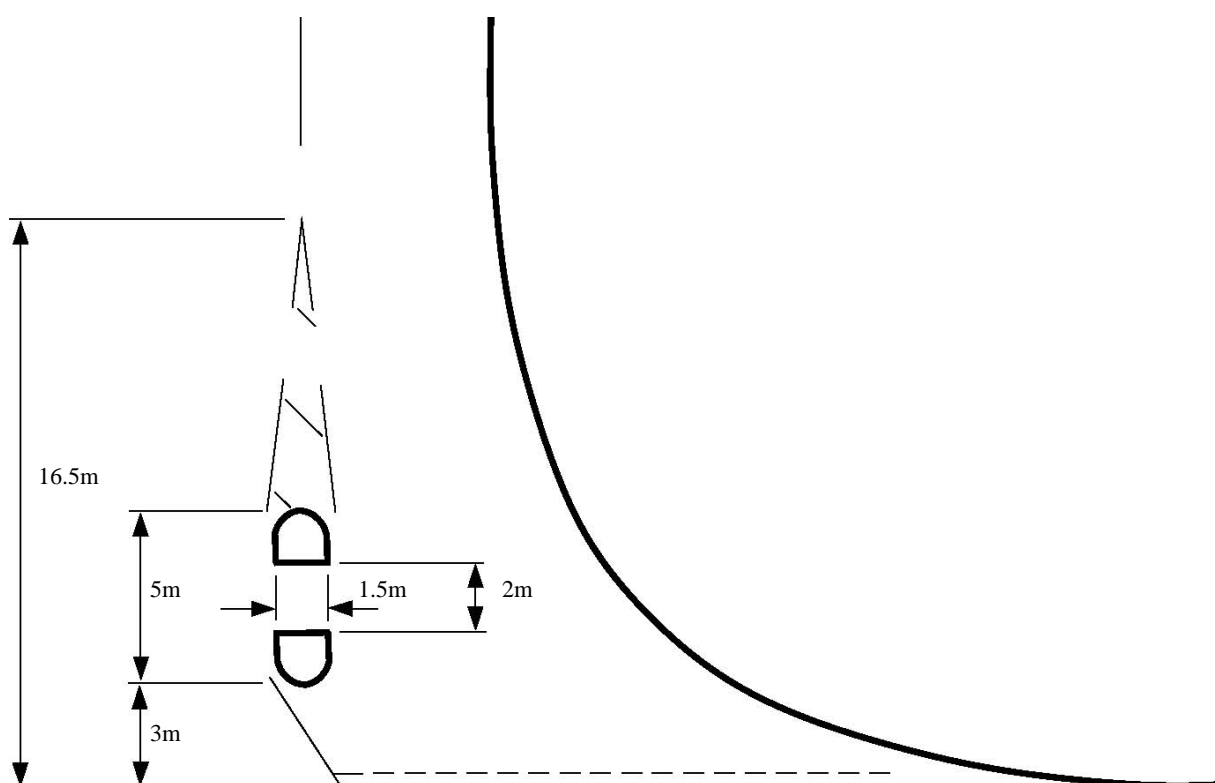

Figure 5/2: Typical Urban Separation Island (para 5.12)

6. LANDSCAPING

6.1 The design of landscaping within the highway limits shall be carried out in consultation with appropriate specialists. The Design Organisation shall consider the maintenance implications and where the responsibility for maintenance is passed to a third party, maintenance standards must be agreed. If third parties wish to enhance the standard of planting or landscaping at major/minor priority junctions, for example with special floral displays, this shall be with the agreement of the Overseeing Organisation, and shall not compromise visibility or safety. Further advice is given in **The Good Roads Guide, DMRB Volume 10**.

6.2 Apart from the amenity benefits, the landscape treatment of major/minor priority junctions can have practical advantages from a traffic engineering point of view. By ground modelling, perhaps in conjunction with planting, the layout of a major/minor priority junction can be made more obvious to approaching traffic.

6.3 Landscaping can play an important part in aiding drivers waiting to exit the minor road by providing reference points or features by which to judge the speed of drivers approaching on the major road. This is particularly useful where a major/minor priority junction is located in an open landscape, where there is a lack of natural reference points. Planting can also provide a positive background to the road signs around the junction, whilst visually uniting the various component parts. It is important that a wider view does not distract from the developing traffic situation as the driver sees it.

6.4 By careful planning, the areas required for visibility envelopes can be planted with species having a low mature height. Specialised planting, which may be more appropriate in an urban area, generally requires greater maintenance effort if it is to be successful. Any planting must have bulk and substance in winter as well as during the summer months. Too much visibility can be as problematic as too little and this can sometimes also be redressed by careful landscape treatment.

6.5 In rural areas, planting should be restricted to indigenous species and be related to the surrounding landscape. In an open moorland, for example, any planting of other than local species would appear incongruous and landscape treatment would normally be restricted to ground modelling. Conversely, in woodland areas, major/minor priority junctions should be as densely planted as the demands of visibility permit with due allowance for the situation that will develop with matured growth.

6.6 A well-defined maintenance programme should be developed if extensive planting is used to ensure that such planting does not obscure either approaching traffic or direction signs at any time.

7. GEOMETRIC DESIGN FEATURES

General

7.1 This chapter outlines the geometric design features to be considered in the design of major/minor priority junctions. Many of the features are dealt with separately, and a designer should work systematically through the design procedure prior to assembling the component parts. This is an iterative process, and it may be necessary to alter part of the junction design covered previously in order to achieve a satisfactory design.

Design Speed

7.2 Geometric standards for junctions are related to the traffic speed of the major road, and for new roads this is the design speed as defined in **TD 9 (DMRB 6.1.1)**. Reference should be made to **TD 9** in order to determine the appropriate design speed.

Visibility

7.3 Minor road traffic has to join or cross the major road when there are gaps in the major road traffic streams. It is therefore essential that minor road drivers have adequate visibility in each direction to see the oncoming major road traffic in sufficient time to permit them to make their manoeuvres safely. This concept also applies to major road traffic turning right into the minor road. As well as having adverse safety implications, poor visibility reduces the capacity of turning movements. Visibility shall however, not be excessive as this can provide a distraction away from nearer opposing traffic.

7.4 Drivers approaching a major/minor priority junction from both the major road and the minor road shall have unobstructed visibility as indicated in the following sections. The envelope of visibility for driver's eye height is as set out in **TD 9 (DMRB 6.1.1.2.2)**.

Major Road

7.5 Drivers approaching a major/minor priority junction along the major road approaches shall be able to see the minor road entry from a distance corresponding to the Desirable Minimum Stopping Sight Distance (SSD) for the design speed of the major road, as described in **TD 9 (DMRB 6.1.1)**. This visibility allows drivers on the major road to be aware of traffic entering from the minor road in time for them to be able to slow down and stop safely if necessary.

Minor Road

7.6 The principle of providing the required visibility for drivers approaching the junction from the minor road has three distinct features.

a. Approaching drivers shall have unobstructed visibility of the junction from a distance corresponding to the Desirable Minimum Stopping Sight Distance (SSD) for the design speed of the minor road, as described in **TD 9 (DMRB 6.1.1)**. This allows drivers time to slow down safely at the junction, or stop, if this is necessary. Where a "Give Way" sign is proposed the visibility envelope shall be widened to include the sign.

b. From a point 15m back along the centreline of the minor road measured from the continuation of the line of the nearside edge of the running carriageway of the major road (not from the continuation of the back of the major road hardstrip if this is present), an approaching driver shall be able to see clearly the junction form, and those peripheral elements of the junction layout. This provides the driver with an idea of the junction form, possible movements and conflicts, and possible required action before reaching the major road.

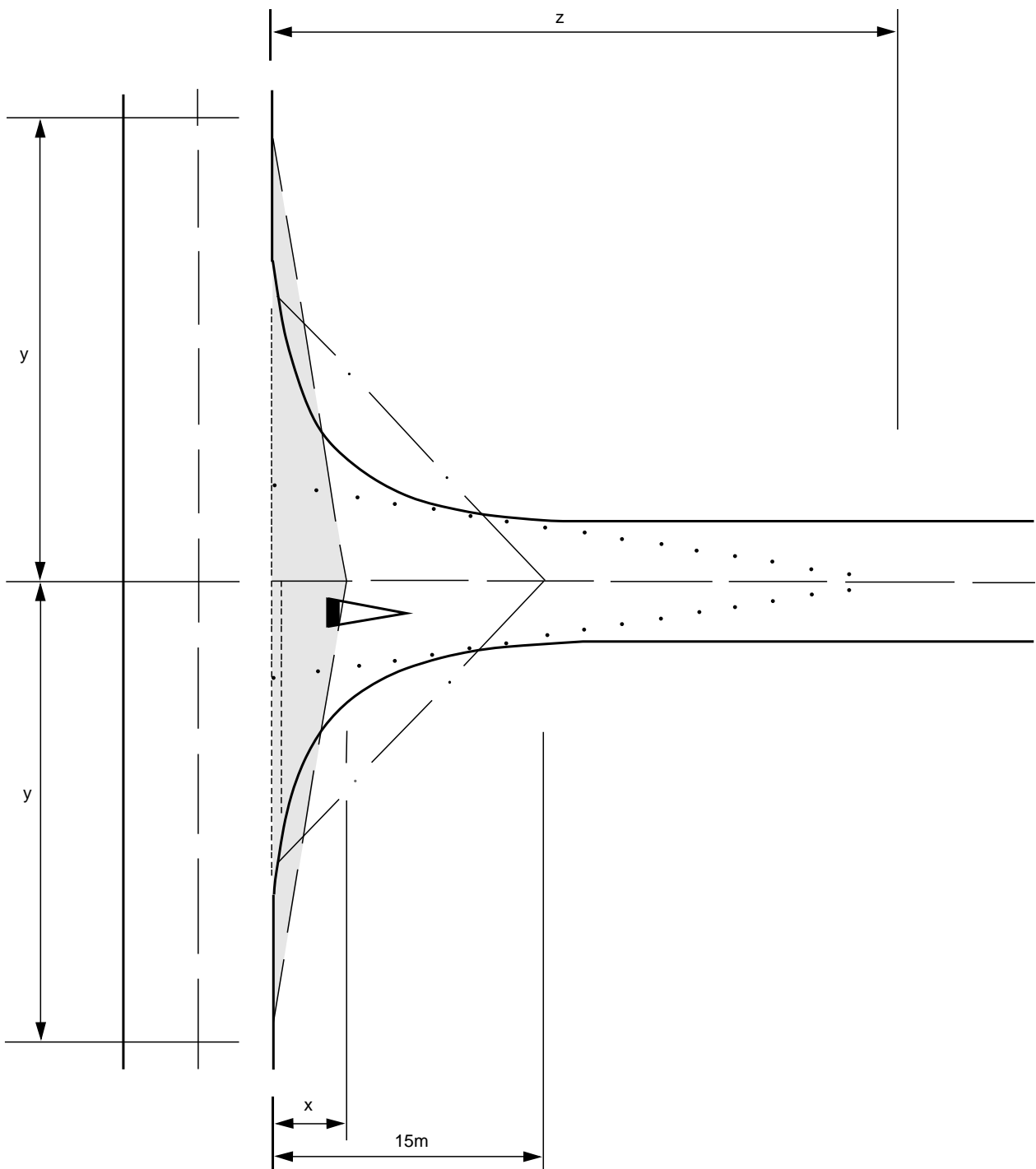

x "x" distance
 y "y" distance
 z Desirable Minimum Stopping Sight
 Desirable (SSD) for Approach Road
 Design Speed

— . — Lines over which unobstructed
 visibility should be provided

Figure 7/1 : Visibility Standards (para 7.6)

c. The distance back along the minor road from which the full visibility is measured is known as the 'x' distance. It is measured back along the centreline of the minor road from the continuation of the line of the nearside edge of the running carriageway of the major road. The 'x' distance shall be desirably 9m (but see para 7.8). From this point an approaching driver shall be able to see clearly points to the left and right on the nearer edge of the major road running carriageway at a distance given in Table 7/1, measured from its intersection with the centreline

of the minor road. This is called the 'y' distance and is defined in Fig 7/1. Relaxations are not available for this distance.

7.7 If the line of vision lies partially within the major road carriageway, it shall be made tangential to the nearer edge of the major road running carriageway, as shown in Fig 7/2.

Design Speed of Major Road (kph)	'y' Distance (m)
50	70
60	90
70	120
85	160
100	215
120	295

Table 7/1: 'y' Visibility Distances from the Minor Road (Relaxations not available - para 7.6c)

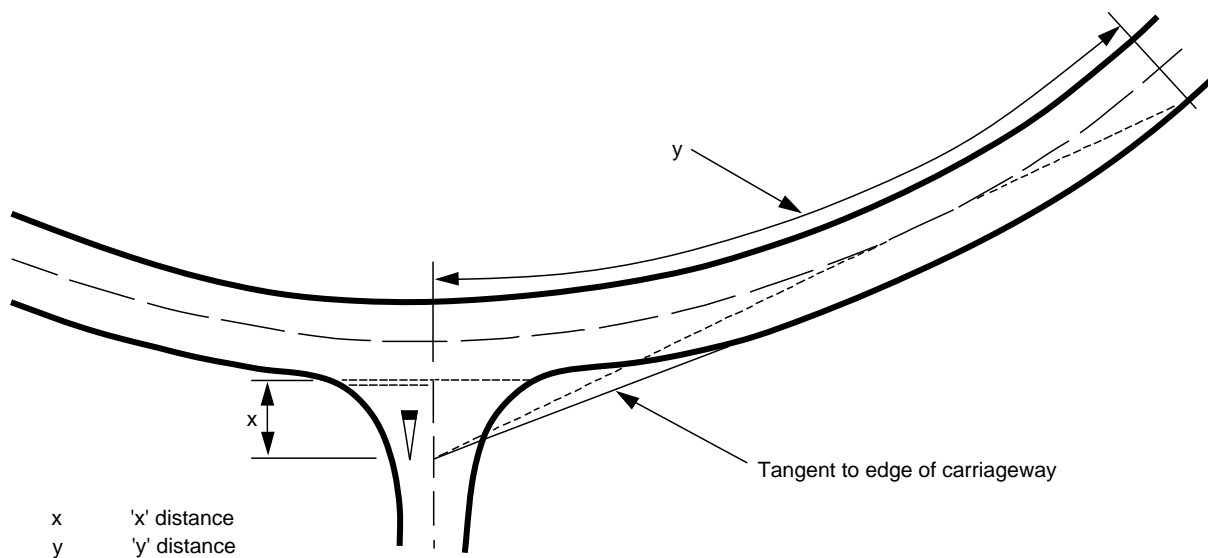

Figure 7/2 : Visibility Standards with a Curved Major Road (para 7.7)

7.8 In difficult circumstances, the 'x' distance may be taken as a Relaxation from 9.0m to 4.5m for lightly trafficked simple junctions, and in exceptionally difficult circumstances, to 2.4m back from the nearer edge of the major road running carriageway. The 'x' distance, from which full 'y' distance visibility is provided, shall not be more than 9m, as this induces high minor road approach speeds into the junction, and leads to excessive land take.

7.9 Similarly, although the 'y' distance shall always be provided, there is little advantage in increasing it, as this too can induce high approach speeds and take the attention of the minor road driver away from the immediate junction conditions. Increased visibility shall not be provided to increase the capacities of various turning movements.

7.10 These visibility standards apply to new junctions and to improvements to existing junctions.

7.11 Where the major road is a dual carriageway with a central reserve of adequate width to shelter turning traffic, the standard visibility splay to the left is not required, but the central reserve to the left of the minor road shall be kept clear of obstructions for the appropriate 'y' distance, when viewed from an 'x' distance of 2.4m.

7.12 If the major road is one way, a single visibility splay in the direction of approaching traffic will suffice. If the minor road serves as a one way exit from the major road, no visibility splays will be required, provided that forward visibility for turning vehicles is adequate.

7.13 Vehicles parked within splay lines may obstruct visibility. Where necessary, parking and access should be controlled to prevent this. Care should also be taken in the placing of signs, landscaping and street furniture within the visibility splay areas to ensure that their obstructive effect is minimal.

Design Vehicle

7.14 Allowance shall be made for the swept turning paths of long vehicles where they can reasonably be expected to use a junction. Consideration shall also be given to the manoeuvring characteristics of these vehicles in the design of staggered junctions.

7.15 All of the geometric parameters used in the design of a major/minor priority junction have been developed to cater for a 16.5m long articulated vehicle, whose turning width is greater than for most other vehicles within the normal dimensions permitted in the existing **Vehicle Construction and Use Regulations**, or likely to be permitted in the near future. The turning requirements of an 18.35m long drawbar trailer combination are less onerous regarding road width. In cases where hardstrips are present, the design vehicle is assumed to use these on some turns, and at some simple junctions, it may encroach into opposing traffic lanes.

7.16 However, a 15.5m long articulated vehicle with a single rear axle has been shown to be more onerous than the 16.5m long vehicle, but the small numbers of this type of vehicle currently operating in Great Britain mean that designing all junctions for such vehicles could be economically unjustifiable. Hence, if the major/minor priority junction being designed is in an area where there is likely to be regular use by such vehicles, the designer should take account of this either by amending the design to cater for such a vehicle, or by accepting that these vehicles may encroach into other traffic lanes, or overrun other areas. In such instances, consideration may be given to providing differential coloured or raised surfacing indicating the area of allowable overrun.

Corner Radii

7.17 Where no provision is made for large goods vehicles, it is recommended that the minimum circular corner radius at simple junctions should be 6m in urban areas and 10m in rural areas. Where provision is to be made for large goods vehicles, the recommended circular corner radius is:-

- a. 10m at urban simple junctions, followed by a taper of 1:5 over a distance of 30m, measured from the edge of the major road carriageway up the minor road in the case of the entry to the minor road, and followed by a similar taper measured from the centreline of the minor road along the major road for the entry to the major road.
- b. 15m at rural simple junctions, with tapers of 1:10 over a distance of 25m.
- c. 15m at ghost island junctions, with tapers of 1:6 over a distance of 30m.
- d. 15m at simple staggered junctions, with tapers of 1:8 over a distance of 32m.
- e. 20m radius in all other circumstances.

These radii only apply where there are no nearside diverge tapers or lanes, or nearside merge tapers. Figures for these are given in paras 7.54 and 7.61 respectively.

7.18 Where large goods vehicles comprise a significant proportion of the turning movements, use of the compound curve shown in Fig 7/3 is recommended.

Through Lanes

7.20 At ghost island junctions, the through lane in each direction shall not be greater than 3.65m wide, exclusive of hardstrips, but shall not be less than 3.0m wide.

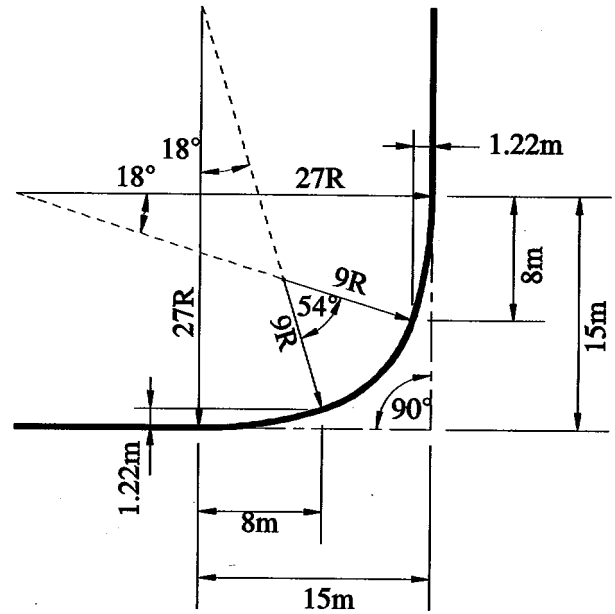

Figure 7/3 : Design of a Compound Curve (para 7.18)

Carriageway Widths

7.19 All of the geometric parameters defined in paras 7.20 - 7.48 can be seen for the three main types of major/minor priority junction in Figs 7/4, 7/5 and 7/6.

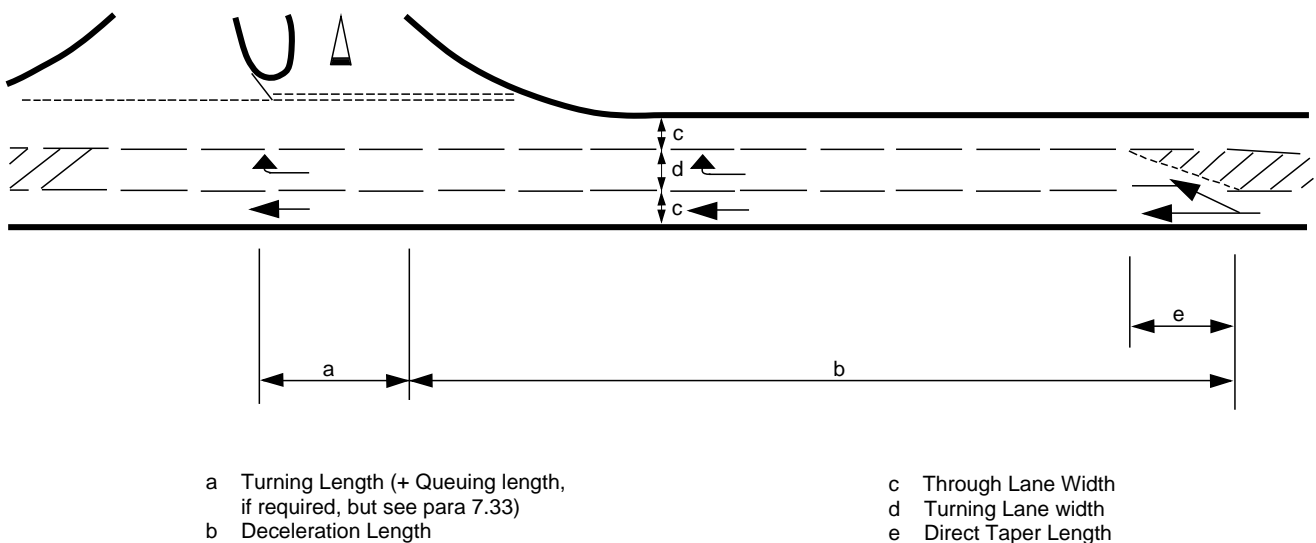

Figure 7/4 : Major / Minor Priority Junction with a Ghost Island (paras 7.20 - 7.48)

7.21 At single lane dualling junctions, the through lane in each direction shall be 4.0m wide exclusive of hardstrips. This width, with the hardstrips, will allow traffic to pass a stopped vehicle without leaving the paved width.

7.22 At dual carriageway junctions the through lane widths remote from the junction shall be continued through the junction.

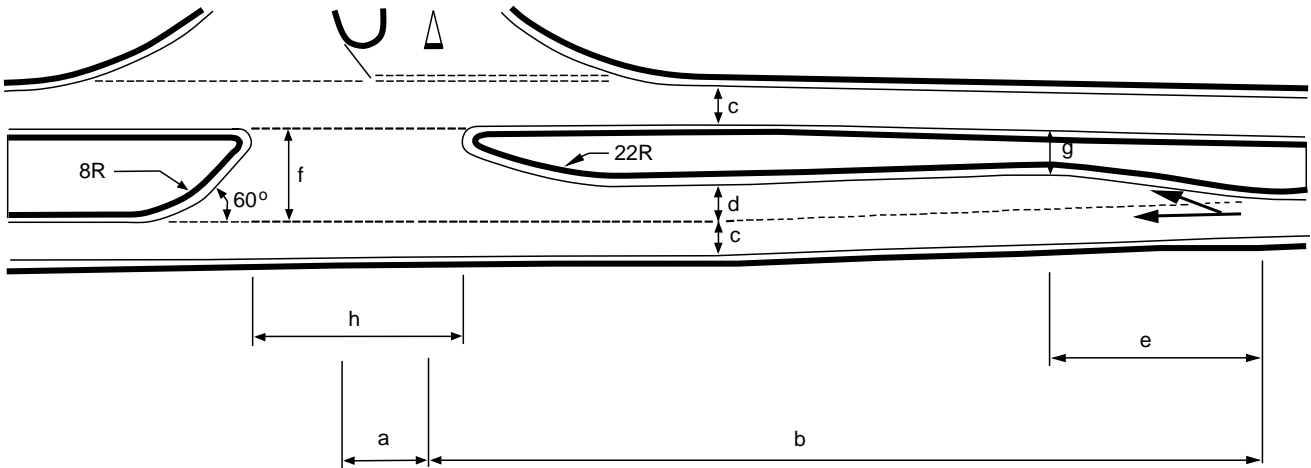

Figure 7/5 : Major / Minor Priority Junctions with Single Lane Dualling (paras 7.20 - 7.48)

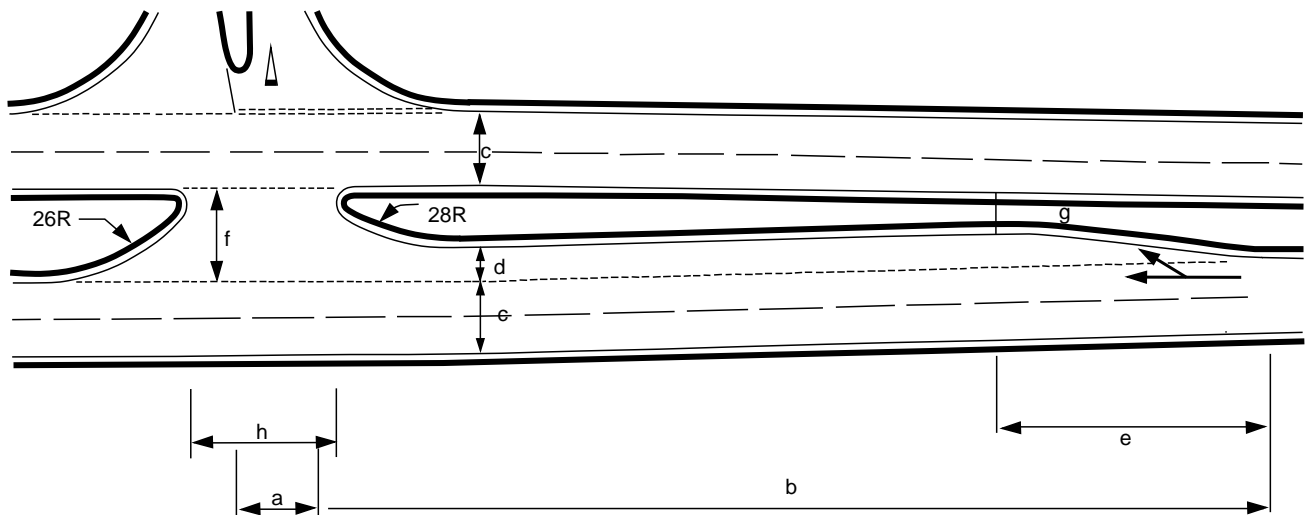

Figure 7/6 : Dual Carriageway Major/Minor Priority Junction (paras 7.20 - 7.48)

- | | | | |
|---|---|---|-------------------------------|
| a | Turning Length (+ Queuing Length, if required) | e | Direct Taper Length |
| b | Deceleration Length | f | Physical Island Width |
| c | Through Lane Width | g | Minimum Physical Island Width |
| d | Turning Lane Width | h | Central Reserve Opening |
- All radii shown in metres

Minor Road Approaches

7.23 On a minor road approach of nominal width 7.3m, where a channelising island, as described in Annex 2, is provided both lanes shall be 4.0m wide at the point where the hatched markings surrounding the channelising island begin. At the point where the channelising island commences, the widths on either side shall be as follows:-

a. On the approach to the major road, 4.0m

wide for a ghost island or 4.5m wide for single lane dualling or a dual carriageway, exclusive of hardstrips. If the approach on the minor road consists of two lanes, this dimension shall be 5.5m.

b. On the exit from the major road, 4.5m wide for a ghost island or 5.0m wide for single lane dualling or a dual carriageway, exclusive of hardstrips.

These dimensions are shown on Fig 7/7.

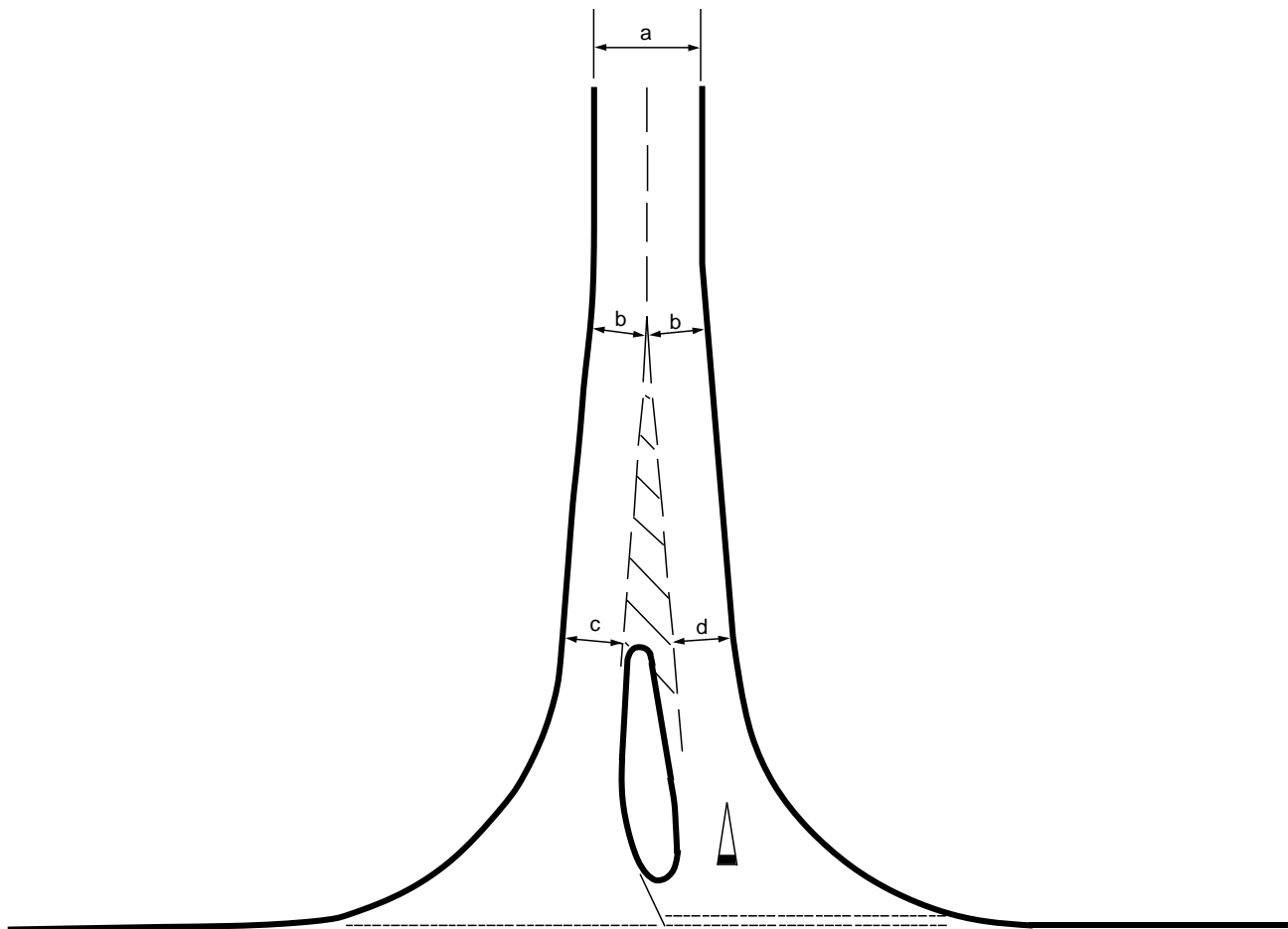

- a 7.3m nominal width
- b 4.0m in all cases
- c 4.5m for ghost island
5.0m for single lane dualling,
dual carriageway

- d 4.0m for ghost island
4.5m for single lane dualling,
dual carriageway
5.5m if two lane approach

Figure 7/7 : Minor Road Approaches (para 7.23 and Annex 2)

7.24 If there are no channelising islands in the minor road, the nominal approach width should continue up until the tangent point of the curve to join the edge of the major road running carriageway.

The width should be adequate to accommodate the swept paths of the vehicles being considered with an additional 1m allowance for variation in their position. Alternatively, figures from Table 7/2 could still be used.

Carriageway Widths around Curves

7.25 Where carriageways are taken around short radius corners, added width shall be provided to cater for the swept area of larger goods vehicles and the "cut in" of trailer units. On single lane sections greater than 50m in length an allowance shall be made for broken down vehicles as in para 7.21. Table 7/2 shows the recommended minimum widths for various nearside corner radii based on the design vehicle. For radii above 100m, the standards set out in **TD 9 (DMRB 6.1.1)** shall be used.

7.27 An articulated car transporter will turn in the widths shown, but where provision is to be made for this type of vehicle, street furniture above 2.5m high should be set back at least 1m from the edge of the minor road carriageway at the bellmouth (this does not apply for channelising islands) to allow for the projection of the trailer over the tractor cab.

Central Islands

7.26 Where 15.5m long vehicles are anticipated, but are likely to form only a very small percentage of the total number of vehicles and where conflicts will not occur on bends, the carriageway widths should be designed to cater for those lesser vehicles that will use the junction.

7.28 Cutting, merging and diverging movements can usefully be separated by physical or painted guide islands set out with road markings so that the number of traffic conflicts at any point is reduced (as indicated in Fig 7/10). Painted guide islands can be enhanced by the use of coloured surfacing or textures within them. However, designs which have numerous small traffic islands should be avoided as they are confusing and tend to be ignored.

Inside Corner Radius or Curve Radius (m)	Single Lane Width (excluding hardstrip provision) (m)	Single Lane Width with space to pass Stationary Vehicle (including hardstrip provision) (m)	Two Lane Width for One Way or Two Way Traffic (excluding hardstrip provision) (m)		
			Inside Lane	Outside Lane	Total
10	8.4	10.9	8.4	6.5	14.9
15	7.1	9.6	7.1	6.0	13.1
20	6.2	8.7	6.2	5.6	11.8
25	5.7	8.2	5.7	5.2	10.9
30	5.3	7.8	5.3	5.0	10.3
40	4.7	7.2	4.7	4.6	9.3
50	4.4	6.9	4.4	4.3	8.7
75	4.0	6.5	4.0	4.0	8.0
100	3.8	6.3	3.8	3.8	7.6

Table 7/2: Minimum Corner and Curve Radii and Carriageway Widths (para 7.25)

7.29 Preventing or minimising conflicts by separation means that drivers are only faced with simple decisions on their choices of movement at any one time. This can lead to greater safety. For the separation to be effective, the junction must be large enough for drivers to identify in adequate time those vehicles which will conflict with their intended path and those that will not. If this is not so, gaps in the flow cannot be used effectively by traffic entering the junction.

Tapers

7.30 Central islands, whether for ghost islands (Fig 7/8) or single lane dualling (Fig 7/9) should normally be developed symmetrically about the centreline of the major road to their maximum width at the tapers shown in Table 7/3. The maximum island width should continue through the junction to the tangent point of the minor road radius and the edge of the major road carriageway.

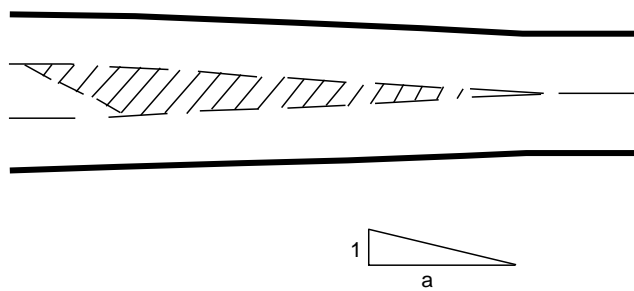

Figure 7/8 : Ghost Island Development and Taper (para 7.30)

For single lane dualling, the central island should be introduced by means of hatched markings until there is sufficient width to accommodate the appropriate sign on the nose of the physical island with the required running clearances to it.

7.31 Where junctions are located on climbing lane sections or on sharp curves, islands should be introduced asymmetrically to suit the circumstances (as indicated in Figs 7/16 and 7/17). It is perfectly permissible however, to introduce islands asymmetrically in other circumstances. This can have the benefit of avoiding expense (for example Statutory Undertakers' works). If the widening is biased to the minor road side, through traffic will be deflected where crossing movements at the minor road take place, which may be a benefit.

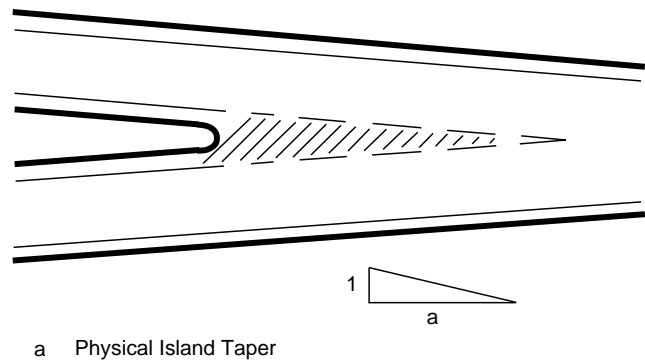

Figure 7/9 : Physical Island Development and Taper (para 7.30)

Design Speed (kph)	Taper for Ghost Island and Single Lane Dualling	Taper for Dual Carriageways
50	1:20	1:40
60	1:20	1:40
70	1:20	1:40
85	1:25	1:45
100	1:30	1:50
120	--	1:55

Table 7/3: Tapers for Central Islands

Turning Length

7.32 The turning length is provided to allow long vehicles to position themselves correctly for the right turn. The turning length shall be 10m long irrespective of the type of junction, design speed or gradient, measured from the centreline of the minor road. It is shown on Figs 7/4, 7/5 and 7/6.

7.33 Where capacity calculations indicate that for significant periods of time there will be vehicles queuing to turn right from the major road, the turning length shall be increased to allow for a reservoir queuing length to accommodate such vehicles. Where reservoir provision appears desirable at a junction with ghost islands, consideration shall be given to providing physical islands instead to afford greater protection to turning traffic. Where site conditions prevent this, the reservoir space may still be provided.

Direct Taper Length

7.34 The direct taper length is the length over which the width of a right turning lane is developed. For ghost islands and the physical islands in single lane dualling and dual carriageway junctions right turning lanes shall be introduced by means of a direct taper whose length is part of the deceleration length, and depends on the design speed. This taper length is given in Table 7/4.

Ghost Islands

7.35 For new junctions, the desirable width of a ghost island turning lane shall be 3.5m, but a Relaxation to 3.0m is permissible. At urban and suburban junctions it can sometimes be advantageous to use a greater width not exceeding 5.0m to allow a degree of shelter in the centre of the road for large goods vehicles turning right from the minor road to execute the turn in two separate manoeuvres. On rural roads, with design speeds above 85kph or where hardstrips are present, widths greater than 3.65m are inadvisable because wide ghost islands in these situations create a sense of space that could encourage hazardous overtaking at junctions.

7.36 For improvements to existing junctions where space is very limited a reduced width may be unavoidable. The width of ghost islands shall not be less than 2.5m.

7.37 At left/right staggered junctions, the deceleration lengths would overlap but the width of the ghost island shall not be increased to make them lie side by side. The starting points of the right turning section shall be joined by a straight line, which will mean at higher design speeds, the full width of the turning lane will not be developed until the end of the diverging section (as shown in Fig 8/3). The width of the turning lane shall be the full width of the ghost island.

Design Speed (kph)	Direct Taper Length (m)
50	5
60	5
70	15
85	15
100	25
120	30

Table 7/4: Direct Taper Length (para 7.34)

Width of Physical Islands in the Centre

7.38 At single lane dualling and dual carriageway junctions, the width of the central island at the crossing point shall be 10.0m, including central reserve hardstrips. This width will shelter most large goods vehicles turning right from the minor road, except for very long vehicles. In exceptional circumstances where use by very long vehicles is expected and a roundabout is not feasible, a width of 14.0m including hardstrips, will be needed to shelter the largest articulated vehicles (16.5m) and a width of 16.5m, including hardstrips, will be required to shelter drawbar trailer combinations (18.35m).

7.39 The minimum width of a physical island, usually located at the end of the direct taper shall be 3.5m (shown in Figs 7/5 and 7/6).

Right Turning Lanes

7.40 The overall length of a right turning lane provided at ghost island, single lane dualling and dual carriageway junctions, will depend on the major road design speed and the gradient. It consists of a turning length, as described in paras 7.32 and 7.33, and a deceleration length. This component shall be provided in accordance with Tables 7/5a and 7/5b, in which the gradient is the average for the 500m length before the minor road.

Design Speed (kph)	Up Gradient		Down Gradient	
	0-4%	Above 4%	0-4%	Above 4%
50	25	25	25	25
60	25	25	25	25
70	40	25	40	40
85	55	40	55	55
100	80	55	80	80
120	110	80	110	110

Table 7/5a: Deceleration Length (m) for Ghost Island and Single Lane Dualling (paras 7.40 and 7.55)

Design Speed (kph)	Up Gradient		Down Gradient	
	0-4%	Above 4%	0-4%	Above 4%
50	25	25	25	25
60	25	25	25	40
70	40	25	40	55
85	55	40	55	80
100	80	55	80	110
120	110	80	110	150

Table 7/5b: Deceleration Length (m) for Dual Carriageways (paras 7.40 and 7.55)

7.41 The deceleration length can be seen on Figs 7/4, 7/5 and 7/6. The deceleration lengths are based on the assumption that vehicles will slow by one design speed step on the trunk road before entering the length. The deceleration rate on the level is assumed to be 0.375g. There is no reaction time as this is a planned manoeuvre.

Central Reserve Openings

7.42 The opening in the central reserve for single lane dualling and dual carriageway junctions at the crossing point shall be 15.0m wide, as shown on Figs 7/5 and 7/6.

7.43 Problems have been experienced with driver confusion over priority within the central reserve, particularly where the width of the physical island has been increased to cater for large goods vehicles. Measures to regularise the priority arrangement within the central reserve opening include channelising the central area to arrive at a priority arrangement. An example is shown in Fig 7/10.

7.44 Consideration may also be given in these circumstances to introducing differential coloured surfacing to enhance the road markings or indicate the area of allowable overrun for large goods vehicles.

However, such coloured surfacing should also be visible at night and in poor weather conditions.

Traffic Islands and Refuges

7.45 Traffic islands should be provided in the mouth of the minor road at major/minor priority junctions, except simple junctions, to:-

- a. Give guidance to long vehicles carrying out turning movements.
- b. Channelise intersecting or merging traffic streams.
- c. Warn drivers on the minor road that a junction is ahead.
- d. Provide shelter for vehicles waiting to carry out manoeuvres such as waiting to turn right.
- e. Assist pedestrians.

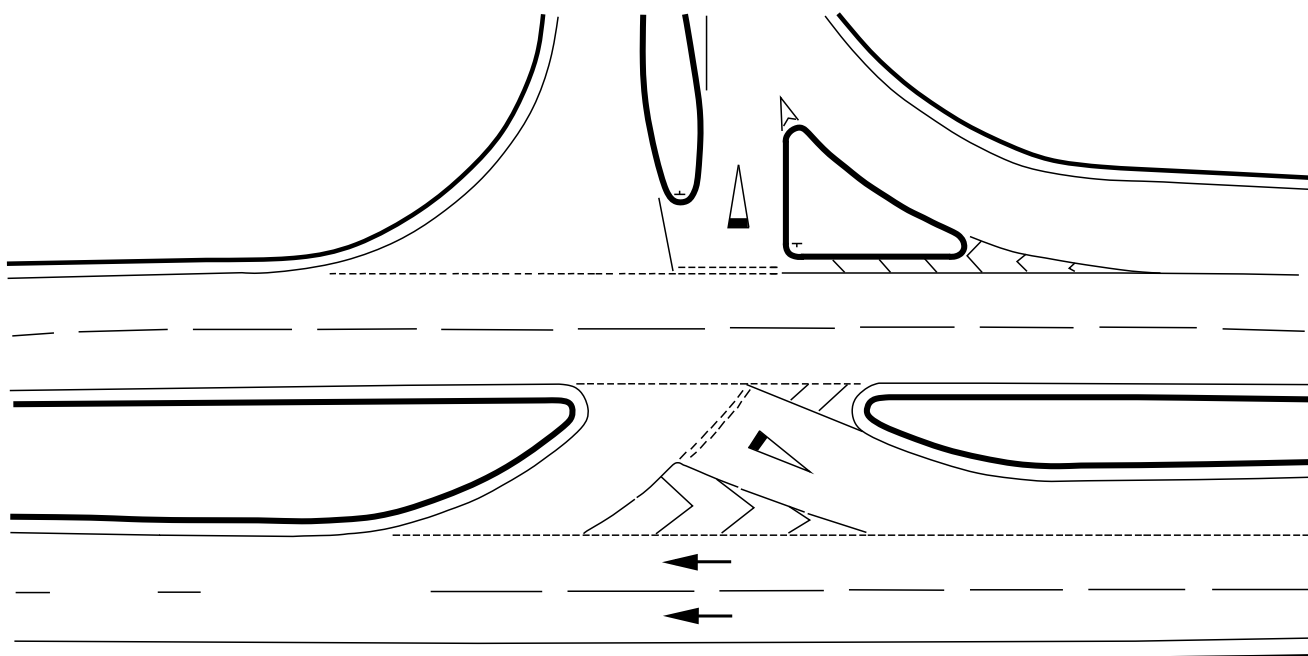

Figure 7/10 : Method of Regulating the Priority in the Central Reserve Opening
(paras 7.28, 7.43)

7.46 Physical islands shall have an area of at least 4.5 square metres, and shall be treated to be conspicuous in poor lighting conditions. Smaller areas should be defined by road markings. The risk of overriding the islands can be reduced by offsetting the approach nose from the edge of the vehicle paths.

7.47 Where a traffic island serves as a refuge for pedestrians it shall be at least 1.5m wide and have openings in the centre at carriageway level to make the crossing easier for pedestrians (see Fig 5/2). Opposite the refuge openings, dropped kerbs shall be installed for the same reason. A refuge beacon about 4-5m high may be placed between the bollards. Care shall be taken that street furniture does not obstruct the drivers' view of pedestrians.

7.48 The recommended layout and details of the design of rural channelising islands can be found in Annex 2.

Diverging Tapers and Lanes

7.49 Major road traffic, when slowing down on the approach to a junction in order to turn into a minor road, may impede the following vehicles that are not turning. It is helpful therefore to permit the divergence of the two streams at a small angle and approximately equal speed by the provision of a diverging taper.

7.50 Right turning tapers and lanes in the centre of ghost islands and single lane dualling on single carriageways, and on dual carriageways are especially useful as they provide a convenient space for vehicles to slow down and wait before turning off the major road, and assist the right turn out of the minor road. Details of the design of such facilities are covered in para 7.40.

7.51 Nearside diverging tapers allow left turning major road traffic to slow down and leave the major road without impeding the following through traffic, but they are of less benefit in terms of operation and safety than right turning lanes, possibly because the left turn from the major road does not cross an opposing traffic stream and is rarely impeded. However, nearside diverging tapers should always be considered for higher speed roads or on gradients.

7.52 Nearside diverging tapers shall not be provided at simple junctions (para 1.14). They shall be provided at junctions between "A" and "B" roads where the design speed for the A road is 85kph or above. They shall be provided at other junctions in the following circumstances for traffic in the design year:-

- a. Where the volume of left turning traffic is greater than 600 vehicles AADT.
- b. Where the percentage of large goods vehicles is greater than 20%, and the volume of left turning traffic is greater than 450 vehicles AADT.
- c. Where the junction is on an up or down gradient of greater than 4% at any design speed and the volume of left turning traffic is greater than 450 vehicles AADT.

Where the major road flow is greater than 7000 - 8000 AADT then the above figures for turning traffic can be halved. At some junctions there may be safety benefits in providing nearside diverging tapers at lower flows.

7.53 They shall not be provided where the minor road is on the inside of a curve where traffic on the diverging lane could adversely affect visibility for drivers emerging from the minor road. They shall generally not be provided where the design speed for the major road is less than 85kph nor where the cost of provision is excessive. In that case adequate warning of the junction ahead must be provided.

7.54 Nearside diverging tapers shall be formed by a direct increase to a width of 3.5m contiguous to the corner into the minor road (preferably of radius at least 20m where the main road design speed is 85kph and at least 40m above this speed). The width around this corner will depend on the radius selected. A "Give Way" line shall be provided so that the left turning traffic gives way to the traffic turning right from the major road. The length of this lane is defined as being from the beginning of the taper up to the "Give Way" line, as shown in Fig 7/11.

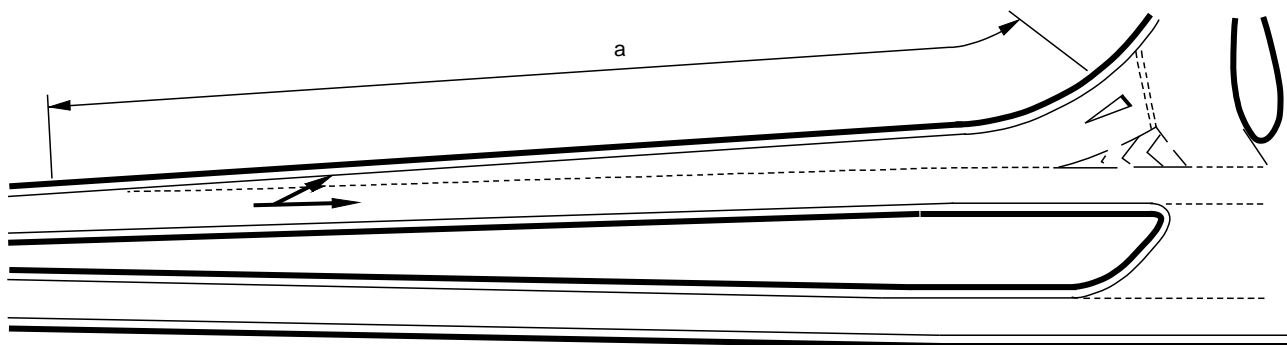

a Deceleration Length

Figure 7/11 : Major / Minor Priority Junctions with Nearside Diverging Taper (para 7.54)

7.55 The desirable length of a nearside diverging taper shall be that of the relevant deceleration length given in Tables 7/5a and 7/5b. Where there are severe site constraints this may be reduced by half as a Relaxation where the design speed is 85kph, but then a lane shall be at least 35m long.

7.56 At higher major road flows over 7000 - 8000 AADT, vehicles decelerating on the main carriageway and moving into the diverging taper to a point where there is a full lane width available in the diverging taper, may have a significant effect on the capacity of the through carriageway by impeding following drivers. In this instance, consideration should be given to the provision of a nearside auxiliary lane instead of a taper for diverging traffic. The provision of an auxiliary lane, as shown in Fig 7/12, would allow turning traffic to move off the mainline prior to any deceleration.

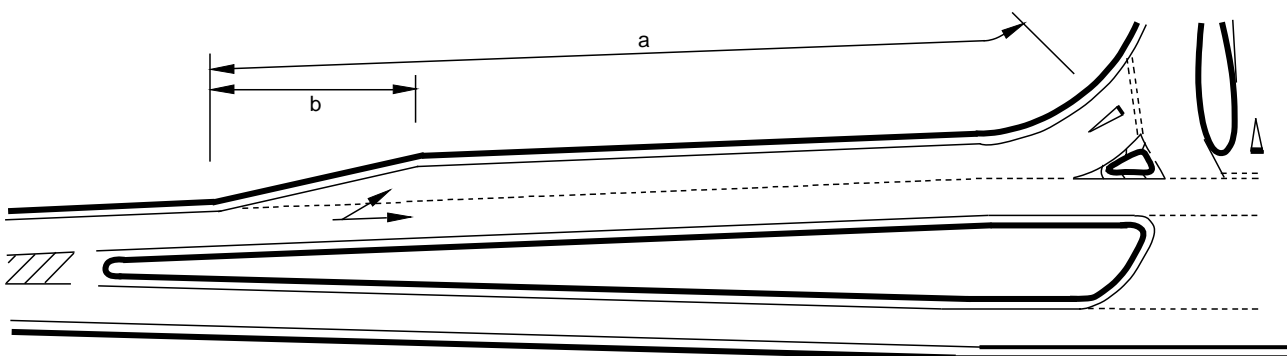

a Deceleration Length
b Direct Taper Length

Figure 7/12 : Major/Minor Priority Junction with Nearside Auxiliary Lane (para 7.56)

7.57 The auxiliary lane should be of sufficient length to allow for the speed change from the major road to the turn into the minor road and would not normally be less than 80m. Its length may also depend on any need for reservoir space for turning traffic. The auxiliary lane should commence with a direct taper (Fig 7/12) the length of which shall be determined from Table 7/4. The taper should be that used for a right turning lane for a single lane dualling or dual carriageway junction, with the relevant deceleration length given in Tables 7/5a and 7/5b.

Merging Tapers

7.58 Merging tapers permit minor road traffic to accelerate fully before joining the faster traffic streams on the mainline where the joining traffic may otherwise impede flow and be a source of hazard.

7.59 Merging tapers shall only be used at dual carriageway junctions. They shall be provided where a "B" road joins an "A" dual carriageway road having a design speed of 85kph or above. They shall be provided generally where the design speed is 85kph or above and the volume of left turning traffic in the design year exceeds 600 vehicles AADT. However, where the merging taper is for an upgradient of greater than 4%, or where the percentage of large goods vehicles exceeds 20% the threshold value may be reduced to 450 vehicles AADT. They shall never be used at single lane dualling junctions. They shall not be provided where the cost of provision would be excessive.

7.60 At some junctions on dual carriageways there may be safety benefits in providing merging tapers at lower flows.

7.61 A separate turning lane, preferably of radius at least 25m where the main road design speed is 85kph and at least 30m above this speed, shall be used to introduce the merging taper from the minor road. The initial width of the lane, which will depend on the radius of the turning lane determined from Table 7/2, should be decreased at a constant taper depending on the design speed (Fig 7/13).

7.62 The lengths of the tapers to be used are given in Table 7/6. The minimum initial width of a merging taper shall be 3.5m.

On dual carriageways with a design speed of 120kph the merging taper may be preceded by a short nose of 40m length formed between it and the end of the 30m approach curve as set out in para 7.61. The back of the nose should have a minimum width of 2m (Fig 7/14).

Design Speed (kph)	Merging Length (m)
85	90
100	110
120	130

Table 7/6: Merging Length

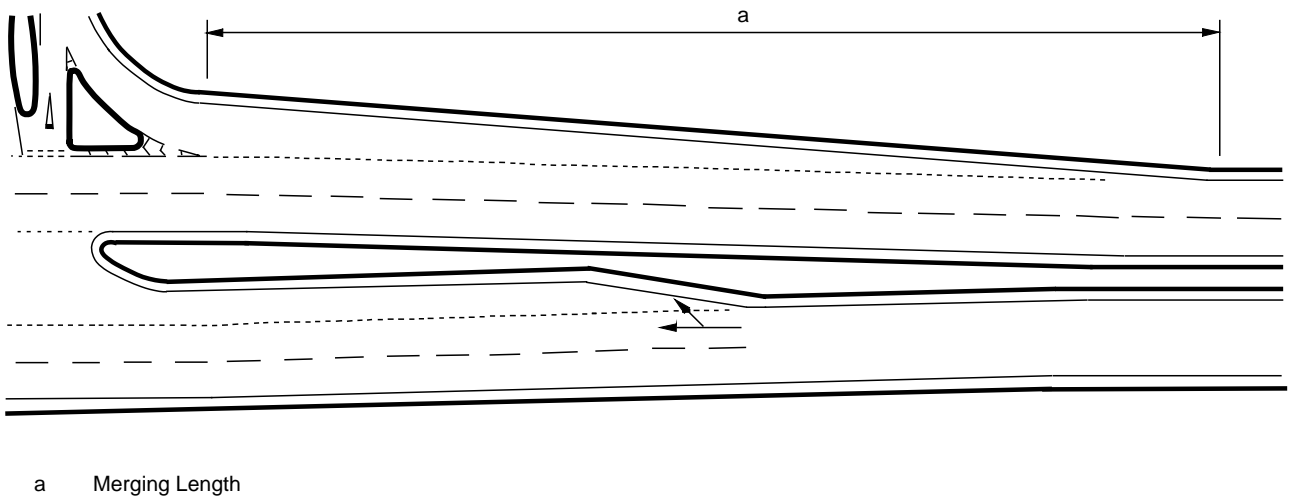

Figure 7/13 : Major / Minor Priority Junction with Nearside Merging Taper (para 7.61)

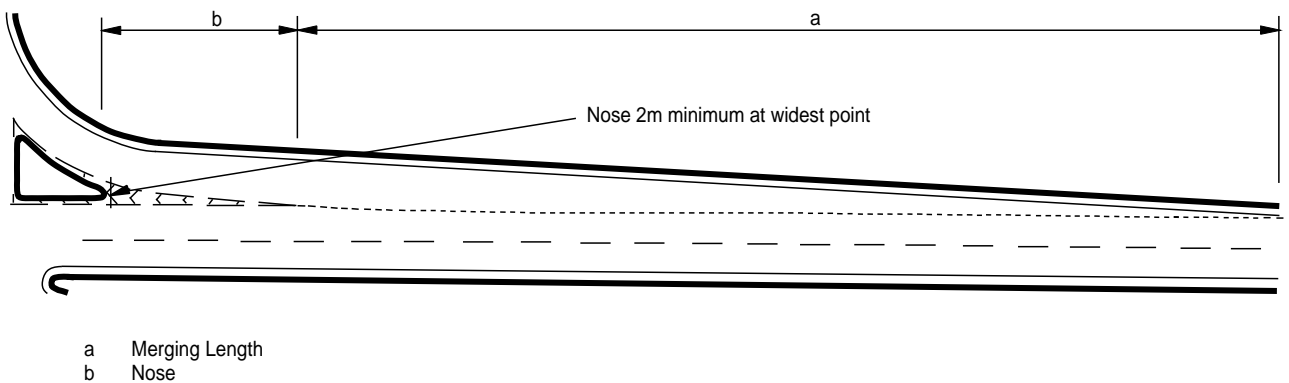

Figure 7/14 : Major/Minor Priority Junction with Nearside Merging Taper (para 7.62)
(Alternative for Dual Carriageway with a Design Speed of 120kph)

Stagger Distances

7.63 The stagger distance of a junction is the distance along the major road between the centrelines of the two minor roads.

7.64 For simple major/minor priority junctions with a right/left stagger, the minimum stagger distance shall be 50m. For a ghost island junction it shall also be 50m. For a junction with single lane dualling it shall be 40m, and for dual carriageways the distance shall be 60m. These are based on the distance required for manoeuvring the 18.35m drawbar trailer combination design vehicle between the two minor roads, and shall be provided on all new staggered junctions, including the upgrading of rural crossroads.

7.65 For simple left/right staggers, the minimum stagger distance shall be 50m. The minimum values for the other types of staggered major/minor priority junction are given in Table 7/7. For higher design speeds, this distance is based on the sum of the two deceleration lengths lying side by side plus the turning lengths (and queuing lengths, if appropriate) at each end, as indicated in the Table, otherwise it is based on the manoeuvring requirements of the design vehicle.

Skew Junctions

7.66 The design parameters where the minor road approaches at an angle other than 90°, for both left hand and right hand splay junctions, are shown in Fig 7/15. The parameters are set out in paras 7.20 - 7.48. For those locations where the major road is on a curve at the junction, the relevant design parameters are indicated in Fig 7/16.

Junctions on Climbing Lanes

7.67 For major/minor priority T-junctions located on a climbing lane, the key dimensions are shown in Fig 7/17.

7.68 Simple major/minor priority junctions and single lane dualling shall not be used within climbing lane sections, since problems of safety may arise.

7.69 Staggered junctions of other types shall be avoided on climbing lane sections. Both staggered junctions and climbing lanes on their own are situations requiring special driver concentration, and if provided in combination, the decisions required may be too confusing for some drivers.

Design Speed (kph)	Stagger Distance (m)		
	Ghost Island	Single Lane Dualling	Dual Carriageway
50	50 (manoeuvring)	--	60 (manoeuvring)
60	50 (manoeuvring)	--	60 (manoeuvring)
70	60 (10 + 40 + 10)	--	60 (manoeuvring)
85	75 (10 + 55 + 10)	75 (10 + 55 + 10)	75 (10 + 55 + 10)
100	100 (10 + 80 + 10)	100 (10 + 80 + 10)	100 (10 + 80 + 10)
120	--	--	130 (10 + 110 + 10)

Table 7/7: Minimum Stagger Distances for Left/Right Staggered Junctions

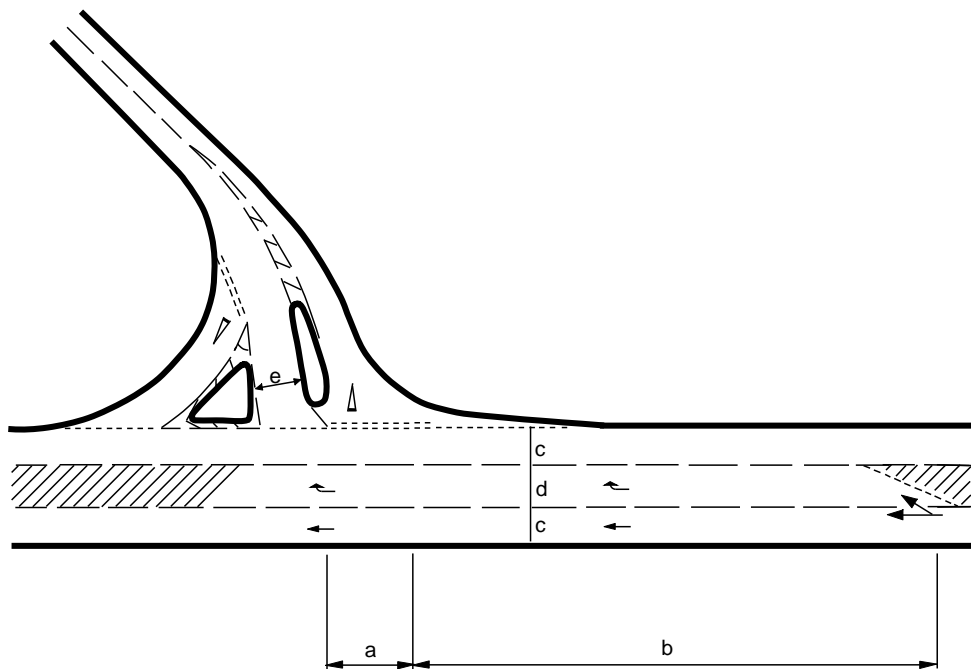
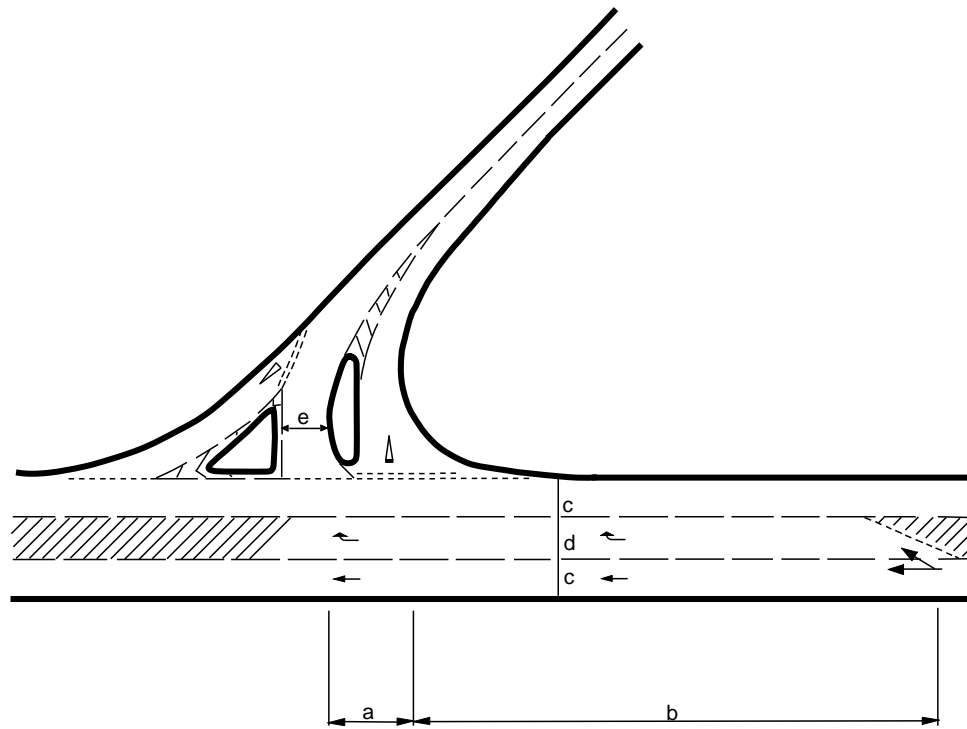

- | | | | |
|---|---------------------|---|------------------------|
| a | Turning Length | c | Through Lane Width |
| b | Deceleration Length | d | Turning Lane Width |
| | | e | Minor Road Entry Width |

Figure 7/15 : Major / Minor Priority Junction with Skew Minor Road
 (para 7.66)

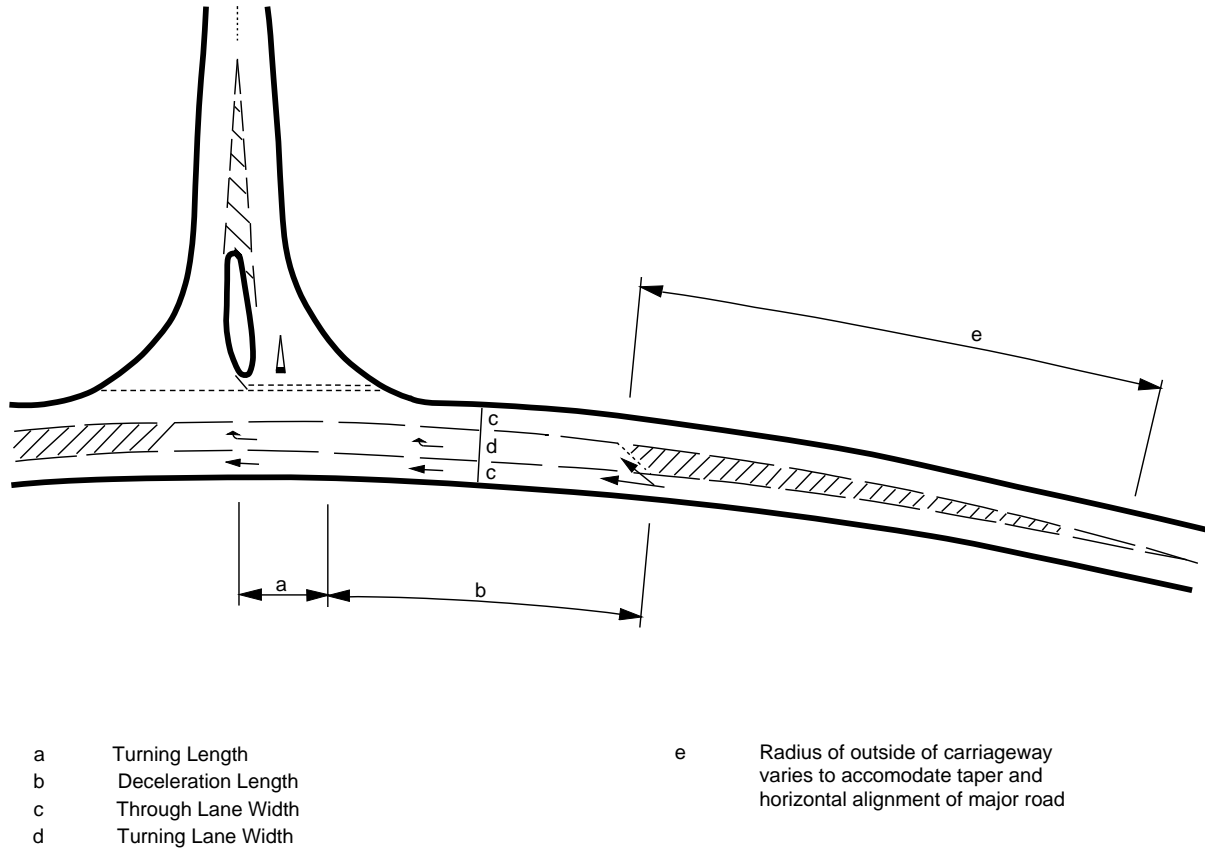
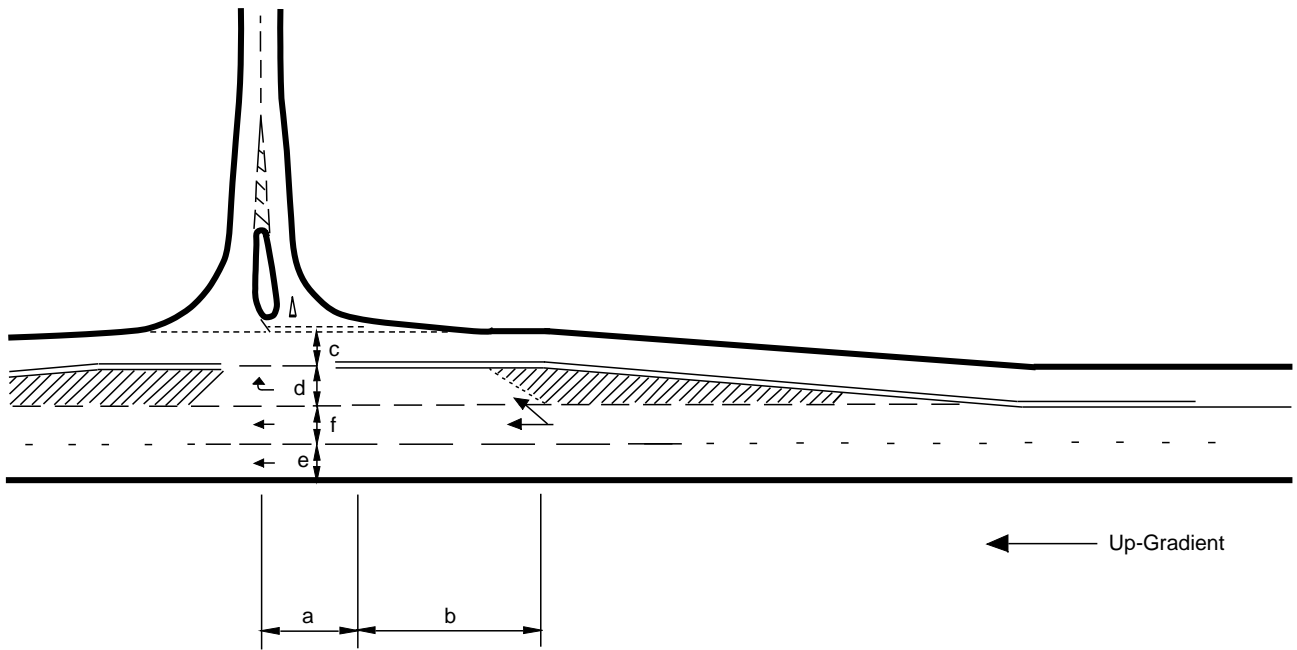
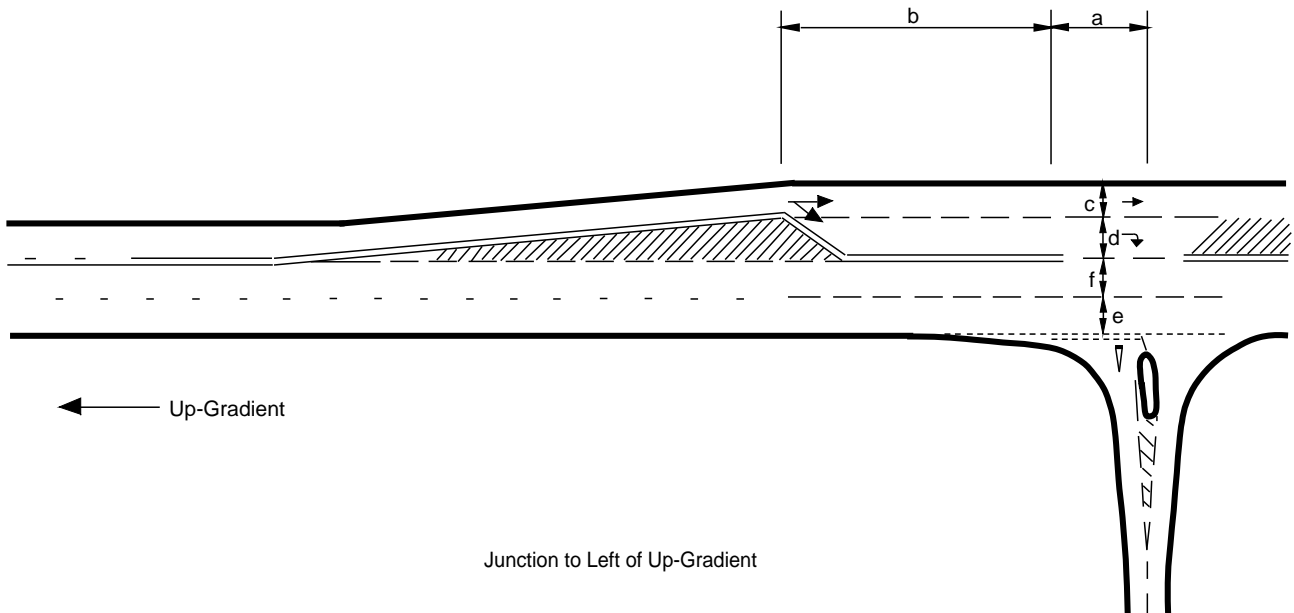

Figure 7/16 : Major / Minor Priority Junction with Curve on Major Road (paras 7.31, 7.66)



Junction to Right of Up-Gradient



Junction to Left of Up-Gradient

- | | | | |
|---|---------------------|---|--|
| a | Turning Length | d | Turning Lane Width |
| b | Deceleration Length | e | Climbing Lane Width |
| c | Through Lane Width | f | Climbing Lane Section Through Lane Width |

**Figure 7/17 : Major/Minor Priority Junction on a Climbing Lane
(paras 7.31, 7.67)**

Local Grade Separation

7.70 On dual carriageways where traffic moves at high speed or is heavy and continuous, it may be beneficial in terms of safety to prevent right turn crossing manoeuvres at the junction and to provide facilities nearby for turning traffic, as highlighted in para 4.3k. One method of achieving this is to provide a grade separated crossing, the principle of which is shown in Fig 8/4. The design of such crossings is outlined in the following paragraphs and the left in/left out connections to the mainline are illustrated in Figs 7/18 and 7/19.

7.71 Preventing right turns removes the need to increase the separation between the carriageways on the major road to cater for these movements. The major road carriageway can pass through the junction with an overall constant width. Two left in/left out connections are used with an overbridge or underpass. These junctions should be designed in composite form, as described in this chapter, catering for left turn movements only.

7.72 For the left turn merge to the main road, the minor road channelising island shown in Figs 7/18 and 7/19 shall be designed so as to provide a constant width of turn into the major road. The width shall be determined from Table 7/2. The detail of the island as approached along the minor road is as set out in Annex 2. If there is a merging taper as shown in Figs 7/13 and 7/19, the widths and tapers shall be as set out in paras 7.58 - 7.62. The hatched markings shall be extended from the minor road centreline to link with those for the merge taper, the channelising island being provided within them, as in Figs 7/18 and 7/19.

7.73 For the left turn diverge from the major road, the channelising island described in para 7.72 and shown in Figs 7/18 and 7/19 shall be designed so as to provide a constant width around the turn to the minor road. The width shall be determined from Table 7/2. Where a nearside diverging taper or nearside auxiliary lane is present (see Figs 7/11 and 7/12), the hatched markings should be extended along their current path until the intersection with the centreline of the minor road, and the channelising island shall be provided within them. This is shown in Figs 7/18 and 7/19.

7.74 This type of layout is a special form of major/minor priority junction, and can be used for either the design of new junctions, or for the upgrading of existing junctions. It is intended to be an alternative to either an at-grade major/minor priority junction and a fully graded separated junction as detailed in **TD 22 (DMRB 6.2.1)**. The left in/left out connections can also be used with the compact grade separation set out in **TD 40 (DMRB 6.2)** which offers a cheaper but more restricted form of grade separation where the economic case is not as strong.

7.75 The connector roads between the left in/left out connections shall be designed in accordance with **TD 9 (DMRB 6.1.1)** where grade separation with a greater capacity is required than that available with the compact form described in **TD 40 (DMRB 6.2)**.

Drainage and Crossfall

7.76 From considerations of surface water drainage and driver comfort, the road camber on the major road shall be retained through the junction and the minor road graded into the channel line of the major road. Checks shall be made for flat areas at all changes of gradient, superelevation or crossfall.

Traffic Signs and Road Markings

7.77 The need for, and layout of, traffic signs and road markings is an integral part of the design process and no junction design is complete without these features having been included. Advance direction and warning signs shall be provided, and care must be taken with the positioning and size of signs at the junction itself so that they do not interfere with drivers' visibility requirements. These matters need to be considered from the earliest stage as they can fundamentally affect layout and hence land acquisition requirements. Advance signing on minor roads may need particularly careful consideration.

7.78 The policy and detailed guidance on these aspects are given in the **Traffic Signs Manual**, and reference shall always be made to the Manual for comprehensive advice.

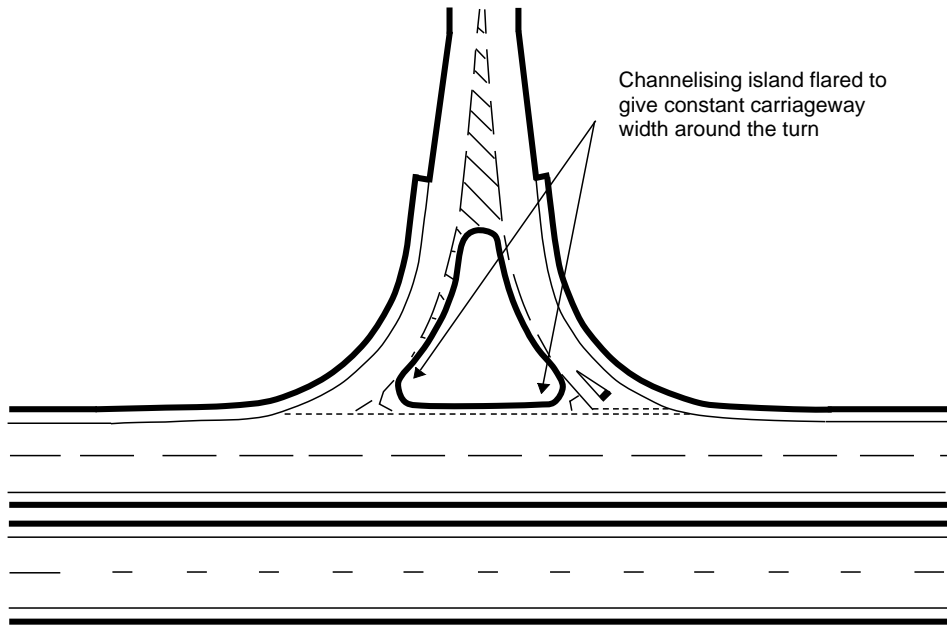
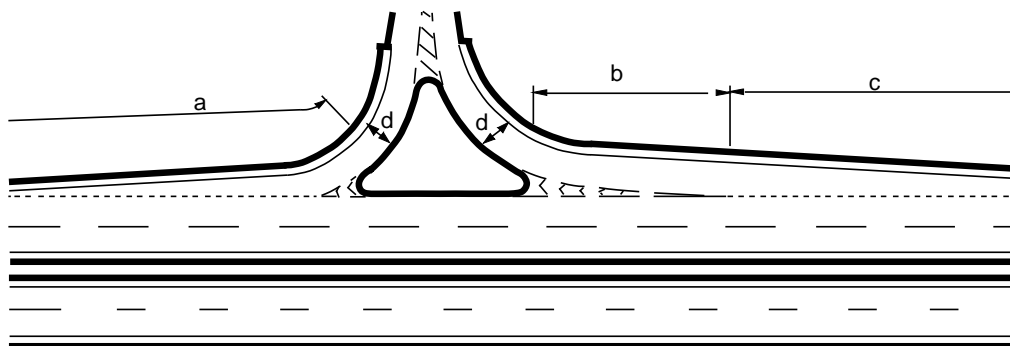

Figure 7/18 : Local Grade Separation T-Junction (para 7.70)



- a Diverge Taper
- b Nose
- c Merge Taper
- d Curve Widened Lane

Figure 7/19 Local Grade Separation T - Junction (Alternative for Dual Carriageway with a Design Speed of 120 kph) para 7.70

Road Lighting

7.79 Road lighting is normally provided at major/minor priority junctions in rural areas only when an intersecting road has lighting. When an existing

junction is being modified, the lighting provision should be checked for suitability with the new arrangement. Any alteration should be carried out prior to, or at the same time as the roadworks.

8. ASSEMBLY OF DESIGN ELEMENTS

8.1 The overall aim in designing a major/minor priority junction shall be to provide drivers with layouts that have consistent standards and are not likely to confuse them. Wherever practicable, the layout shall be designed so as to follow the traffic pattern, with the principal movements being given the easiest paths. This improves the smoothness of operation and makes it more readily understood by drivers. Unduly sharp radii or complex paths involving several changes in direction shall be avoided.

8.2 In Chapter 7, the components of design have been considered separately, but the final layout shall be looked at as a whole. It is important that, on entering a junction, drivers should be able to see and understand, both from the layout and advance traffic signs, the path they should follow, and the likely actions of crossing, merging and diverging vehicles.

8.3 Figs 8/1 - 8/4 show how the component parts can be assembled to produce the overall junction design.

8.4 The designer shall aim to achieve the best balance between the design components in order that the overall junction works safely and efficiently, as described in para 8.1. The final assessment of the design of a major/minor priority junction can only be carried out when looking at the junction both as a whole, and in the context of those links and junctions adjacent to it on a particular route. The designer shall consider the design from all the potential road users' point of view and trace through the possible movements. In particular, the demands placed on the driver using the junction shall be considered bearing in mind what preceded arrival at the junction and what will follow. It is important in particular to determine what will actually be visible to the driver as they approach the junction. This is what is termed the "driveability" objective in design.

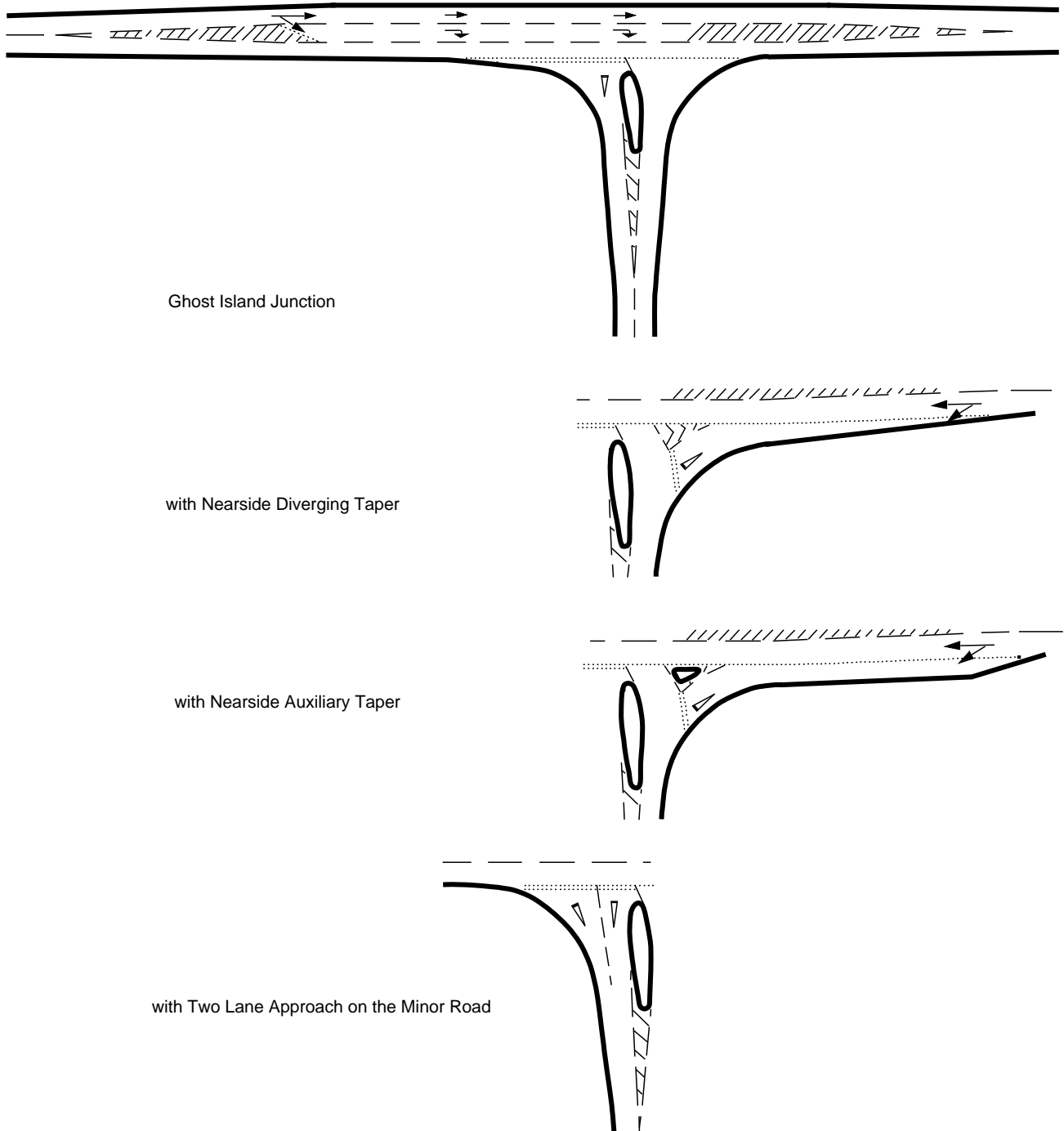

Figure 8/1 : Assembly of Components to Form Single Carriageway T-Junctions

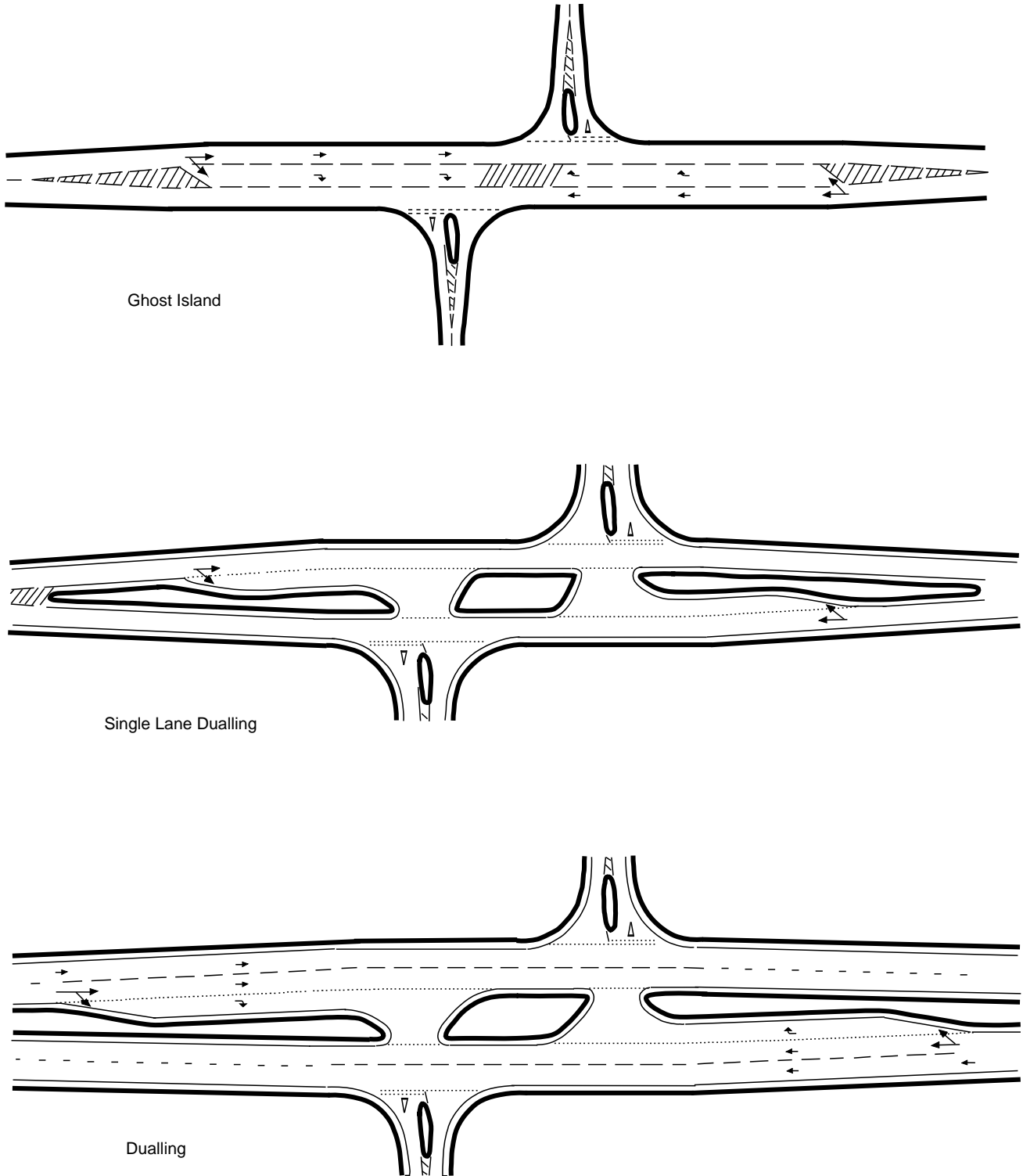

Figure 8/2 : Alternative Right / Left Staggered Junctions

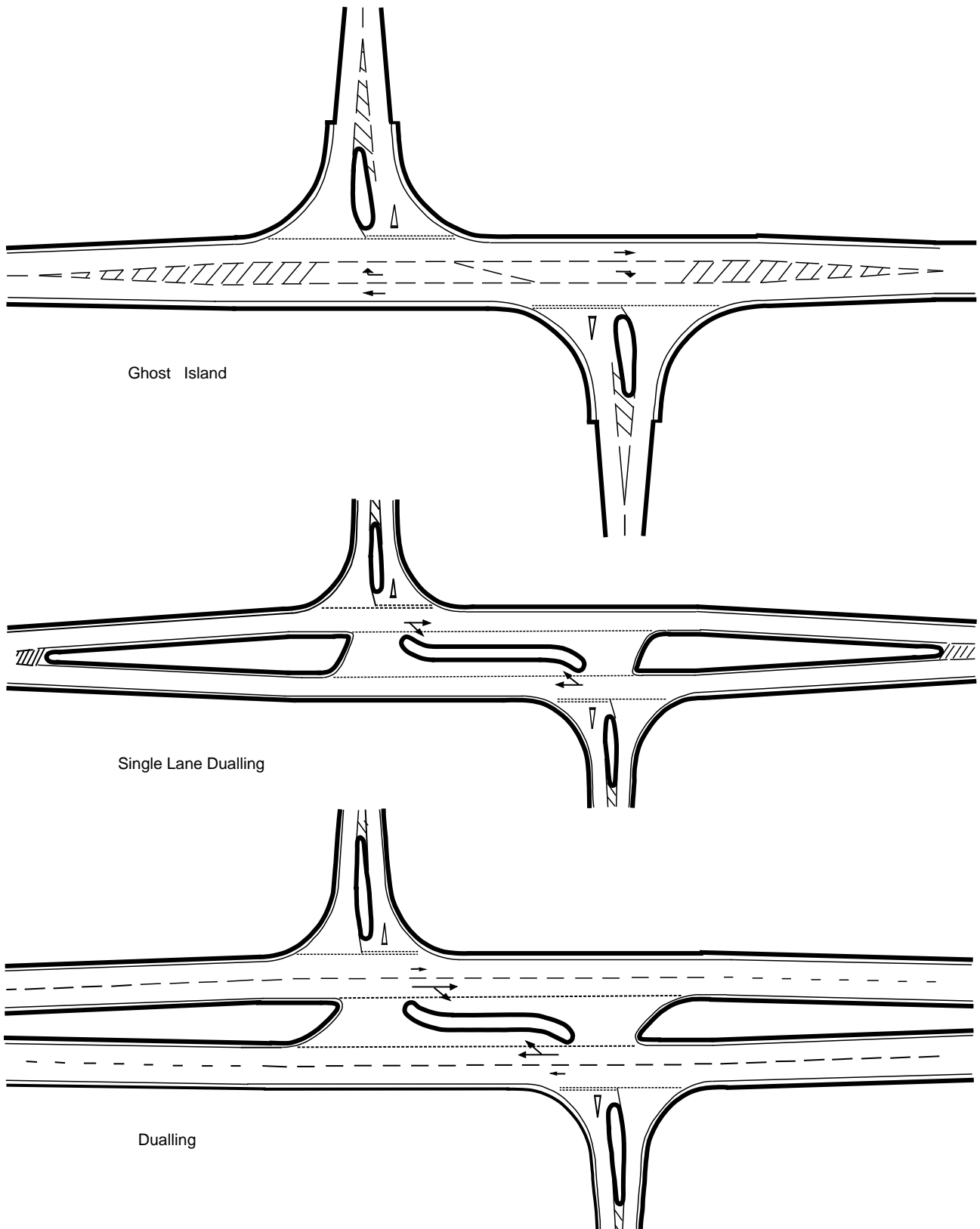
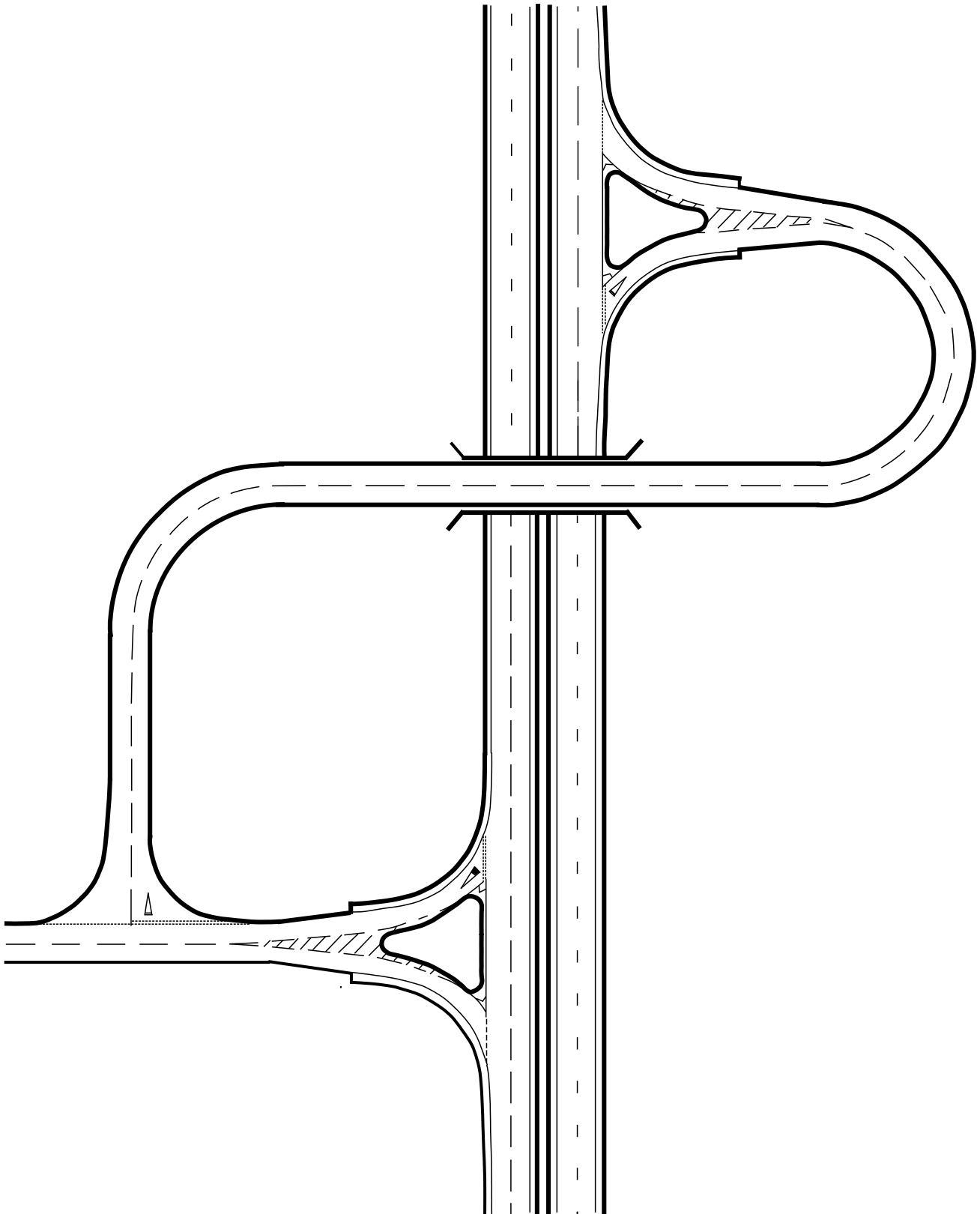

Figure 8/3 : Alternative Left / Right Staggered Junctions



For junctions with Nearside Diverging Taper on main line see Fig 7/11 and Fig 7/19
For junctions with Nearside Merging Taper on main line see Fig 7/13 and Fig 7/19

Figure 8/4 : Local Grade Separation

9. REFERENCES

Design Manual for Roads and Bridges

- a). Design Manual for Roads and Bridges, Volume 2 Highway Structures: Design (Substructures and Special Structures), Materials, Section 2 Special Structures, BD 29 (DMRB 2.2) Design Criteria for Footbridges.
- b). Design Manual for Roads and Bridges, Volume 5 Assessment and Preparation of Road Schemes, Section 1 Assessment of Road Schemes, TA 30 (DMRB 5.1) Choice between Options for Trunk Road Schemes.
- c). Design Manual for Roads and Bridges, Volume 6 Road Geometry, Section 1 Links, Part 1, TD 9 (DMRB 6.1.1) Highway Link Design.
- d). Design Manual for Roads and Bridges, Volume 6 Road Geometry, Section 2 Junctions, TA 23 (DMRB 6.2) Determination of the Size of Roundabouts and Major/Minor Junctions.
- e). Design Manual for Roads and Bridges, Volume 6 Road Geometry, Section 3 Highway Features, Part 1, TD 36 (DMRB 6.3.1) Subways for Pedestrians and Pedal Cyclists. Layout and Dimensions.
- f). Design Manual for Roads and Bridges, Volume 6 Road Geometry, Section 3 Highway Features, TA 57 (DMRB 6.3) Roadside Features.
- g). Design Manual for Roads and Bridges, Volume 8 Traffic Signs and Lighting, Section 5 Pedestrian Crossings, TD 28 (DMRB 8.5) Pedestrian Crossings: Pelican and Zebra Crossings.
- h). Design Manual for Roads and Bridges, Volume 8 Traffic Signs and Lighting, Section 5 Pedestrian Crossings, TA 52 (DMRB 8.5) Design Considerations for Pelican and Zebra Crossings.
- i). Design Manual for Roads and Bridges, Volume 10 The Good Roads Guide.

Traffic Signs Regulations

- a). SI 1994 No 1519 - The Traffic Signs Regulations and General Directions 1994: HMSO.
- b). Traffic Signs Manual: HMSO

Local Transport Notes

- a). Local Transport Note 1/86 Cyclists at Road Junctions and Crossings.
- b). Local Transport Note 2/86 Shared Use by Cyclists and Pedestrians.

Miscellaneous

- a). Road Accidents in Great Britain 1991.
- b). TRL Report RR 65. Accidents at Rural T-Junctions.
- c). Accident Investigation and Prevention Manual.
- d). Road Vehicle (Construction and Use) Regulations 1986.

10. ENQUIRIES

All technical enquiries or comments on this document should be sent in writing as appropriate to:-

The Civil Engineering and
Environmental Policy Director
Highways Agency
St Christopher House
Southwark Street
London SE1 0TE

T A ROCHESTER
Civil Engineering and
Environmental Policy Director

The Deputy Chief Engineer
The Scottish Office Industry Department
Roads Directorate
New St Andrew's House
Edinburgh EH1 3TG

N B MacKENZIE
Deputy Chief Engineer

The Director of Highways
Welsh Office
Y Swyddfa Gymreig
Government Buildings
Ty Glas Road
Llanishen
Cardiff CF4 5PL

K J THOMAS
Director of Highways

Chief Engineer - Roads Service
Department of the Environment for
Northern Ireland
Road Service Headquarters
Clarence Court
8 - 10 Adelaide Street
Belfast BT2 8GB

W J McCOUBREY
Chief Engineer - Roads Service

CALCULATION OF CAPACITY

1. The formulae for capacity calculation for major/minor priority junctions evaluate flows, allowing for any conflict between the various traffic streams. The computer program PICADY/3 has been developed to carry out these calculations and evaluate queues, delays and, in some cases, predict accident rates. Major/minor priority junction flows, some of which are intermittent turning movements, are considered to be at "capacity" when there is continuous queuing feeding a particular turning movement. Not all movements need be at "capacity" for the junction to be considered at "capacity".

2. The equations for the prediction of possible minor road entry flows into a major/minor priority junction are a function of the through flow and entry geometry at the junction. These equations are applicable to all types of major/minor priority T-junctions, including staggered junctions. Having developed a range of Design Reference Traffic Flows, a designer should use the equations to produce trial designs for assessment. Manual or computerised methods such as PICADY/3 may be used. However, it is not realistic to calculate queue lengths and delays manually.

Ratio of Flow to Capacity

3. The ratio of flow to capacity (RFC) is an indicator of the likely performance of a junction under design year loading. It should be calculated or computed for each trial design. Due to site to site variation, there may be a standard error of prediction of the entry capacity by the formulae of + or - 15% for any site. Thus, queuing should not occur in the various turning movements in the chosen design year peak hour in 5 out of 6 peak hour periods or sites, if a maximum RFC of about 85% is used. Similarly, if a maximum RFC of 75% is used, queuing will theoretically be avoided in 39 out of 40 peak hour periods or sites.

4. The general use of designs with an RFC of about 85% is likely to result in a level of provision which will be economically justified. However, at sites having no particular space restriction, and also where the Design Speed may be 100kph or more, usually in suburban and rural areas, the latter ratio, 75%, should be used as a design yardstick. This is because the formulae have not been derived for roads of this type. In urban areas, the former RFC, 85%, may be appropriate.

5. Right turning queues and delays in the minor road should be virtually avoided in practice by use of the 75% RFC. The loss of Net Present Value (NPV) on a typical road scheme containing major/minor priority junctions by using the 75% factor instead of the 85% may be relatively small in marginal cases where, for instance, the option between a ghost island and the next upward step in the hierarchy, single lane dualling, is being investigated. Nevertheless, this sort of comparison should be set down in the overall framework of design.

6. Designers should not strive to obtain a unique value. A range of situations must be considered and the advantages and disadvantages of each one assessed.

Variation

7. It must be stressed that the calculated capacities, queues and delays are average values of very broad distributions. The formulae used are based on multiple regression analyses from observations from a large number of sites. Actual values can vary about the average due to:-

Site to site variation.

Day to day variation.

Site to site variation has been estimated, and is covered by the procedures. As far as day to day variation is concerned, this will manifest itself in practice as variations in the queue lengths and delays at any given time in the peak period. The formulae merely calculate the average over many days. PICADY/3 offers daily variability calculations as well as averages.

Annex 1

Prediction of Turning Stream Capacities

8. The best predictive equations for turning stream capacities, for major roads with Design Speeds of up to 85kph, found by research to date are, with reference to Fig A1/1:-

$$q_{b-a}^s = D(627 + 14W_{cr} - Y[0.364q_{a-c} + 0.144q_{a-b} + 0.229q_{c-a} + 0.520q_{c-b}])$$

$$q_{b-c}^s = E(745 - Y[0.364q_{a-c} + 0.144q_{a-b}])$$

$$q_{c-b}^s = F(745 - 0.364Y[q_{a-c} + q_{a-b}])$$

where $Y = (1 - 0.0345W)$

In each of these equations, the geometric parameters represented by D, E and F are stream specific:-

$$D = (1 + 0.094[w_{b-a} - 3.65])(1 + 0.0009[V_{r_{b-a}} - 120])(1 + 0.0006[V_{l_{b-a}} - 150])$$

$$E = (1 + 0.094[w_{b-c} - 3.65])(1 + 0.0009[V_{r_{b-c}} - 120])$$

$$F = (1 + 0.094[w_{c-b} - 3.65])(1 + 0.0009[V_{r_{c-b}} - 120])$$

Where w_{b-a} denotes the lane width available to waiting vehicles in the stream B-A, and $V_{r_{b-a}}$, $V_{l_{b-a}}$ the corresponding visibilities, and so on. In all cases, capacities and flows are in pcu/hour and distances in metres. If the right hand side of any equation is negative, the capacity is zero.

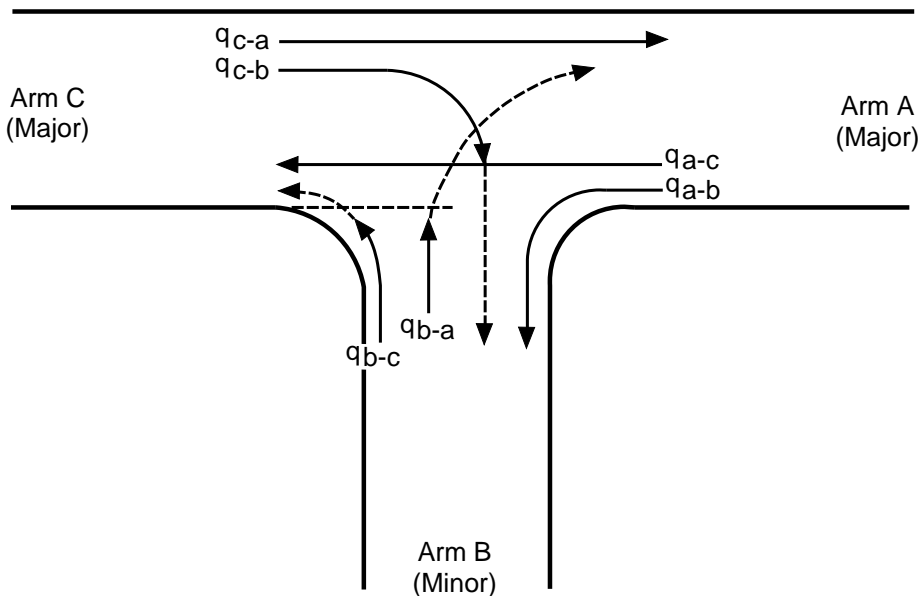

Notes

q_{c-a} = the flow of vehicles for the stream c-a

q_{b-a} = the flow of vehicles for the stream b-a

and so on

Superscript ^s (eg q_{b-a}^s) denotes the flow from a saturated stream, ie one in which there is stable queueing

Figure A1/1 : Definition of Turning Stream Capacities

9. Visibilities are measured as detailed in Chapter 7 of the main document. W , W_{cr} and w are measured as follows:-

$$W_n = \frac{1}{2} (W_2 + W_4) \quad \text{and} \quad W_f = \frac{1}{2} (W_1 + W_3)$$

a. The major road width, W , has two main components, the "nearside" width, W_n , and the "farside" width, W_f , which are added together to give the total carriageway width. With reference to Fig A1/2,

b. At dual carriageway sites with a kerbed central reserve, the width of the central reserve, W_{cr} is

$$W_{cr} = \frac{1}{2} (W_5 + W_6)$$

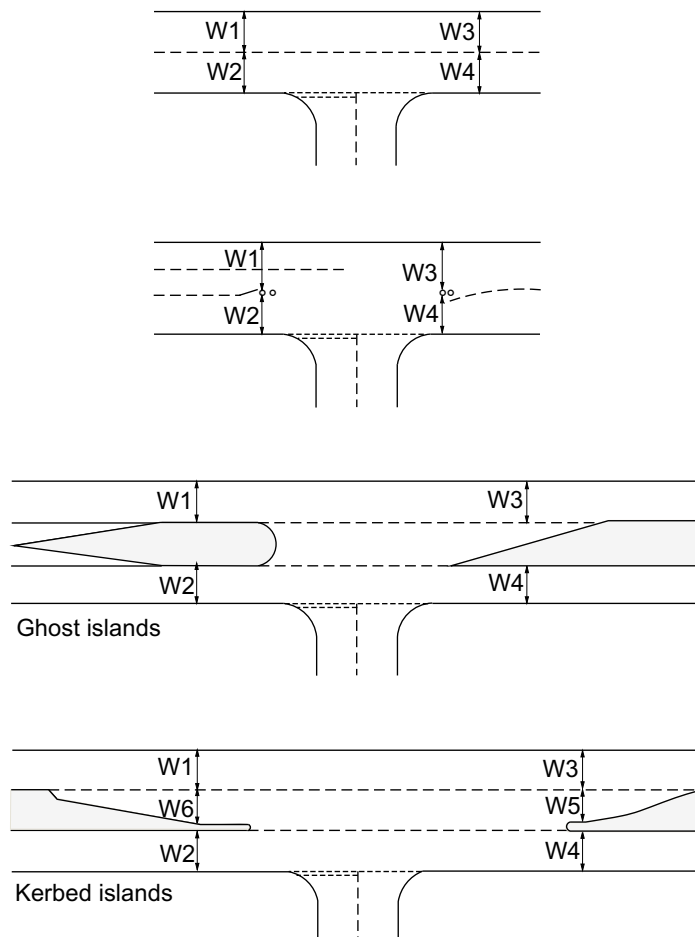

Figure A1/2 : Lane Width Measurement for Major Road

c. The lane width for non-priority streams, w , is measured directly where there are clear lane markings. The average of measurements taken at 5m intervals over a distance of 20m upstream from the Give way line is used. Any measurement exceeding 5m is reduced to 5m before the average is taken. Where lane markings are either unclear or absent,

reference should be made to Fig A1/3, and the lane width calculated according to:-

$$w = \frac{1}{5} (a + b + c + d + e)$$

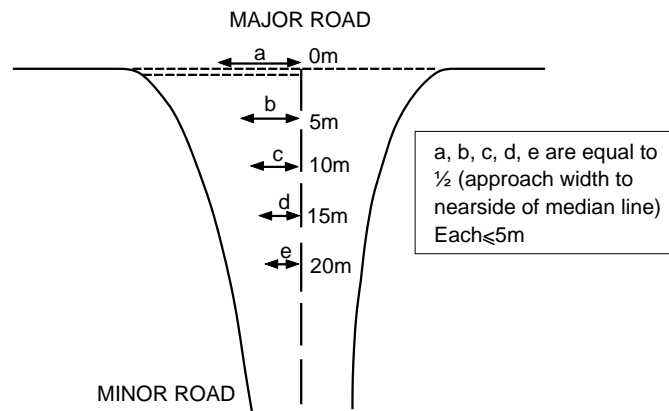

Diagram (a) Lane width measurements for the right-turning minor road stream

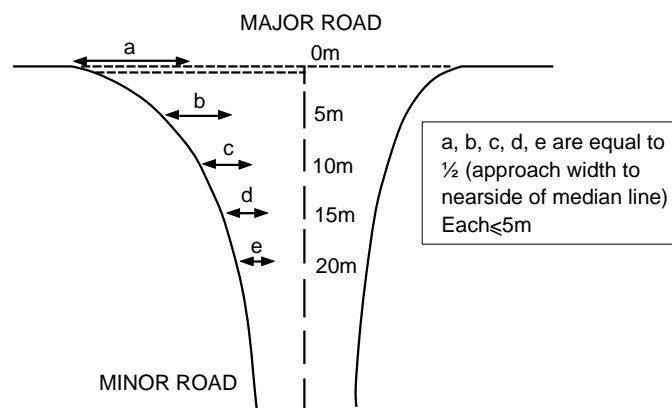

Diagram (b) Lane width measurements for the left-turning minor road stream

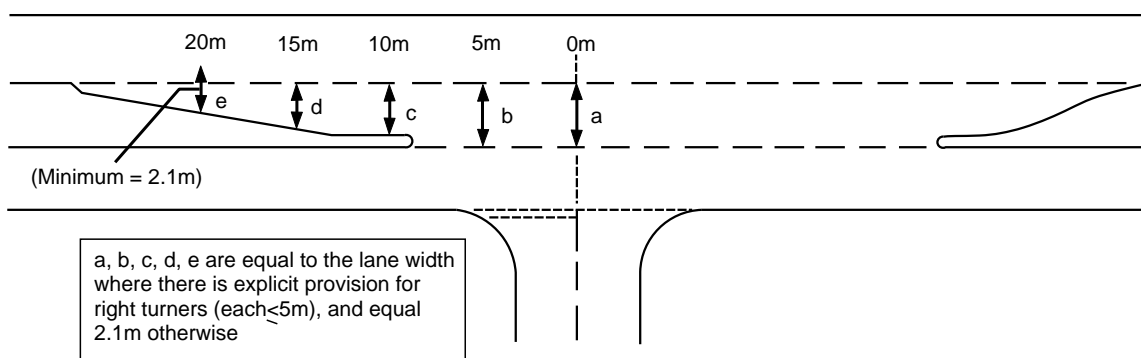

Diagram (c) Lane width measurements for the right-turning major road stream

Figure A1/3 : Lane Width Measurements for Non-Priority Streams

Manual Calculation

10. Using the formulae the RFCs of the various turning movements should be examined. The Design Reference Flows should be multiplied by 1.125 to allow for short term variations in traffic flows. Short term variation is included in PICADY/3. The standard error of capacity prediction due to variation between sites is 13%.

Computerised Calculation

11. A computer program such as PICADY/3 should be used. The appraisal should normally be based on an RFC of about 85% in urban areas or 75% in rural areas. In calculating this, a time segment length of not less than 5 minutes should be used to build up the flow pattern during the peak. The program prints out the RFC (labelled Demand/Capacity in the output), queue lengths and delays for each turning movement, for each time segment.

Ranges of Factors

12. For the purpose of manual or computerised calculation of turning stream capacities, the practical ranges of the geometric parameters defined above are given in Table A1/1.

The maximum values used for central reservation width and visibilities should be 10m and 250m respectively, even if it is proposed to provide physically greater values when the junction is constructed.

13. An example of a typical calculation follows.

Parameter		Practical Range
w	lane width for non-priority streams	2.05 - 4.70m
V _r	visibility to the right	17.0 - 250.0m
V _l	visibility to the left	22.0 - 250.0m
W _{cr}	width of central reserve	1.2 - 9.0m
W	major road width	(dual carriageway sites only) 6.4 - 20.0m

Table A1/1: Range of Parameters for Capacity Formula

Annex 1

Example

1. It has been decided to construct a major/minor priority junction at the T-junction between two S2 roads. The major road is an inter-urban road (Design Speed 100kph) which is expected to have a typically inter-urban seasonal variation pattern.

2. The traffic information available from the traffic model is the expected normal high growth and low growth 2-way 24 hour AADT flows on each road for the year 2014 (about 15 years after the expected opening date):-

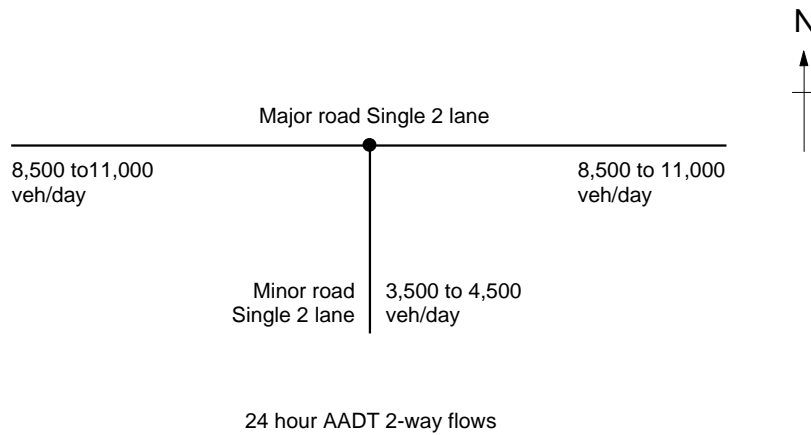

3. From the AADT 2-way flows, the AAHT 2-way flows on the approach roads in 2014 are calculated. AAHT = AADT/24, for example, $8500/24 = 354$; $11000/24 = 458$; etc.

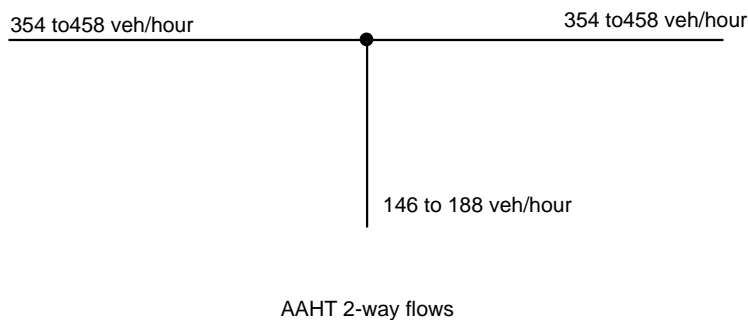

4. In view of the free flowing nature of the contiguous network, it has been decided in this particular case to use the estimate of the 50th highest hour in 2014 to obtain the 2-way flows on approach roads in the design peak hour. Thus AAHT is factored by 2.891 (see TAM). For example, $354 \times 2.891 = 1023$, say 1000; $458 \times 2.891 = 1324$, say 1300; etc.

5. To obtain the directional flows (ie, the range of the entry flows into the junction) from the design peak hour 2-way flows on the approach roads it has been decided in this case to assume a 60/40 split with the entry flows from the west and south dominant. For example, $1000 \times 0.6 = 600$; $1300 \times 0.6 = 780$, say 800; $1000 \times 0.4 = 400$; etc.

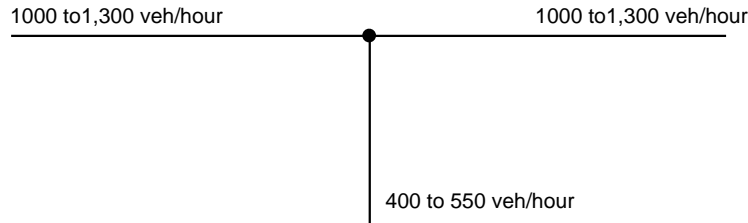

Design Peak Hour 2-way flows

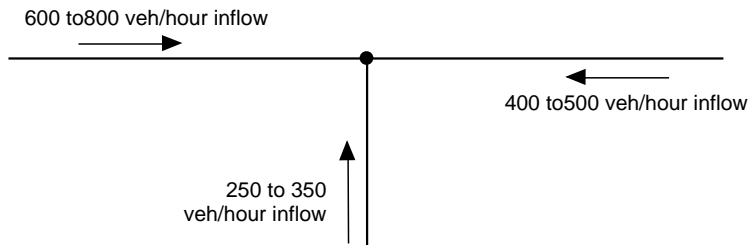

Directional flows

6. The dominant turning movements are not known, so the following three patterns will be assessed as they should reflect the range of possibilities in the design peak hour.

Directional flows when adjusted using turning proportions are termed "Design Reference Flows".

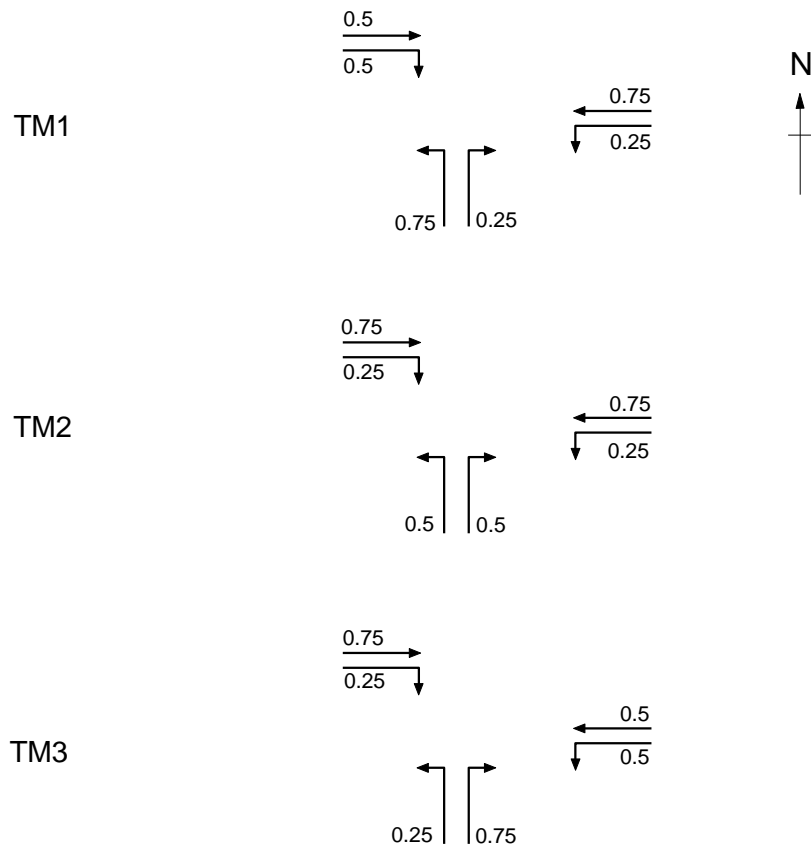

7. From the Reference Flows it appears that there are two feasible alternative layouts, a 3.5m wide ghost island and single lane dualling, both with two entry lanes on the minor road. The geometric parameters are as follows:-

8. The trial layouts are assessed for their peak hour performance over the range of Design Reference Flows using the PICADY/3 program. The results following indicate maximum RFCs, queue lengths and delays that can be expected. The maximum RFC is 89% on the right turn from the minor road for the 3.5m ghost island at high growth for TM 3.

3.5m Ghost Island

W	6.00m
W _{cr}	0.00m
w _{c-b}	3.50m
V _{r-c-b}	250.0m
V _r	225.0m, minor road
V _l	225.0m, minor road
w _{b-c}	4.25m
w _{b-a}	4.25m

Single Lane Dualling

W	8.00m
W _{cr}	10.00m
w _{c-b}	4.50m
V _{r-c-b}	250.0m
V _r	225.0m, minor road
V _l	225.0m, minor road
w _{b-c}	4.25m
w _{b-a}	4.25m

Traffic being appraised	Range of Reference flows (v.p.h.)	Checks on R.F.C.s, queue lengths and delays for trial designs		
		3.5m Ghost island 2 lane minor road entry	Single Lane Dualling 2 lane minor road entry	
LOW GROWTH	<p>600 → ← 400 250 ↑ TM 1</p>	<p>53%.1.12 ↓ ← 32%.0.8 20%.0.12 →</p>	<p>47%.1.9 ↓ ← 31%.0.8 13%.0.7 →</p>	
		<p>26%.0.8 ↓ ← 22%.0.7 35%.1.13 →</p>	<p>24%.0.7 ↓ ← 21%.0.7 24%.0.6 →</p>	
		<p>26%.0.8 ↓ ← 11%.0.6 50%.1.16 →</p>	<p>24%.0.7 ↓ ← 11%.0.6 35%.1.9 →</p>	
	HIGH GROWTH	<p>800 → ← 500 350 ↑ TM 1</p>	<p>74%.3.21 ↓ ← 50%.1.11 42%.1.24 →</p>	<p>67%.2.15 ↓ ← 46%.1.10 23%.0.10 →</p>
			<p>37%.1.9 ↓ ← 35%.1.10 65%.2.30 →</p>	<p>33%.0.8 ↓ ← 32%.0.9 40%.1.12 →</p>
			<p>37%.1.9 ↓ ← 18%.0.8 89%.5.61 →</p>	<p>33%.0.8 ↓ ← 15%.0.7 57%.1.15 →</p>
		<p>KEY:- 74%.3.21 means maximum R.F.C. 74%, maximum queue length 3 vehicles, maximum delay per vehicle 21 seconds.</p>		

Annex 1

9. The cost of traffic delays over the scheme life is evaluated for the two options at low and high growth using COBA 9. The turning movements are modified to achieve balanced link flows on a daily basis, but there are still three distinct cases of equal left and right turns from the minor road, a predominant left turn from the minor road (75/25 split), and a predominant right turn from the minor road (25/75 split). The 3.5m ghost island is estimated to cost £30,000 and single lane dualling £117,000, at 1993 prices. The COBA 9 results are as follows (all discounted costs in thousands of pounds):-

First Scheme Year	1999
Traffic Figures	2014

Equal minor road turning movements

	Construction Costs	Delay Costs	
		Low	High
3.5m Ghost Island	18	270	408
<u>Single Lane Dualling</u>	<u>- 72</u>	<u>- 258</u>	<u>- 384</u>
	<u>- 54</u>	<u>+ 12</u>	<u>+ 24</u>

Therefore Incremental NPV in going from a ghost island to single lane dualling is:-

Low Growth	- 42
High Growth	- 30

Predominant left turn from minor road

	Construction Costs	Delay Costs	
		Low	High
3.5m Ghost Island	18	270	363
<u>Single Lane Dualling</u>	<u>- 72</u>	<u>- 258</u>	<u>- 354</u>
	<u>- 54</u>	<u>+ 6</u>	<u>+ 3</u>

Therefore Incremental NPV in going from a ghost island to single lane dualling is:-

Low Growth	- 48
High Growth	- 45

Predominant right turn from minor road

	Construction Costs	Delay Costs	
		Low	High
3.5m Ghost Island	18	306	489
<u>Single Lane Dualling</u>	<u>- 72</u>	<u>- 285</u>	<u>- 432</u>
	<u>- 54</u>	<u>+ 21</u>	<u>+ 57</u>

Therefore Incremental NPV in going from a ghost island to single lane dualling is:-

Low Growth	- 33
High Growth	+ 3

10. Having examined the results it can be seen that the only case of the suggested maximum RFC ratio of 75% being exceeded is the right turn out of the major road for the ghost island at high growth when there is a predominant right turn from the minor road (89%, 5.61). However, since the major road is 100kph design speed, RFC values exceeding 75% should not be accepted (see paragraph 2.32). Additionally the differences in NPV between the ghost island option and the single lane dualling option are only small, therefore (other things being equal) the single lane dualling option should be chosen.

In cases where single lane dualling is being considered a check must be made on the character of the major road for at least 3km on either side of the proposed junction. If stretches of full dualling or local dualling occur (or are likely to occur) then it would be prudent to adopt the ghost island instead.

Minor Road Inclination (°)	Offset d (m)
70	1.5
80	2.0
90	2.5
100	2.0
110	1.5

Table A2/1: Channelising Island Offset

Width of Major Road Carriageway at Junction (m)	Radius R ₁ (m)
9.5	12
10.0	12
11.0	14
18.0 (single lane dualling)	22
24.6 (dual carriageway)	26

Note: Radius R₂ is normally the same value as R₁ but should be designed to ensure that the island nose is positioned between 2 - 4 metres from the edge of the main carriageway and that the width of the island lies between 2 - 5 metres.

Table A2/2: Design of Radius R₁

Crossroads

4. The recommended layout for rural crossroads where long vehicles are predicted, and where the minor road centreline is inclined to the major road at an angle between 70° and 110°, is shown in Figure A2/2.

5. There are similarities in the design to that outlined previously, but the following points should be noted:-

a. The long axis of the island is inclined at 5° to the minor road centreline and the island is always 3m wide.

b. The circular arc R₁ has a radius of 11m and is tangential to the left hand side of the island (viewed from the minor road approach) and the centreline of the major road. (In some cases where the minor road is inclined to the major road at angles between 100° and 110°, R₁ will have to be reduced to 8m to create a suitable island.)

c. The circular arc R₂ has a radius of 11m and is tangential to the major road centreline and the minor road centreline.

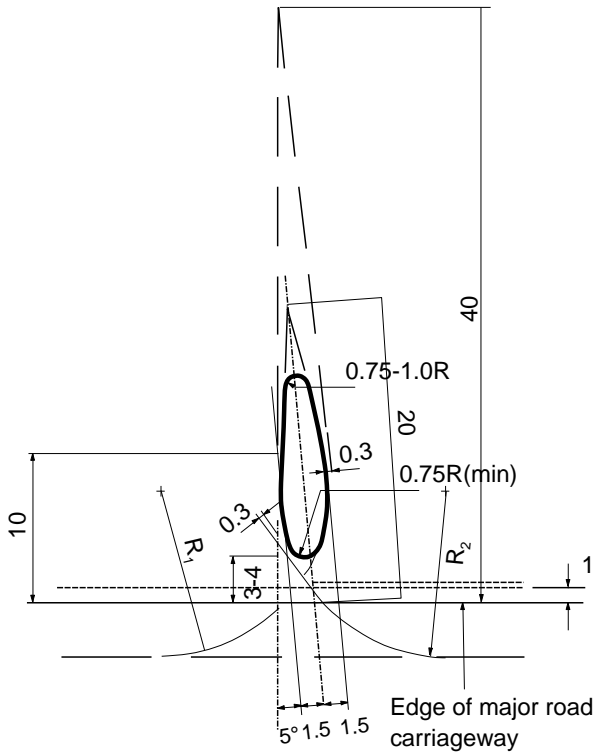

6. Where the minor road centreline is inclined to the major road at angles less than 70° , R_1 will normally be 12m and R_2 8m.
7. Where the minor road centreline is inclined to the major road at angles greater than 110° , R_1 will normally be 8m and R_2 12m.
8. Where two splay minor roads meet at a crossroads, the minor road centrelines should be offset relative to one another by approximately the width of one island.

**Figure A2/2 : Design of Rural Crossroads
 Channelling Island (Dimensions in metres)**