

---

**VOLUME 2 HIGHWAY STRUCTURES:  
DESIGN  
(SUBSTRUCTURES AND  
SPECIAL STRUCTURES)  
MATERIALS**

**SECTION 2 SPECIAL STRUCTURES**

---

**PART 8**

**TD 19/06**

**REQUIREMENT FOR ROAD  
RESTRAINT SYSTEMS**

**SUMMARY**

This Standard describes the procedures to be followed by the various parties involved in the design and provision of various types of Road Restraint Systems. It also introduces a risk based framework to support designers in making optimal design choices at specific sites.

**INSTRUCTIONS FOR USE**

1. Remove Contents pages from Volume 2 and insert new Contents pages for Volume 2 dated August 2006.
2. Remove the following documents from Volume 2 which are superseded by this Standard and archive as appropriate:  
  
BA 48/93, Volume 2, Section 2  
BD 52/93, Volume 2, Section 3  
TA 45/85, Volume 2, Section 2  
TD 19/85, Volume 2, Section 2  
TD 32/93, Volume 2, Section 2
3. Insert TD 19/06 into Volume 2, Section 2, Part 8.
4. Please archive this sheet as appropriate.

Note: A quarterly index with a full set of Volume Contents Pages is available separately from The Stationery Office Ltd.



**THE HIGHWAYS AGENCY**



**TRANSPORT  
SCOTLAND**

**TRANSPORT SCOTLAND**



**Llywodraeth Cynulliad Cymru  
Welsh Assembly Government**

**WELSH ASSEMBLY GOVERNMENT  
LLYWODRAETH CYNULLIAD CYMRU**



**DRD**

Department for  
Regional Development  
www.drni.gov.uk

**THE DEPARTMENT FOR REGIONAL DEVELOPMENT  
NORTHERN IRELAND**

# Requirement for Road Restraint Systems

**Summary:** This Standard describes the procedures to be followed by the various parties involved in the design and provision of various types of Road Restraint Systems. It also introduces a risk based framework to support designers in making optimal design choices at specific sites.

REGISTRATION OF AMENDMENTS

Amend No	Page No	Signature & Date of incorporation of amendments	Amend No	Page No	Signature & Date of incorporation of amendments

SUPERSEDED

REGISTRATION OF AMENDMENTS

Amend No	Page No	Signature & Date of incorporation of amendments	Amend No	Page No	Signature & Date of incorporation of amendments

SUPERSEDED

---

**VOLUME 2 HIGHWAY STRUCTURES:  
DESIGN  
(SUBSTRUCTURES AND  
SPECIAL STRUCTURES)  
MATERIALS**

**SECTION 2 SPECIAL STRUCTURES**

---

**PART 8**

**TD 19/06**

**REQUIREMENT FOR ROAD  
RESTRAINT SYSTEMS**

**Contents**

Chapter

1. Introduction
  2. Overview of Risk and Mitigation and Considerations for Selection
  3. Criteria and Guidance for the Provision of Permanent Safety Barriers
  4. Criteria for the Provision of Vehicle Parapets
  5. Criteria and Guidance for the Provision of Terminals
  6. Criteria and Guidance for the Provision of Transitions
  7. Criteria and Guidance for the Provision of Crash Cushions
  8. Criteria and Guidance for the Provision of Temporary Safety Barriers at Road Works
  9. Pedestrian Restraint Systems
  10. Vehicle Arrester Beds
  11. Anti-glare Screens
  12. References
  13. Enquiries
- Appendix 1 Lists A and B
- Appendix 2 Guidance on the Specification of Vehicle Restraint Systems for Low Speed and/or Low Traffic Flow Roads

**List of Figures**

**Chapter 1**

- 1-1 Dynamic Deflection (D) and Working Width (W)
- 1-2 Road Restraint Systems Terminology and Definitions

**Chapter 2**

- 2-1 Risk - Regions of Acceptability
- 2-2 Some factors that may affect the choice of Restraint System

**Chapter 3**

- 3-1 Minimum Distances of Safety Barrier from the Top and Toe of Slopes at Verges where Safety Barrier is Required for Other Reasons
- 3-2 Minimum Distances of Safety Barrier from the Top and Toe of Slopes in Central Reserves where Safety Barrier is Required for Other Reasons
- 3-3 Central Reserve: Ranges of Positions for Double Sided Safety Barrier
- 3-4 Set-back and Working Widths Adjacent to Hazards
- 3-5 Verge Safety Barrier Layout Adjacent to Hazards
- 3-6 Central Reserve Safety Barrier (Single Sided) Layout Adjacent to Hazards
- 3-7 Central Reserve Safety Barrier (Double Sided) Layout Adjacent to Hazards
- 3-8 Provision of Safety Barriers at Structural Support in Verges
- 3-9 Requirements for Protection of Sign/Signal Gantries from Collision Loads
- 3-10 Provision of Rigid Safety Barriers at Restricted Headroom
- 3-11 Accommodating Emergency Telephone at Verge Safety Barrier
- 3-12 Taper Lengths at Changes in Horizontal Alignment of Verge and Central Reserve Safety Barrier
- 3-13 Safety Barrier Layouts and Factors to Consider at Nosings
- 3-14 Central Reserve Pedestrian Crossing Point
- 3-15 Safety Barrier at "Open" Emergency Crossing Points
- 3-16 Central Reserve Maintenance Crossover at Tunnels
- 3-17 Example of Winter Maintenance Crossing

**Chapter 6**

- 6-1 Example of Pocketing

**Chapter 8**

- 8-1 Temporary Safety Barrier Provision adjacent to Temporary Bridge Supports

**Chapter 9**

- 9-1 Safety Barrier Protection to Pedestrian Guardrail
- 9-2 Typical Locations for Pedestrian Protection - Wingwalls
- 9-3 Typical Locations for Pedestrian Protection - Retaining Walls
- 9-4 Typical Locations for Pedestrian Protection - Culverts

**Chapter 10**

- 10-1 Arrestor Bed Remote from Carriageway
- 10-2 Arrestor Bed Adjacent to Carriageway

# 1. INTRODUCTION

## Background

1.1 Following the Selby Rail Crash, the Deputy Prime Minister set up the Highways Agency Working Group to Review the Standards for the Provision of Nearside Safety Fences on Major Roads.

1.2 The Group concluded that there were no major shortcomings in the safety barrier standard (TD 19/85) and its application to the nearside of major roads. However, a number of concerns were noted:

- It is not clear what lay behind the standards.
- What risks the procedures/standards were trying to consider.
- What risks the procedures/standards were trying to control.
- The Standard was primarily written for new works; there was a need to manage risks for other types of work (e.g. planned maintenance).
- How risks were assessed when granting Departures from Standard.
- How consistency in the Overseeing Organisation's advice on safety risks is ensured.

1.3 As an interim measure, until a risk-based standard could be produced, the Interim Requirement for Road Restraint Systems (IRRRS) document was published in July 2002 which brought together and revised the requirements in all Vehicle Restraint Systems (VRS) and related standards into one document.

1.4 This risk theory-based Road Restraint Standard addresses these concerns and has been developed to:

- introduce risk analysis into the design and assessment process;
- make the risk assessments that are implicit within standards more transparent;
- provide computer software to enable a risk assessment process to be carried out following recommended design practices to ensure consistency in design appraisal;
- enable designers to carry out site-specific risk assessments within the design process in order to select appropriate design parameters for all types of works;
- provide a framework to support designers in making optimal design choices at specific sites.

## Use of the Standard

1.5 This Standard has been prepared for use by appropriately qualified and experienced professional staff (as required by HD 46 Quality Management Systems for Designers [DMRB 5.2.1]). It is not a statutory or regulatory document, nor a training manual; neither does it cover every point in exhaustive detail. Many matters are left to the professional expertise and judgement of users, while others are covered elsewhere, in British, European or International Standards (ISO), in Codes of Practice and in Specifications which are cross-referenced in the text. The mandatory requirements given in the Standard must be adhered to for all Trunk Roads (and in Northern Ireland those roads designated by the Overseeing Organisation) with a mandatory speed limit of 50 mph or more (but also see Paragraph 1.23), unless a Departure from Standard is approved (see Paragraphs 1.37 to 1.40 [Relaxations and Departures] below).

1.6 This risk based Road Restraint System (RRS) Standard does not follow the conventional Standard format. The Standard has two Parts that must be used together, namely: the written Standard **TD 19 Requirement for RRS [DMRB 2.2.8]** and the Road Restraint Risk Assessment Process (RRRAP), which is software driven. This software is available from; [www.highways.gov.uk](http://www.highways.gov.uk) and is located in: “Doing Business With Us/Technical Information”.

1.7 The written document evolved from the IRRRS that introduced performance-based criteria instead of product specific information.

1.8 The written Standard describes the procedures to be followed by the various parties involved in the design, and provision of various types of RRS (See Terminology and Definitions in Paragraphs 1.41 and 1.42) on the road network to ensure compliance with European Commission requirements for RRS set out in European Standard BS EN 1317-1 to -3 and DD ENV 1317-4:2002, and in prEN 1317-5 and prEN 1317-6 which are currently available as drafts.

1.9 The Standard details the requirements and criteria and gives guidance for the provision, design and layout of permanent and temporary safety barriers, vehicle parapets, terminals, transitions/connections, crash cushions, pedestrian parapets, pedestrian guardrails, vehicle arrester beds and anti-glare screens.

1.10 The design process, of which the RRRAP is an integral part, enables the Designer to determine at each specific site, the need for a VRS (See Terminology and Definitions in Paragraphs 1.41 and 1.42) and its performance requirements.

1.11 The RRRAP software has two main elements: risk analysis, and risk assessment. Risk analysis enables the designer to enter information about a particular site (such as: location and hazard; traffic speed; alignment), and the risk that each hazard may pose, to be presented in terms of the probability of an accident/year/km and benefit/cost ratio. The software then enables various control measures to be reviewed and their effect on the risk level and relative benefit/cost assessed. For example, redesign or relocation of the hazard; protection with a VRS; no protection. Further guidance and information is given in Chapter 2.

1.12 Introduction of a VRS does not make a situation totally safe. Every year, there are injuries caused when vehicles hit VRS and, in some circumstances, it may be better to move or not to protect a hazard. The RRRAP acknowledges that VRS have an inherent element of risk and that this risk has to be balanced by the cost benefit afforded by a VRS in mitigating the severity and implications of accidents.

## Scope

1.13 This composite Standard on RRS replaces and supersedes the Departmental Standards, Advice Notes and Interim Advice Notes (IANs) detailed in Appendix 1 – List A of this Standard and these documents are herewith withdrawn. The Standard also partially amends several other Departmental Standards and Advice Notes and details of the relevant amendments are given in Appendix 1 – List B. When this Standard refers to a Highways Agency’s IAN, the user is advised to ensure that the latest version of the IAN or Standard that replaces the IAN is used, and to confirm the status of the guidance/policy in the IAN with the other Overseeing Organisations.

## Mandatory Sections

1.14 Mandatory Sections of this document are contained in boxes. The Design Organisation and Contractor must comply with mandatory sections; if it is not possible to comply, they must agree a suitable Departure from Standard with the relevant Overseeing Organisation. The remainder of the document contains advice, explanation and guidance, which is commended to Design Organisations and Contractors for their consideration. (See Paragraph 1.5).

### Durability and Evaluation of Conformity

1.15 All RRS that are covered by BS EN 1317-1, -2, -3 and DD ENV 1317-4 or its successor European Standard (EN) and draft\* CEN Standard prEN 1317-6, which are to be installed on public highway, must satisfy the requirements of draft\* CEN Standard prEN 1317-5: Product Requirements and Evaluation of Conformity for Vehicle Restraint Systems.

\* Note: Draft CEN or its final published version, whichever is current at the time.

### Quality Assurance

1.16 Until publication of prEN 1317-5, the Overseeing Organisation will continue to implement the Quality Assurance (QA) Sector Schemes for VRS listed in Appendix A of the Manual of Contract Documents for Highway Works [MCHW-1].

1.17 All VRS installed for use on the Trunk Road network, and on all roads in Northern Ireland, must be installed and maintained by qualified personnel in accordance with Sector Schemes 2B and 5B (See Appendix A of MCHW-1), where these Schemes are applicable. VRS, such as concrete safety barrier, that are not covered by these Sector Schemes must be installed and maintained by suitably trained and experienced personnel.

### Implementation

1.18 This standard must be applied as follows on all Trunk Roads with speeds of 50 mph or more in England, Scotland and Wales, and in Northern Ireland on those roads designated by the Overseeing Organisation with speeds of 50 mph or more:

- (i) this Standard MUST be used:
  - (a) on all New roads;
  - (b) on schemes where the highway cross-section is being altered permanently:  
*Comment: this will include road widening schemes and improvements, e.g. where road capacity is increased, lane widths are reduced, traffic will run closer to a hazard or hazards than in existing situation;*
  - (c) whenever the RRS is life (serviceable life) expired and needs replacing;
  - (d) whenever a new hazard is introduced and a RRS may be required. A new hazard may be, for instance, new road furniture or a change in the ground profile or where existing road furniture is relocated;
  - (e) whenever a VRS needs to be dismantled (other than where localised sections need to be removed to gain access), e.g. during planned maintenance schemes:  
*Comment: The existing VRS may be reused if it is BS EN 1317 compliant and meets the specified Performance Class Requirements and can be reinstalled to meet the Working Width requirements. The existing VRS may be named in the contract document. On post and rail safety barrier, it is normal for posts to be renewed rather than reused.*
- (ii) consideration MUST be given to upgrading existing RRS or installing a new RRS where an existing one does not exist, when:

other works (excluding routine maintenance) are being carried out near a hazard that is currently without provision for which the RRRAP indicates provision is required, or near an existing RRS that does not meet the requirements of this Standard (e.g. on Containment Level, Working Width, or VRS is not BS EN 1317 compliant). The remaining life within the existing RRS must be examined and if it is less than five years and no other major maintenance works are planned during the remaining life of the existing System, and where installation of the new RRS would not significantly increase any traffic management required for the other works, then upgrading should strongly be considered;

(iii) exception:

- (a) when minor repair work is required or when the RRS is required to be replaced due to accident damage, like for like renewal is allowed. However, as above, if the RRS can be brought up to Standard, the opportunity must be taken;
- (b) if a length of less than 500 m in a section of VRS between terminals needs to be dismantled or replaced as part of planned maintenance and the remaining length is greater than 500 m and would remain unaltered, then like for like replacement is allowed. However, if the remaining length is less than 500 m, then the entire length must be installed in accordance with Paragraph 1.18(i). Paragraph 1.48 of the Guidance Section must be reviewed before this exception is applied;
- (c) schemes already under construction and those currently being prepared where this would result in significant additional cost or delay (consideration must be given to bringing those RRS up to current standards in future Maintenance programmes).

1.19 If the suitability or adequacy of any existing RRS is in doubt, Design Organisations must seek guidance from the Overseeing Organisation, on a scheme specific basis.

1.20 Further guidance on Paragraphs 1.18 (i), (ii) and (iii) is given in Paragraphs 1.45 to 1.48 of the Guidance section below.

1.21 This Standard for RRS is developed and produced for use on the Trunk Road network, (see Paragraph 1.5). These roads form a strategic road network of typically dual or high standard single carriageways, carrying high volume and/or high-speed traffic (i.e. with speed limits of 50 mph or more).

1.22 RRS must also be provided on the Trunk Road network where the Design Speed or Imposed Speed Limit is less than 50mph and the Design Organisation considers such provision is needed and the Overseeing Organisation has agreed that a RRS must be provided.

1.23 The RRRAP has not been developed to assess the risk from roadside hazards at speeds of less than 50 mph and/or for traffic flows of less than 5,000 AADT. If the risk from roadside hazards, therefore, needs to be assessed at speeds of less than 50 mph or traffic flow of less than 5,000 AADT, then the following may be considered:

- (i) Use the RRRAP at 50mph and the higher of the AADT for the road and 5,000 AADT, but use all other information from the site to aid any decision making about those road side hazards. It is recommended that a site inspection is carried out to ensure local hazards are considered that might fall outside the hazards included within the RRRAP.
- (ii) Carry out a separate risk assessment without the aid of the RRRAP and use the guidance and technical requirements to aid in the decision making process. An example of such a risk assessment process is given in Appendix 2.

## The Road Restraint Risk Assessment Process

1.24 A fundamental element of the design procedure is the requirement to record formally all the factors considered in the design process that were used to determine the need or otherwise for a RRS at a particular location or locations. This will include the nature and parameters, position and extent of the RRS and hazards present or known about at the time and justification for the decisions made in the design.

1.25 The RRRAP that forms an integral part of this Standard is the vehicle through which this procedure is undertaken and the decisions recorded.

1.26 Design Organisations must consider the requirements for Road Restraint provision at an early stage in the scheme's development (i.e. before the land footprint or land take is decided) and design processes to:

- (i) ensure that all factors that are under the Designer Organisation's/Overseeing Organisation's control including land take, road and cross-section geometry, and location of hazards are considered in determining the overall optimum solution (see Paragraph 1.27 below);
- (ii) minimise the need for Departures from Standard;
- (iii) eliminate or mitigate, as far as reasonably practicable, factors that might be detrimental to the safety of those who use and work on the road, and of Others that might be affected by use of the road.

1.27 Such factors may vary from scheme to scheme and location to location, but typically include: carriageway and junction alignment; lane and hardshoulder or hardstrip width; verge and slope cross-section and type of surface; type of drainage; the location (eg. offset), nature, arrangement and form of the hazards themselves; and maintenance of all aspects. For instance, consideration should be given to preventing grass growth in front of vehicle restraint systems, for example, by sealing a portion of verges, so that grass cutting operations do not require workers to be positioned in front of safety barriers. For further guidance, please see **Interim Advice Note 69** for HA purposes or refer to the respective Overseeing Organisation for advice. Where there are difficulties, for example with carriageway and junction alignment and in achieving cross-section requirements, the Overseeing Organisation may be consulted.

1.28 The basis of the RRRAP, together with the typical information that is required and must be recorded is further explained in "Guidance on use of the Road Restraint Risk Assessment Process" which, along with the RRRAP software, is available from; [www.highways.gov.uk](http://www.highways.gov.uk) and is located in: "Doing Business With Us/Technical Information". Further guidance and information is given in Chapter 2.

### Information to be Provided and or Specified

1.29 The results of the RRRAP for each design must be included as part of the Health and Safety documentation required under the CDM Regulations. For tendered schemes including private developer schemes (under Section 278 of the Highways Act 1980 or, in Northern Ireland, under Article 122 of The Roads (NI) Order 1993), this will be prior to invitation to tender; for Early Contractor Involvement (ECI) schemes and Design and Build (D&B) or Design Build Finance Operate (DBFO) schemes, prior to commencement of construction; and for term maintenance and framework contracts, prior to issue of the works order or task order to the Contractor.

1.30 The Design Organisation may propose any solution that may include or exclude the need for a RRS, as long as it complies with this Standard, and the level of risk from the RRRAP is shown to be 'broadly acceptable'. For any solution that requires a RRS, the Design Organisation must specify the level of performance and Length of Need of a RRS for a particular location as follows:

For safety barriers, vehicle parapets and transitions:

- Containment Level;
- Impact Severity Level (ISL);
- Working Width Class;
- The maximum height that allows the required visibility;
- Length of Need for safety barrier and parapets.

For crash cushions:

- Performance Level – this must indicate whether a redirective or non-redirective crash cushion is required;
- ISL;
- Redirection Zone Class (Z);
- Permanent Lateral Displacement Zone Class (D);
- The maximum height that allows the required visibility.

For end terminals for a particular location:

- Performance Class (P);
- ISL;
- Permanent Lateral Displacement Zone (PLDZ) characteristic;
- Exit Box Class;
- The maximum height that allows the required visibility.

Brief definitions are given at the end of this Chapter; detailed definitions of these performance criteria can be found in BS EN 1317-1, -2, -3, DD ENV 1317-4:2002 and draft Standards prEN 1317-5 and prEN 1317-6.

1.31 The Design Organisation must identify other factors, such as those outlined in Chapter 2 relating to ‘product lifecycle’ and in Chapter 3 Paragraphs 3.109 and 3.110, that may affect the choice of System to prevent the use of unsuitable systems. The Contractor must confirm that each RRS proposed and installed meets the ‘Length of Need’ and other criteria stipulated by the Design Organisation at every location.

1.32 Details of the RRS installed by the Contractor, including details of any changes made during the construction phase, together with justification, must be recorded via the RRRAP and submitted to the Overseeing Organisation as part of the Health and Safety File information.

1.33 RRS manufacturers must provide certification from an accredited Notified Certification Body that their RRS complies with the requirements of BS EN 1317. The Contractor will be permitted to provide any RRS that complies with BS EN 1317 and which meets the design requirements. (See also Paragraph 1.50).

1.34 At present, ratification of Notified Certification bodies has not been completed; until such bodies are accredited, refer to CI 401 in MCHW - 1 Series 400 Road Restraint Systems (Vehicle and Pedestrian) for information on acceptable products.

1.35 For any site where it is not possible to propose a solution that produces an ‘acceptable’ level of risk, the Design Organisation must consider if a Relaxation can be used. If a Relaxation cannot be used, a Departure from Standard must be applied for as outlined in Paragraphs 1.39 and 1.40.

### Road Safety Audits

1.36 Road Safety Audits must be undertaken on all highway schemes involving removal, provision or improvement of RRS in accordance with **HD 19 [DMRB 5.2.2]**.

### Relaxations

1.37 Where permitted in this document, Relaxations may be introduced at the discretion of the Design Organisation, having regard to the advice and guidance in this document and all relevant local factors. (Note: in Northern Ireland, Relaxations are not at the discretion of users, but can only be granted by the Overseeing Organisation).

1.38 Careful consideration must be given to layout options and the effects of incorporating Relaxations, having weighed the benefits and any potential disbenefits. Particular attention must be given to the environmental and safety aspects (including construction, maintenance, operation and demolition) that would result from the use of Relaxations. The preferred option must be compared against options that would meet full Standards. The Design Organisation must record in the RRRAP the fact that a Relaxation has been used in the design and the corresponding reasons and justification for its use. It is recommended that the details of the Relaxation and justification are copied to the relevant Overseeing Organisation prior to incorporation into the Works.

### Departures from Standard

1.39 Where special circumstances arise and the straightforward application of the technical requirements cannot be achieved or justified for some reason, such as the environmental impact, exceptional layout situations or cost, users are encouraged to come forward with Departures which go beyond Relaxations from the criteria, or to propose additional criteria (for aspects not covered by existing documents) based on a reasoned assessment. Each Overseeing Organisation has procedures for considering and accepting or rejecting such proposals on their merits.

1.40 Full justification for the grounds of the proposed Departure must be forwarded to the relevant Overseeing Organisation at an early stage in design. The risk level (where known) and cost benefit analysis from the RRRAP for the proposed solution must form part of the Departure. The Departure must demonstrate that the risk level of the proposed solution is As Low as Reasonably Practicable (ALARP); further guidance is given in Chapter 2. Formal approval to the proposed Departure must be received BEFORE incorporation into the design and the commencement of construction. Departures from Standard are determined on an individual basis and a decision regarding a Departure for one location must not be assumed as the decision for any other, even similar, situations. Approval for a Departure from Standard after commencement of construction will only be given in exceptional circumstances; no Departure will be granted after completion of the works.

### Terminology and Definitions

1.41 Many of the definitions set out below are not industry standard definitions and apply only in the context of this Standard.

1.42 Figure 1-2 shows the terminology and definitions for RRS included in the various Parts of BS EN 1317 and DD ENV 1317-4. For the definitions of other terms used in Paragraph 1.30, refer to the relevant parts of BS EN 1317. Additional definitions are included below.

**Overseeing Organisation** – The Highway or Roads Authority responsible for the road in England, Scotland, Wales or Northern Ireland.

**Design Organisation/Designer** – Any person who carries on a trade, business or other undertaking in connection with which he prepares a design or arranges for any person under his control (including, where he is an employer, any employee of his) to prepare a design.

**Contractor** – The Organisation undertaking the various phases of a scheme which might include design, construction and/or maintenance.

**Adjoining Paved Surface** – The paved area on the traffic side of a parapet immediately adjacent to the plinth or base of the parapet. This surface may be the raised verge and central reserve at underbridges described in TD 27.

**Front Face of Parapet** – The face nearest to vehicular traffic.

**Hazard** – Refer to Chapter 2 Paragraphs 2.1 and 2.2 of this Standard. Examples are given as ‘drop downs’ in the various worksheets in the RRRAP.

**Length of Need** – The total minimum length of full height, full containment VRS stipulated by the Designer, as a result of the RRRAP, as being required in advance of, alongside, and after a hazard or hazards to protect the hazard or hazards. The length over which various VRS reach full containment may vary and will need to be checked with the manufacturer. The overall length of safety barrier required will be the Length of Need plus the additional lengths that are declared by the manufacturer to be required before and after the Length of Need to ensure that the safety barrier attains full containment. For example: if the Length of Need is 38 m (30 m + 0.5 m + 7.5 m), but full containment cannot be achieved within the safety barrier in less than 20 m, then for a dual carriageway 58 m (i.e. 20 m + 38 m) and for a single carriageway 78 m (i.e. 20 m + 38 m + 20 m) of full height safety barrier must be used. Refer to Chapter 3 Figure 3-5.

**Main Structure** – Any part of the bridge, viaduct, retaining wall or similar structure upon which a pedestrian or vehicle parapet is mounted, including the plinth.

**Medium Vehicle** – A vehicle greater than 1.5 Tonnes and less than or equal to 3.5 Tonnes.

**Others** – A group or collection of people in a public place, such as a school, hospital or railway, that might be injured in numbers by an errant vehicle or by a hazard that is hit by an errant vehicle, or a high value asset or facility that might be adversely affected by such an event.

**Outer Face of Parapet** – The face remote from the vehicular traffic.

**Planned Maintenance** – Planned work that is required due to those parts of the highway that have become unserviceable because of general wear or tear or due to a major upgrade or change to parts of the highway. (This excludes work associated with accident damage which is covered by routine maintenance).

**Plinth** – A continuous upstand on the edge of a structure upon which a vehicle or pedestrian parapet is mounted.

**Practicable** – Capable of being put into practice with the available resource at a reasonable price and within a reasonable period of time.

**Risk** – Refer to Chapter 2 Paragraphs 2.1 and 2.2 of this Standard.

**Road Restraint System (RRS)** – General name for VRS and Pedestrian Restraint System use on the road.

**Routine Maintenance** – Generally short term or cyclic work that is necessary to keep the highway in good working order, such as safety barrier repair due to accident damage. It does not deal with the replacement or renewal of those parts of the highway which, over a longer term, become unserviceable because of general wear and tear which would properly be dealt with by planned programmes of structural maintenance work.

**Running Lane** – That part of the trafficked carriageway nearest to the verge or central reserve that is under consideration. Under normal running conditions, the hardshoulder of a motorway would not be trafficked and would therefore not be classed as the running lane. It may however become a temporary running lane under ‘Active Traffic Management’ (ATM) or become a temporary running lane under a temporary traffic management regime, perhaps for instance with a reduced speed limit. The speed used in the RRRAP, when assessing whether the Length of Need and Containment Level are sufficient for the ATM and/or temporary situation, should be the controlled limit or temporary mandatory limit that will be in force.

**Secondary Event** – An incident that arises as a result of an initial incident. For instance, a lighting column is struck in the initial incident and falls onto another hazard, such as a carriageway or a railway, thus causing a secondary event or creating a hazard to that hazard.

**Set-back** – Is the distance defined in Chapter 3 Figure 3-4 which shows the typical relationship between the Set-back and available Working Width for a safety barrier in the verge or central reserve (See also Figures 3-1 to 3-3 inclusive and Figures 3-5 to 3-10 inclusive). Refer to **TD 27** for further details.

**Sidelong Ground** – Is ground that falls away from the carriageway, where the road is not on a formed embankment. It typically occurs where the road is cut into the side of a hill such that the road is effectively in cutting on one side and is similar to an embankment situation where the ground drops away from the carriageway on the other.

**Vehicle Restraint System (VRS)** – System installed on a road to provide a level of containment for an errant vehicle.

**Working Width (W)** – Is defined in BS EN 1317-2. Refer to the Guidance in this Section below for further information on application of Working Width in this Standard and Figure 1-1.

**Working Width Class** – Is the designation W1, W2, W3, etc for Classes of Working Width Levels as given in BS EN 1317-2.

1.43 For the definitions of the general highway terms used in this Standard such as “Highway Types” (e.g. Trunk Roads, motorway and all-purpose roads) and “components of the highway” (e.g. embankment and cutting), see BS 6100: Sub Section 2.4.1 and, for terms such as cross-section, central reserve, verge, see **TD 27**.

## Abbreviations

1.44 A list of the abbreviations that have been used in the Standard and their meanings is given below.

AADT	Annual Average Daily Traffic (Two Way)
ALARP	As Low as Reasonably Practicable
ATM	Active Traffic Management
B/C	Benefit/Cost
BD	Overseeing Organisation Standards – Bridges and Structures
BS	British Standard
CBA	Cost Benefit Analysis
CCTV	Closed Circuit Television
CDM	Construction (Design and Management) Regulations
CEN	European Committee for Standardization or Comité Européen de Normalisation is the standards organisation responsible for producing and overseeing the development of standards. It is an association of the national standards bodies
D	Permanent Lateral Displacement (for crash cushions)
D&B	Design and Build

DBFO	Design, Build, Finance and Operate
DD	Draft for Development
DMRB	Design Manual for Roads and Bridges
ECI	Early Contractor Involvement
ECP	Emergency Crossing Point
EN	European norm or technical specification drafted by a technical committee and adopted as a national standard by members belonging to CEN
Et seq	And following
HA	Highways Agency
HD	Overseeing Organisation – Standard
IAN	Interim Advice Note
IRRRS	Interim Requirement for Road Restraint Systems
ISL	Impact Severity Level
LGV	Large Goods Vehicle (i.e. a vehicle over 3.5 Tonnes)
MCHW	Manual of Contract Documents for Highway Works
MCP	Maintenance Crossing Point
NI	Northern Ireland
NMU	Non-motorised User
OO	Overseeing Organisation
P	Performance Class (for terminals)
PLDZ	Permanent Lateral Displacement Zone characteristic (for terminals)
prEN	A draft European standard that is still in the process of being developed in preparation for publication as an EN
Psb	Point from which set-back is measured (refer to <b>TD 27 [DMRB 6.1.2]</b> )
QA	Quality Assurance
RRRAP	Road Restraint Risk Assessment Process
RRS	Road Restraint System
SI	Statutory Instrument
TD	Overseeing Organisation Standard relating to Traffic Engineering and Control
TRL	Transport Research Laboratory
TSM	Traffic Signs Manual
TSRGD	Traffic Signs Regulations General Directions (this is a Statutory Instrument)
WMCP	Winter Maintenance Crossing Point
VRS	Vehicle Restraint System
Z	Redirection Zone Class (for crash cushions)

## Guidance

### Implementation

1.45 It is important that a long term maintenance strategy is developed to ensure that RRS are upgraded in a timely and cost effective manner. With the introduction of the various parts of BS EN 1317, more systems are available and there could be more variation and types of systems used on the Trunk Road network. The maintenance regime and life expectancy for each RRS will vary, which will make routine maintenance and replacement more difficult to schedule and means stock for each type of RRS will need to be held in order to carry out any accident repairs promptly. It is, therefore, advisable to consider the selection of the RRS to be used, not just to meet the design requirements, but also to meet future repair and maintenance needs. It is also advisable that, for each new installation, the information about that RRS is recorded electronically. Information may include: date of installation, life expectancy, maintenance cycle, date of last repair, etc.

1.46 Consideration should be given to determining whether overall Roadspace occupation can be minimised by upgrading the RRS at the same time as other adjacent maintenance or improvement work is being carried out.

1.47 Usually when a RRS is damaged, it has to be repaired or made safe expeditiously, to minimise the risk posed by the damaged barrier or loss of containment. This does not normally give time for designs to be checked and new barriers to be procured and installed. Consideration could be given to providing temporary protection to give time, but space and other considerations may make this impracticable.

1.48 What is 'minor' repair work or a reasonable length for like for like replacement? (Paragraphs 1.18iii)(a) and (b) refer).

Like for like replacement must only be used when:

- the risks along an entire length of VRS are known and equal;
- replacement of old for new would have little or no effect on this risk;
- it offers the most practicable solution.

Some examples are given below:

Example 1:

- There is a 4 km length of safety barrier, the risk is consistent along the entire length, e.g. lighting columns equally offset behind safety barrier of consistent Working Width.
- The safety barrier does not conform to BS EN 1317-2 or to the current Working Width requirements.
- Up to 500 m of safety barrier is damaged or needs minor repair work.
- Replacing the 500 m section with a new section of safety barrier to the current Working Width/to conform to BS EN 1317-2 would reduce the risk over this 500 m only.
- It would have no effect over the remaining 3.5 km.
- The average risk over the 4 km would remain about the same.
- A new safety barrier would require a transition between the old safety barrier and new safety barrier or require modification to the highway geometry to accommodate a new Working Width Level.
- Like for Like replacement of this 500 m section is, therefore, the most practicable solution.

Example 2: However, in the above example above, were the overall length of barrier only 900 m, the full length would need to be replaced, and Paragraph 1.18(i) of this Standard should be followed because:

- Replacement of old safety barrier for new would have a significant effect on the risk, as the majority of safety barrier would be replaced.

Example 3: Where this exception would not apply is:

- A number of bridge piers are along a route and they are protected with a continuous length of safety barrier of approx 4 km.
- The Working Width complies with Standard except at the sections adjacent to the piers, which are substandard.
- Work is being done to strengthen the bridge piers and approx 400 m of safety barrier has to be removed alongside and in advance of and beyond each pier.
- The risk levels at these sections of safety barrier near the bridge are not the same as along the other sections of safety barrier, i.e. the risk is not equal along the entire length.
- Replacement of the safety barrier at the piers with new safety barriers to the correct Working Width will improve the safety barrier performance at these sections and lower the overall risk.
- Like for like replacement is, therefore, not acceptable.

## Working Width

1.49 Working Width (W) in this Standard is based on the BS EN 1317-2:1998 definition. This definition assumes:

$W = \text{width of the restraint system} + \text{its maximum dynamic lateral deflection} + \text{vehicle intrusion beyond the restraint system (also known as overhang)}$ .

1.50 The BS EN 1317 definition of W is due to be changed in future versions of BS EN1317-2. Please check with the System's manufacturer as to what version of BS EN 1317 was used to define W for their System, as this can affect the System's suitability at a particular location and the associated risk.

1.51 When a High or Very High Containment or rigid VRS is hit by an Large Goods Vehicle (LGV) or other tall vehicle, there is a tendency for the vehicle to roll and intrude into the area behind the Vehicle Restraint System. This normally occurs to a lesser degree with Normal Containment deformable safety barriers which deflect more.

1.52 Where the Working Width 'W' for a system is based on the BS EN 1317:1998 definition, this will allow for vehicle intrusion. Where 'W' for a system is based on the proposed revised BS EN 1317-2, a check should be carried out to ensure that there is sufficient clearance between the hazard being protected and the VRS that is proposed, to ensure that the protected hazard will not be hit by a vehicle intruding over the restraint system. (Refer also to Chapter 3 Paragraph 3.10).

Figure 1-1 below is based on an extract from BS EN 1317-2:1998 showing how Working Width and overhang are measured.

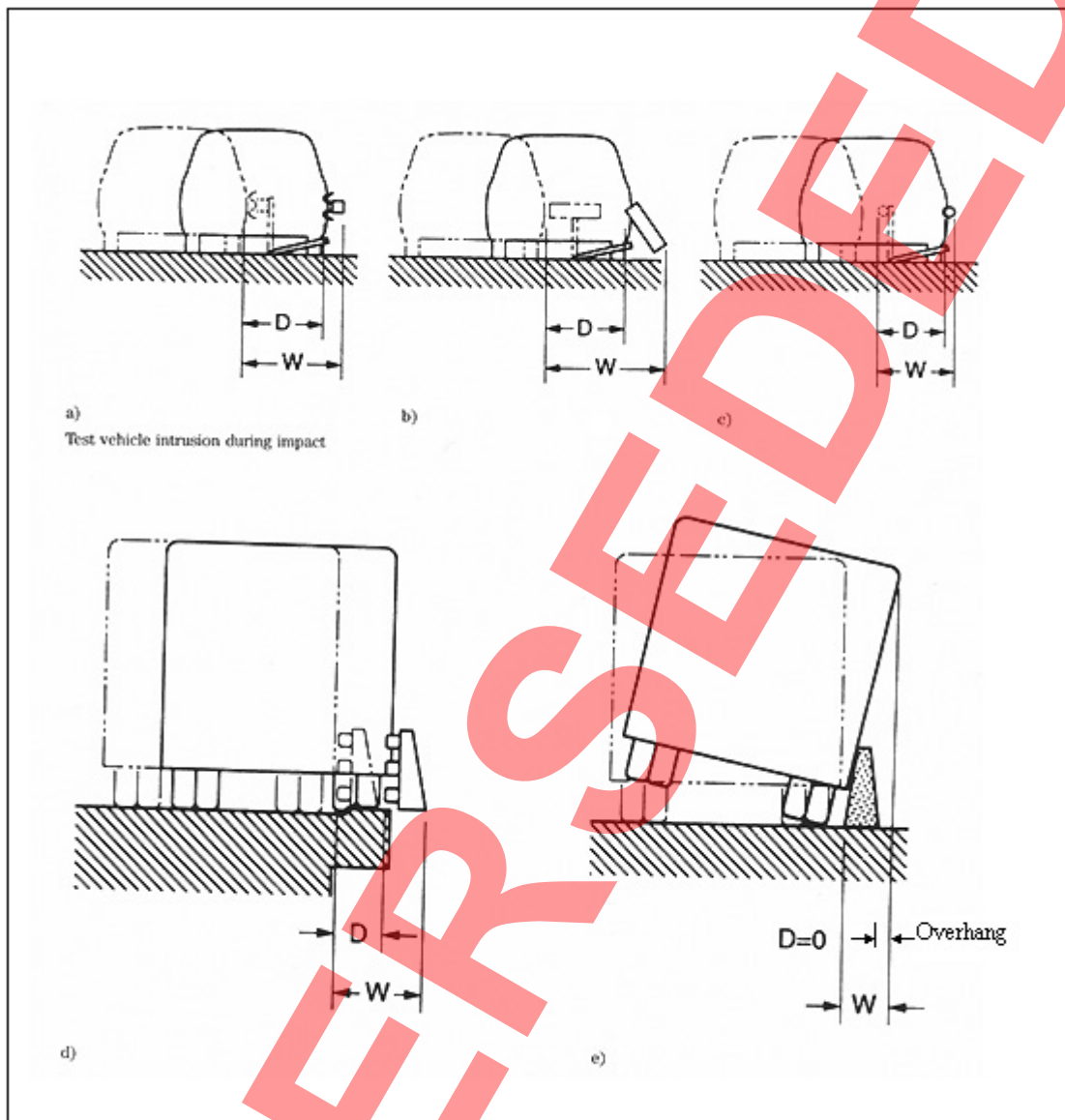


Figure 1-1 Dynamic Deflection (D) and Working Width (W)

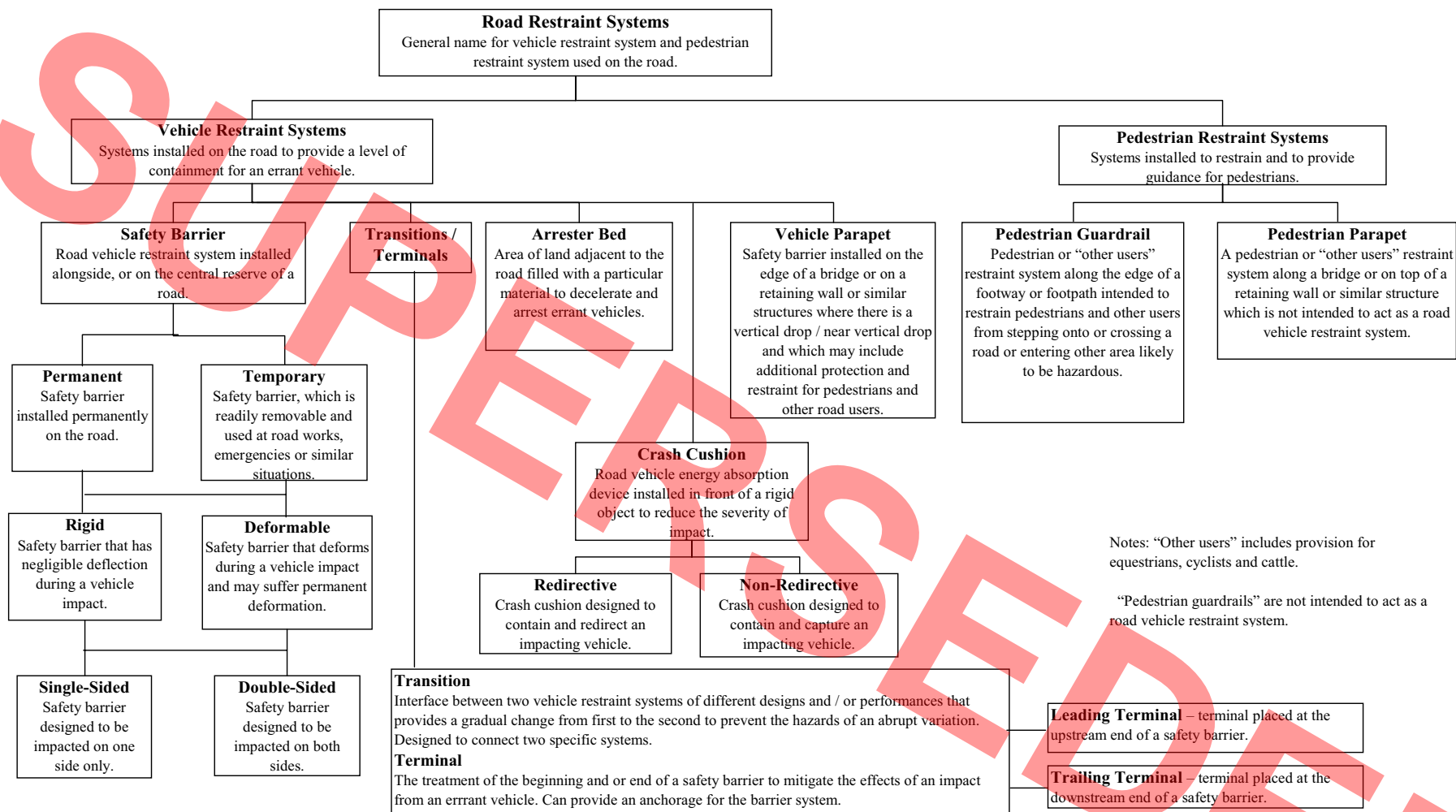


Figure 1-2 Road Restraint Systems Terminology and Definitions

## 2. OVERVIEW OF RISK AND MITIGATION AND CONSIDERATIONS FOR SELECTION

### Risk and its Mitigation

#### Introduction

2.1 There are many definitions of hazard and risk; for the purpose of this Standard, the following definitions shall be used.

**HAZARD:** A hazard is a feature (e.g. embankment) or object (e.g. lighting column) that can cause harm or loss. Harm or loss can be physical, financial or economic, strategic, or be time-based, or any combination of these.

**RISK:** A risk is the chance, high or low, that somebody or something will be harmed by the hazard.

2.2 In general terms, in this Road Restraint Systems (RRS) Standard, risk can further be described as the likelihood of the hazard being reached or hit by an errant vehicle (chance) multiplied by the resulting consequence if the hazard is reached or hit (harm). The hazard may be within or beyond the highway boundary. A risk may also occur if a hazard that is hit by an errant vehicle falls, or becomes detached and forms a projectile, and causes an injury to Others or causes further damage. The consequence may, for example, be: injury to an occupant of the errant vehicle; temporary loss of a strategic installation; adverse affect on Others; etc.

2.3 The previous Safety Fence and Barrier Standards (e.g. TD 19/85) and Interim Requirements for Road Restraints Systems (IRRRS) stated the control to be put in place to protect certain hazards.

2.4 The concept of risk management assumes that risks exist and must be controlled to an acceptable level by focusing on measures to be taken to eliminate or lower risk in targeted operations. The risk management framework is:

- (i) identify the hazards;
- (ii) assess the level of risk at each;
- (iii) decide on and implement appropriate action to eliminate, minimise or control the hazards and mitigate the risk.

2.5 Key to the process is that:

- (i) the decision must be taken and recorded. It must not be allowed to happen by default;
- (ii) the decision must be taken at the correct level in the organisation; if necessary, devolving responsibility to those who are best able to obtain and assess the evidence on which to base the decision;
- (iii) the decision taker must not be afraid of doing nothing, if to do nothing is the proper conclusion from following the Road Restraint Risk Assessment Process (RRRAP).

#### Assessing and Mitigating the Risk, and the ALARP Principle

2.6 Risk is measured in terms of both the individual risk to a person and the overall concerns of society it gives rise to. The triangular framework illustrated in Figure 2-1 represents decreasing levels of risk as a result of a particular hazard as we move from the top to the bottom of the triangle. At the top is the 'unacceptable' region. A risk falling into this region is regarded as unacceptable whatever the level of benefit associated with the activity.

2.7 An example might be if a bridge was built over a high speed road, but no parapet or safety barrier was provided. If an errant vehicle was to go over the edge of the bridge, there could be multiple casualties to the vehicle occupants and to Others on the carriageway below. With no vehicle restraint provided, it is probable that this type of event could occur and society does not tolerate multiple casualties, unless the risk of occurrence is extremely low. The risks, therefore, need to be lowered as far as reasonably practicable. The use of a low containment safety barrier or parapet could reduce this risk, and a higher containment barrier or parapet could reduce this risk still further; though, depending on the amount and mix of traffic, the additional cost of providing the higher containment may greatly outweigh the additional benefit of its provision and, therefore, be impracticable.

2.8 The region at the bottom of the diagram represents the ‘broadly acceptable’ risk. Risks falling into this region are regarded as minor or insignificant and adequately controlled. Further action will not usually be required. Money spent in further reducing the level of risk would be better spent elsewhere where a greater cost benefit could be realised. The levels of risk here are comparable to those that people regard as acceptable in every day life. An example of risk in this region might be the use of passively safe lighting columns placed at an optimum distance back from the edge of the road or the use of a Vehicle Restraint System (VRS) in front of a solid lighting column close to the running lane. Current best practice has been used to set the ‘broadly acceptable’ level within the RRRAP. Most situations designed in accordance with the guidance in this document should, therefore, give a ‘broadly acceptable’ level of risk.

2.9 The zone between the ‘unacceptable’ and ‘broadly acceptable’ regions is the ‘tolerable’ region. Risks in this region are typical of risks people are prepared to tolerate in order to secure benefits, in expectation that:

- (i) the risks are kept As Low As Reasonably Practicable (ALARP);
- (ii) the risks are reviewed to ensure they continue to be ALARP.

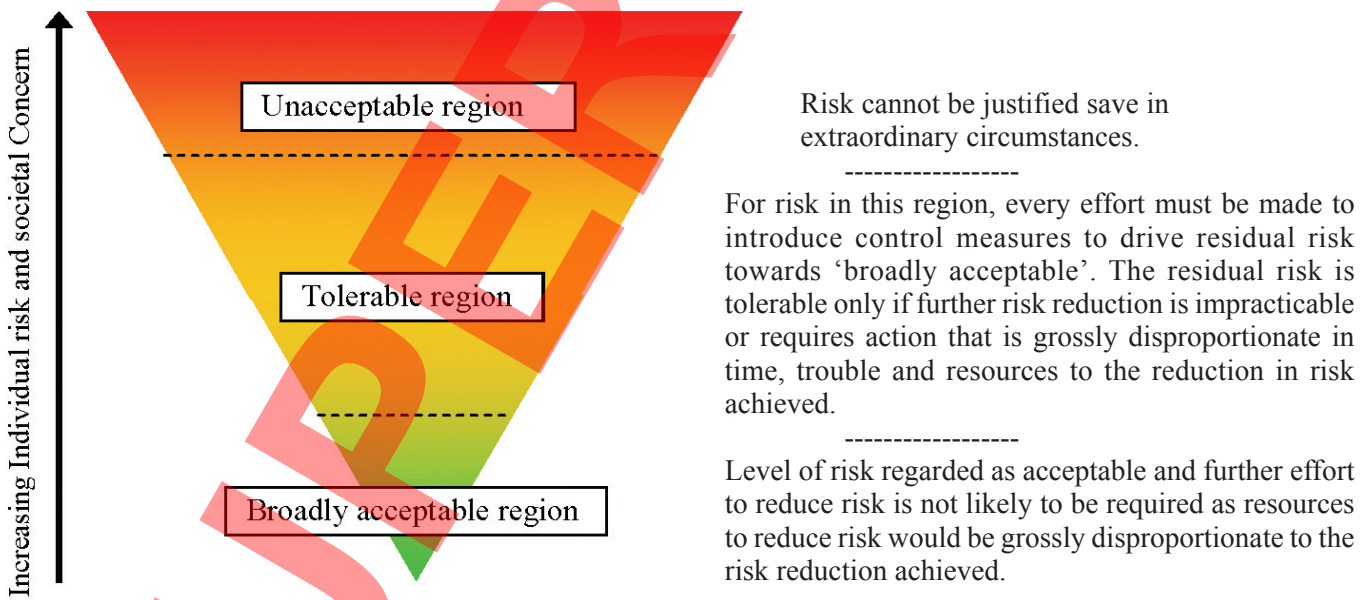


Figure 2-1

2.10 What does ‘reasonably practicable’ mean? In essence, the risk has to be weighed against the trouble, time and money (i.e. the overall cost) needed to control or remove it. Making sure a risk has been reduced ALARP is about weighing the risk against the overall cost needed to further reduce it. The balance to be achieved is weighed in favour of health and safety because the courts have ruled that to avoid putting a measure in place, it must be shown that the cost of the measure is grossly disproportionate to the benefit it would achieve.

2.11 If a risk falls into the 'unacceptable' or 'tolerable' region, then the risk must be lowered to a 'broadly acceptable' level or as far as reasonably practicable within the 'tolerable' region. The Designer must choose the design option with the lowest risk within the 'tolerable' region unless it can be shown that this option is not reasonably practicable, in which case attention must pass to the next lowest risk option. The procedure is repeated until the lowest risk option is found which is reasonably practicable. This approach is particularly useful in identifying step changes in risk and sacrifice between various options.

2.12 In the majority of cases, reviewing the questions given below will represent 'good practice' and aid in the production of a design that demonstrates that the risks are ALARP.

- (i) Can the hazard be removed, e.g. is it necessary to place the sign/gantry leg in that position?
- (ii) Can the hazard be relocated to a safer position, e.g. can it be relocated further from the running lane, or behind an existing safety barrier?
- (iii) Can the hazard be redesigned and made less aggressive, e.g. passively safe posts?
- (iv) Can the hazard be protected by a VRS?
- (v) Can the road layout or cross-section be revised to lower the risk, e.g. increase the width of the hard shoulder, improve road alignment, etc?
- (vi) Can other measures be taken to improve the situation, e.g. can a lower speed limit be imposed? This option is not viable for single objects, but may pose a solution if the risk needs to be lowered over a considerable length of a route because of constraints, e.g. motorway widening. A high level of confidence that a reduced speed limit will be achieved is needed before this measure can be used.

2.13 If, having reviewed all the options, a solution is found that produces a 'broadly acceptable' level of risk, then this option should be chosen. If a 'broadly acceptable' level of risk cannot be achieved because of constraints at the site, then an alternative solution or design might be needed. A Departure from Standard, as stated in Chapter 1 Paragraph 1.39, is required for any design that produces a risk that does not fall within the 'broadly acceptable' region.

2.14 There is no correct answer to "what is a reasonable level of risk on the highway?". Each decision taker is responsible for deciding if the proposed course of action is reasonable and, if necessary, for defending that decision in court.

### Cost Benefit Analysis

2.15 Cost Benefit Analysis (CBA) expresses costs and benefits in a common currency, usually money, so that a comparison can be made between different options. It is a defined methodology for valuing costs and benefits that enable broad comparisons to be made between different health and safety risk reduction measures on a consistent basis, giving a measure of transparency to the decision making process.

2.16 For the purpose of this Standard we are using a Benefit/Cost ratio (B/C) where:

$$B/C = \text{Monetary value of Net Benefits} \div \text{Cost of Provision, maintenance and/or mitigation measures.}$$

## The Road Restraint Risk Assessment Process

### Introduction

2.17 The software based RRRAP forms part of a risk management framework that will allow the level of risk from a hazard in or beyond the verge or in the central reserve to be calculated. The RRRAP will allow a review of the effect of various options on the associated risk level and, where appropriate, the B/C.

### Assessing the Risk

2.18 The RRRAP uses fairly simple formulae. It assesses risk as:

The **Likelihood** of an errant vehicle hitting a roadside hazard multiplied by the resulting **Consequence**.

The **Likelihood** of an errant vehicle hitting a hazard is based on the likelihood of it leaving the road, the distance of the hazard from the running lane, the nature of the ground the errant vehicle would have to cross, etc.

The **Consequences** are based on the speed of the errant vehicle and the aggressiveness of the hazard (i.e. the ability to do harm).

2.19 There is limited accident data to allow a comprehensive assessment of what the severity of an impact might be for all type of roadside hazards. Where available, data from research and Stats 19 has been used to make an assessment of the aggressiveness of hazards. Where no data exists, the aggressiveness factor has been set based on a combination of engineering and professional judgement.

2.20 In general, the higher the aggressiveness factor for a hazard, the higher the potential for harm. The aggressiveness is never zero, as all hazards have the potential for harm, but the severity alters. An RRS has a non-zero aggressiveness, as it will not eliminate risk but will lower the risk to the occupants of errant vehicles, compared with most hazards that are likely to be hit.

2.21 The total risk at a hazard is calculated as:

Total risk = risk to vehicle occupant(s) + risk to Others

The risk to vehicle occupant(s) used in the RRRAP is a mix of the risk to car, Medium Vehicle, and Large Goods Vehicle (LGV) occupants.

2.22 The % of Medium Vehicle traffic and % of LGV traffic using the road is used to calculate the risk posed by each of these vehicle classes. Within the RRRAP, a Medium Vehicle is classed as any vehicle greater than 1.5 Tonnes, and an LGV any vehicle greater than 3.5 Tonnes.

2.23 The RRRAP is not capable, at present, of assessing the risk to motorcyclists. Factors that must be considered in respect of motorcyclists are outlined in Chapter 3 Paragraphs 3.41 and 3.42.

2.24 The estimate of the risk to Others is based on the likelihood of an errant vehicle or hazard that it might hit reaching Others, and a broad estimate of the number of people exposed and the length of time for which they are exposed.

2.25 The total number of injury accidents at the site = traffic flow multiplied by the risk that an individual vehicle might hit a hazard resulting in occupant injury.

### Mitigating the Risk

2.26 The RRRAP will highlight if the risk is 'broadly acceptable', 'tolerable', or 'unacceptable'. It will not state how the risk should be mitigated, but will allow options to eliminate or control the hazards and/or to mitigate the risk to be tested and their impact on the risk level assessed and recorded. Options might include: removing or relocating the hazard; a change in, or redesign of, a hazard to make it less aggressive (e.g. making it passively safe, or smooth-faced); a change to the highway geometry or cross-section to reduce the probability of vehicle runoff and/or consequences; increasing the length of VRS; or a combination of these in order to maximise the B/C ratio.

2.27 A description of the RRRAP, the method of use and the key factors that it requires to be recorded is given at the end of this Chapter.

### Cost Benefit Analysis

2.28 The RRRAP uses a B/C ratio where:

$$B/C = \text{Monetary value of Net Benefit (i.e. reduction in accidents)} \div \text{Cost of Vehicle Restraint Provision, maintenance and or mitigation measures}$$

2.29 The RRRAP uses information in 'The Highways Economics Note No 1' (HEN1) as the basis for the values of prevention of road casualties and accidents for each injury category and road type. The average accident cost is estimated within the RRRAP, based on the aggressiveness of the hazard, vehicle speed, whether it would be a single vehicle accident or involve Others, and thereby an estimate of the average number of people injured. The Net Benefit is the reduction in cost due to the reduction in accidents due to the presence of the VRS.

2.30 The cost of VRS provision is based on the average cost per year per metre of provision and maintenance of the VRS over its life. (See Paragraphs 2.32 et seq. for further details).

2.31 When determining an appropriate Option, the Benefit/Cost ratio is a useful tool for assessing relative options for the provision of different RRS, but should not be used as a definitive measure.

### Benefit/Cost Ratio for Options that Involve Provision of Road Restraint Systems

2.32 The RRRAP defaults to show the risk level for a hazard both with and without a VRS. The default containment level for the VRS is Normal Containment Level N2. The RRRAP automatically uses a default value for the cost of the N2 Containment Level safety barrier over a 20 year life. If the use of an N2 VRS produces a 'broadly acceptable' level of risk, then the Benefit/Cost ratio can be used to assess the most practicable 'length of need'.

2.33 If the default N2 Containment Level VRS does not produce a risk that is 'broadly acceptable', then the options listed in Paragraph 2.12 must be reviewed. One option is to see if a higher containment level safety barrier, e.g. H1 or H2, can be used to lower the risk to a 'broadly acceptable level'.

2.34 The RRRAP also contains default values for the average cost per year per metre of provision and maintenance of other safety barrier containment level (i.e. N2, H1/H2, and H4a) based on a default life of 20 years. The default values for the cost of the VRSs and the assumed life of these Systems may be overwritten with actual System costs and serviceable life to give a more accurate Benefit/Cost ratio for the specific site.

2.35 This process is not to be used for assessing the Containment Level or CBA for parapets over railways; this must be done in accordance with Chapter 4 Paragraphs 4.6 and 4.7.

### Benefit/Cost Ratio for Other Options

2.36 As indicated in Paragraph 2.11, where the risk initially falls within the 'unacceptable' or 'tolerable' region, various design Options (i.e. other than VRS provision) will need to be assessed. It is recommended that a more detailed CBA of the various Options be carried out to allow the designer to consider, on comparable terms, the cost associated with each proposal. In practice, the designer may identify a number of Options where an assessment might show that costs are not grossly disproportionate. The Option or combination of Options, which achieves the lowest level of risk, should be chosen and implemented, provided grossly disproportionate costs are not incurred.

2.37 The RRRAP can be used to calculate the B/C ratio for each Option based on:

$$B/C = \text{Monetary value of Net Benefit (i.e. reduction in accidents)} \div \text{Cost of Provision of the Option.}$$

2.38 The Designer should enter the Cost of Provision of each Option ( $C_1, C_2, C_3$ , etc) into the RRRAP. This Cost should be the total estimated cost of providing the Option, including, for instance, the cost of measures to relocate a hazard, discounted (using standard principles) over an assumed life for the measure. Guidance on discounting of costs and which cost is used is given within the RRRAP.

2.39 The B/C ratio for each Option is calculated within the RRRAP as follows:

- (i) The user enters the cost per year of provision of the proposed Option ( $C_1$ ).
- (ii) The RRRAP calculates the accident cost saving (DA) and B/C using the formula  $B/C = DA \div C_1$ , where DA is the total cost of accidents when no action is taken, less the total cost of accidents when the design is based on the Option as proposed.

2.40 It is stressed that this technique does not provide the 'answer' but it is simply a tool to aid Designers in balancing the Cost of Provision against the accident cost savings to help select a design that is ALARP.

#### 2.41 Example of how benefit cost ratio can be used to determine the preferred option

Assuming the risk is the same, the most practicable option is reviewed using the B/C ratio, for example:

Option 1: the accident cost saving is £40K, and the cost of provision is £100K, the  $B/C = 40 \div 100 = 0.4$

Option 2: the accident cost saving is £100K and the cost of provision is £100K, the  $B/C = 1$

Option 3: the accident cost saving is £90K and the cost of provision is £60K, the  $B/C = 1.5$

Option 3, is the preferred option, as it has the biggest impact by reducing the cost of the accident with the lowest cost of provision.

#### 2.42 Examples of how different provisions would influence the Risk Assessment calculation:

- (i) If the hazard being considered is a traffic sign then, assuming it could not be displaced into the running lane if it were hit, the risk posed by this hazard is: risk to road users only. The sign poses no risks to Others (excluding the effect of the information on the sign no longer being visible).

If a Normal Containment Level (N2) safety barrier was provided, then this would reduce the risk of a car hitting the sign, have some effect on the risk to Medium Vehicles, but have only a partial effect on the risk of an LGV impacting the sign, as we assume that an N2 Containment Level safety barrier would not contain all the LGVs. The risk to LGV occupants would be low and probably produce a 'broadly acceptable' level of risk. Unless the LGV flow was high, the total cost of injuries would be low and the cost of further mitigation measures unlikely to be justified.

- (ii) If the hazard being considered is an underbridge, the risk posed by this hazard is: risk to cars + risk to Medium Vehicles + risk to LGVs from going over the edge of the bridge and reaching a hazard below + risk to Others below the bridge or on the bridge as a result of this event.

If an N2 Containment Level VRS was provided, this would reduce the risk to the car and Medium Vehicle occupants, and lower the risk to Others by reducing the likelihood of an errant vehicle going over the edge of the bridge. It would not affect the risk posed to the LGV occupants or substantially reduce the risk to Others of LGVs going over the edge. If the LGV flow was low and there were no other factors that would increase the likelihood of an errant vehicle impacting the VRS, then a 'broadly acceptable' level of risk to Others would probably be achieved by using a Normal containment N2 VRS.

If a Higher Containment Level (i.e. H1 or H2) VRS was provided, this would reduce the risk to the car occupants by containing the vehicle, although it might increase the severity from impact, but lower the risk to Others and to the occupants of Medium Vehicles and LGVs. However, if the risk to Others and Medium Vehicle and LGV occupants was low initially, the use of a Higher Containment Level H1/H2 VRS might have very small effect on reducing this risk further.

The option chosen should be the one that gives a 'broadly acceptable' level of risk. If this is not possible, then the option chosen should be the one that produces the lowest risk within the 'tolerable' region that is reasonably practicable. The B/C ratio should be used to assist in the determination of what is 'reasonably practicable'.

## General Information Required within the RRRAP

### Overview

2.43 An important function of the RRRAP is that of providing an audit trail for the Designer and Overseeing Organisation. The RRRAP is currently based on an MS Excel spreadsheet and uses 'drop downs' to facilitate data entry, and macros to assist in calculating and recording risk and cost benefit information for each of the options investigated. The RRRAP also requires the Designer to input information that is ancillary to the process of hazard identification and risk mitigation that provides background details for the audit trail.

2.44 The RRRAP will calculate risk and cost benefit levels for permanent safety barrier provision. At present, due to the complexities of the risk and cost benefit analysis for temporary situations, temporary safety barrier provision has not been modelled within the RRRAP. Instead, the Designer is required to respond to a series of questions that prompt the designer to identify the various factors that he needs to consider, weigh up and take account of in deciding whether a temporary RRS is warranted.

### Data Entry

2.45 The RRRAP is split into a number of worksheets grouped into the following categories.

- (i) **Basic Details.** This section records key details of the project for which the assessment of RRS requirements is being undertaken. It records details such as: Project name; Designer and company name; reason why the works are being done, e.g. upgrade or improvement to an existing carriageway or replacement of existing RRS; type of road; its location in terms of junction names or numbers, which side of the carriageway is being looked at, and start and end chainages of the section being assessed; traffic and, where available, accident data; date of submission and date of the Road Restraint Standard used in the assessment.
- (ii) **Features Listing.** This section is used to identify whether or not any hazard listed in each category of hazard is present in the length of road verge (or central reserve) being assessed. The hazard categories are generally based around the numbering system used in the **MCHW, Volume 1**. Help menus are available to assist the user in determining what items are covered in each hazard category. The Features Listing worksheet links into a series of Hazard Data Entry worksheets, one for each category of hazard. For example, fencing hazards are entered in the '300 Fencing' worksheet, drainage hazards in the '500 Drainage' worksheet, earthworks hazards in the '600 Earthworks' worksheet, etc. These worksheets are where detailed information about each hazard is entered.

- (iii) **Hazard Data Entry worksheets.** Details of the type of hazard, e.g. street sign, its start chainage, length and width, offset and other relevant information is entered. The offset of each hazard and safety barrier is referenced relative to a standard point, namely the point from which set-back is measured in TD 27. In this Standard this point is called 'Psb'. The RRRAP automatically assigns a reference number and aggressiveness to the hazard that is based on a default value for the type of hazard. Information for each hazard within each hazard category is entered in a similar way. Once all the required data has been input, a 'risk calculation' button is pressed and a macro is started. The macro automatically collates and sorts all the entered data into chainage order and computes the Length of Need of VRS in advance of and beyond each object, and hence the total Length of Need, and the associated risk and cost benefit levels.
- (iv) **Option Evaluation.** The risk and cost benefit calculations in the RRRAP are based on where the traffic and the hazard are relative to Psb. For a motorway with a standard width hardshoulder, the normal running lane will be 3.3 m from Psb. The designer will be able to test, for instance, the effect on the total Length of Need of safety barrier of: moving the hazard further back from Psb; changing it to be less aggressive (e.g. using a passively safe sign post rather than a standard one); having a reduced width hardshoulder; or having no safety barrier.
- (v) **Recording Results.** The RRRAP can be used to record the various Options looked at and the chosen Option for each hazard. In some cases, this might mean no Vehicle Restraint provision. The RRRAP will also facilitate data entry (using manual copy and paste) into the format needed for typical contract documentation under Appendix 4/1 of MCHW, Volume 2 – Series NG 400.

### Considerations for Selection of Road Restraint Systems

2.46 VRS are commonly known as crash barriers and are primarily used to protect vehicle occupants from impacting road furniture or hazards or reaching opposing carriageways. Much research and investigation has been carried out over the years and this has led to the development of the BS EN 1317 which has drawn together best practice and developed a standard way of testing and evaluating the performance of VRS. BS EN 1317 allows Systems tested under the same conditions to be compared and acts as a compliance test to determine good from inadequate systems.

2.47 No vehicle impact with a barrier is the same as another. Vehicles differ in mass, shape, rigidity and impact barriers at different angles and speed. A barrier tested to BS EN 1317 will not tell you how it will perform when impacted by all errant vehicles, but it will give confidence as to how it will perform in the majority of cases. The performance of the barrier in terms of impact will vary according to the location of the installation, the ground conditions, specialist environmental considerations, etc. It is also important that the life cycle of the barrier is considered.

2.48 Figure 2-2 summarises the general factors that need to be taken into account by the designer/contractor when selecting suitable VRS for most situations. Further guidance on particular factors relating to specific situations is given in the text in the various Chapters of this Standard.

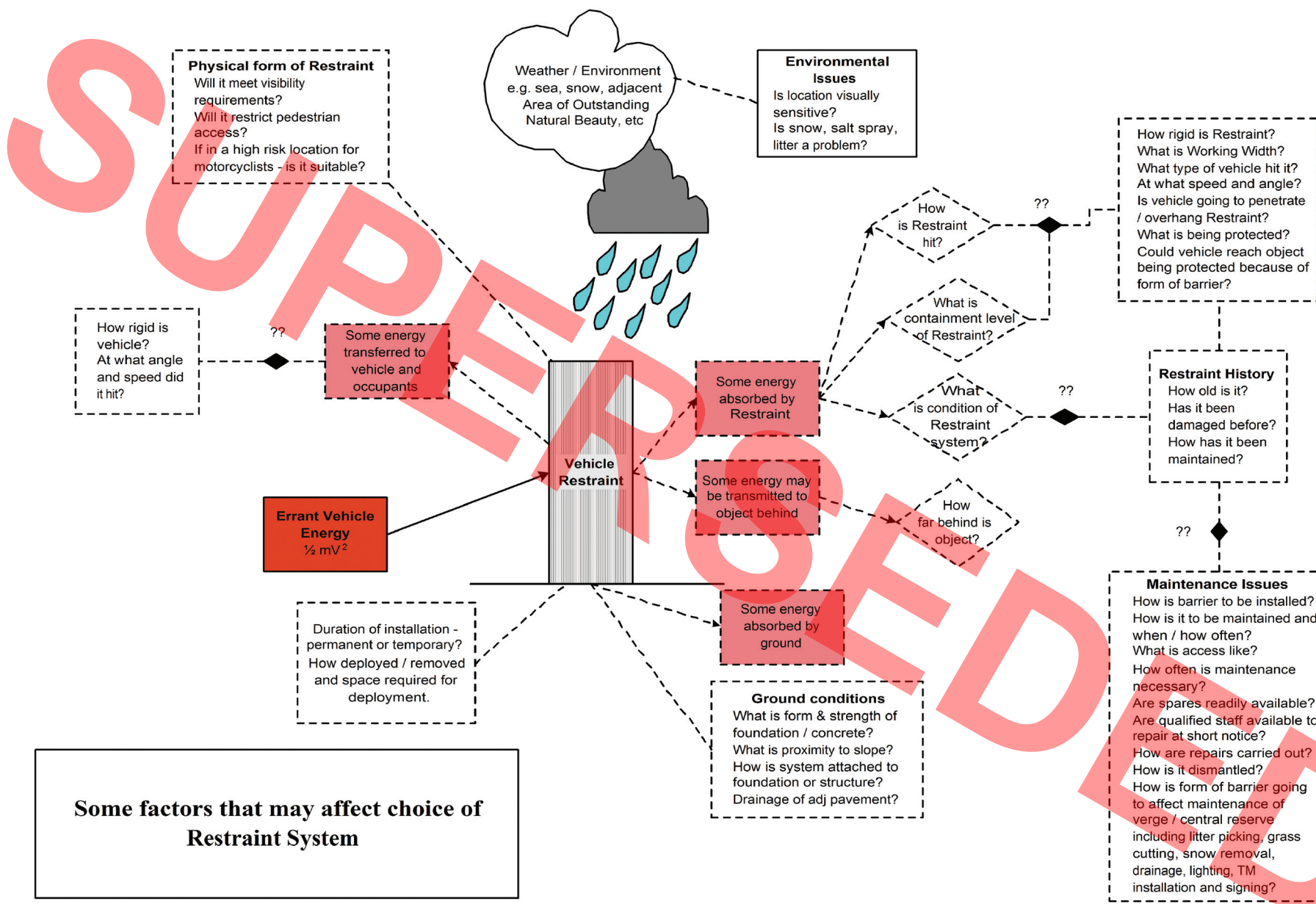


Figure 2-2

### 3. CRITERIA AND GUIDANCE FOR THE PROVISION OF PERMANENT SAFETY BARRIERS

#### Performance Class Requirements

##### General

- 3.1 All safety barriers installed must be compliant with the Test Acceptance Criteria requirements of BS EN 1317-2 and the following criteria.
- 3.2 The Design Organisation must specify the required Performance Class for each safety barrier installation in terms of Containment Level (e.g. N1, N2, H1, H2 or H4a), Impact Severity Level (ISL) (e.g. ISL Class B) and the Working Width Class (W1 to W8).
- 3.3 The Design Organisation must identify any special requirements with regard to the provision of safety barriers which may affect the choice of system by the Contractor, such as the maximum height of safety barrier that allows sufficient visibility. Examples are given in Paragraph 3.110.

##### Containment Levels

- 3.4 The containment levels requirements for safety barrier are:

###### Permanent Deformable and Rigid Safety Barriers:

- (i) **On roads with a speed limit of 50 mph or more:**
- (a) Normal Containment Level = N2
  - (b) Higher Containment Level = H1 or H2
  - (c) Very High Containment Level = H4a
- (ii) **On roads with a speed limit of less than 50 mph:**
- (a) Normal Containment Level = N1

- 3.5 Where the Road Restraint Risk Assessment Process (RRRAP) or the requirements below indicate a containment level that is higher than the minimum, as indicated in Paragraphs 3.4(i)(a) or (ii)(a), is required, the higher containment level must be specified.

##### Impact Severity Levels (ISL)

- 3.6 The ISL for safety barriers must not normally exceed Class B as stipulated in BS EN 1317-2.
- 3.7 At specific locations where the containment of an errant vehicle (such as a heavy goods vehicle) is the prime consideration, or where there is limited space available, a Vehicle Restraint System (VRS) may need to be installed with an ISL greater than Class B. The use of VRS with an ISL greater than Class B must be with the agreement of the Overseeing Organisation and justified by the RRRAP. Where an ISL level greater than Class B is to be used, the limits  $ASI \leq 1.9$  and  $THIV \leq 33$  km/h shall apply.

### Working Width Class

- 3.8 The Working Width Class for each safety barrier installation must be the same as or less than that specified by the Design Organisation.
- 3.9 The Design Organisation must specify the greatest Working Width Class that the local highway geometry will allow. (See Paragraph 3.93 for Guidance).
- 3.10 Where the Working Width Class for a proposed System is based on an update to EN 1317:1998, a check must be carried out to ensure that there is sufficient clearance between the hazard being protected and the restraint system that is proposed, to ensure that the hazard will not be hit by a vehicle intruding beyond the restraint system (see Chapter 1 Paragraph 1.49 et seq.).

### General Requirements

#### General

- 3.11 Permanent Deformable or Rigid Safety Barriers must be provided where the outcome of the RRRAP indicates that a VRS is necessary.
- 3.12 The Design Organisation must identify local hazards, within or immediately adjacent to the highway, that need to be examined through the RRRAP. These are hazards that may cause a danger to the occupants of an errant vehicle or give rise to a secondary event were the vehicle to reach the hazard. In addition, the risk of an errant vehicle to Others must also be examined.

The following is a list of hazards that must be identified within the RRRAP. This list is not exhaustive and other hazards should be considered.

- (i) Above ground structural supports, bases or foundations which are positioned less than 3 m above the adjacent paved carriageway. The chance of reaching a hazard that is greater than 3 m above the paved carriageway is thought to be very low, but if there are any reasons or conditions at the site that the Designer believes will make it possible for the hazard to be reached, the hazard should also be identified.
- (ii) Drainage culvert headwall.
- (iii) Restricted headroom at a Structure or part of a structure (See Figure 3-10 and TD 27 [DMRB 6.1.2]).
- (iv) A retaining wall which does not have a smooth face adjacent to the traffic extending for at least 1.5 m above the adjacent carriageway level. A 'smooth' face may include a surface that may have an irregular surface finish subject to the maximum amplitude of the steps and undulations in the surface not exceeding 30 mm when measured with respect to a plane through the peaks. The plane must be broadly parallel to the road alignment. A structure that has a 25 mm wide chamfered construction joint in its surface would be regarded as smooth.
- (v) An exposed rock faced cutting slope, rock filled gabions, crib walling or similar structures (See BD 68 [DMRB 2.1.3]).
- (vi) Soil cutting slopes and earth bunds greater than 1 m high and with a side slope gradient of 1:1 or steeper.
- (vii) Embankments and vertical drops.
- (viii) Strengthened or geotextile reinforced slopes.

- (ix) Environmental noise barriers or screens.
- (x) Highway boundary fences and walls.
- (xi) Dwarf retaining walls surrounding hazards such as drainage access manholes and communication cabinets.
- (xii) Permanent or expected water hazard with depth of water 0.6 m or more, such as a river, reservoir, stilling pond or lake or other hazard which, if entered, could cause harm to the vehicle occupants.
- (xiii) Road lighting columns, though see further guidance in Paragraphs 3.123 to 3.125 below.
- (xiv) High mast road lighting columns.
- (xv) Sign and signal gantry supports.
- (xvi) Sign posts not meeting the requirements of BS EN 12767 which exceed the equivalent section properties of a tubular steel post having an external diameter of 89 mm and a nominal wall thickness of 3.2 mm.
- (xvii) Large signs (typically those higher than 2 m) located in a position where the fascia could be struck by an errant vehicle.
- (xviii) Above ground communications control cabinets, pillars and equipment (other than emergency telephones), CCTV Masts (See **BD 83 [DMRB 2.2.1]**, Telephone Masts (See **TA 77 [DMRB 9.5.1]**).
- (xix) Stores for emergency/diversion signs and similar permanent structures.
- (xx) A tree or trees having, or expected to have, trunk girths of 250 mm or more (measured at a height of 0.3 m above ground level) at maturity (see Guidance Paragraph 3.130 et seq.).

Hazards where Others could be affected:

- (i) Non-motorised User (NMU) subway entrance or agricultural underbridge passing under the highway.
- (ii) A railway, canal or separate road or carriageway.
- (iii) Public meeting places where a number of people would be present for some time such as schools, hospitals, recreational, retail facilities or factories.
- (iv) Chemical works, petroleum storage tanks or depots, facilities manufacturing or storing hazardous materials in bulk.

3.13 The RRRAP must be used to determine if a safety barrier is required to protect each single hazard identified or, where there are a number of hazards that are in close proximity, the group; and, if a safety barrier is required, then to determine the Length of Need for the single hazard, or group thereof to produce a risk that is 'broadly acceptable'. Note that some safety barrier systems may require additional lengths to function as intended.

3.14 Road furniture and equipment must not be positioned in front (i.e. within the set-back) of a new or existing Road Restraint System (RRS) and, in general, it should not be placed immediately in advance of nor within the available Working Width of a new or existing RRS (as it can affect the way the RRS performs) unless the road furniture or equipment has been designed to be passively safe and, if hit, will not be displaced into the adjacent carriageway or give rise to a secondary event, and the circumstances outlined in Paragraphs 3.66 to 3.69 dealing with Relaxations and Departures are met.

3.15 The safety barrier layout must be carefully planned to minimise the number of approach ends of safety barriers, as the ends themselves are a hazard. Where new safety barriers are required and gaps of 50 m or less arise between two separate safety barrier installations, where practicable, the gap must be closed and the safety barrier made continuous. Further Guidance is given in Paragraph 3.107 and 3.108.

3.16 The treatment and positioning of the ends of safety barriers must also be carefully considered to minimise the risk they impose. For further guidance on the end treatment of safety barriers, see Chapter 5, Guidance on Terminals.

3.17 The Design Organisation must ensure that the site is inspected prior to carrying out the RRRAP.

3.18 The Design Organisation must ensure that during construction works the original design assumptions are valid. If the original design assumptions are not valid, the Design Organisation must carry out the RRRAP again and ensure that the new requirements are provided. This is particularly important at embankment side slopes, at the transitions between cut and embankment or start of sidelong ground, at locations where there are hazards present that may affect Others, and on curves where there may be subtle details present that are not apparent from drawings and which are difficult to model in the RRRAP.

### Visibility

3.19 The requirements stipulated in TD 9 [DMRB 6.1.1] in respect of visibility, sightlines over and in front of safety barriers and Stopping Sight Distances must be complied with.

3.20 In difficult situations where the horizontal and/or the vertical alignments or other physical features prevent the establishment of the appropriate Stopping Sight Distance requirements stated in TD 9, the Design Organisation must apply to the Overseeing Organisation for a Departure from TD 9.

### Set-Back

3.21 Set-back at permanent systems must be in accordance with TD 27. The relationship between set-back and Working Width at hazards in verge and central reserve is given in Figure 3-4.

3.22 Any proposal to reduce set-back from the values required in TD 27 must be accompanied by a Risk Assessment identifying the factors considered, their likely combined effects and justification for the proposal and be included in an application for a Departure from Standard to the Overseeing Organisation.

3.23 Some terminals protrude proud of the traffic face of the general run of the VRS and, therefore, set-back should be measured to the part of the VRS closest to the traffic face. Further guidance is given in Paragraph 3.96.

3.24 On central reserves where there are no hazards and there is only one double-sided deformable safety barrier, or rigid safety barrier between the carriageways, the set-backs on both sides of the safety barrier must not be less than as stipulated in TD 27 nor less than the Working Width Class of the safety barrier minus the actual width of the safety barrier (See also Figure 3-3). This is to ensure that the safety barrier will not encroach into the opposing carriageway if hit.

3.25 Set-back greater than the minimum values stipulated in TD 27 should be provided where space allows and as described in that document.

**Minimum Lengths of Safety Barrier**

3.26 If the Length of Need determined using the RRRAP is less than the minimum length of “full height” safety barrier in advance given in Table 3-1, then the minimum length must be provided. In addition, at least the corresponding minimum length of “full height” safety barrier beyond the single hazard, or group thereof, given in Table 3-1 must also be provided.

3.27 Where the traffic can travel in both directions along the same carriageway, either under normal conditions or under temporary traffic management such as contraflow (either now or at some future time), the RRRAP must be used to determine whether the minimum Length of Need of safety barrier beyond that given in Table 3-1 is sufficient under these conditions. The greatest of the lengths of need so determined must be used; however, where the Length of Need for the temporary situation is longer than the Length of Need for normal conditions, the extra Length of Need may be provided only for the period that the temporary situation is operative, or it may be provided as a permanent solution.

3.28 The safety barrier provided to protect a single hazard, or group thereof, must be a continuous length that may or may not be made from one type of product (e.g. a metal safety barrier – concrete safety barrier – metal safety barrier would constitute a continuous length).

Safety Barrier Containment Level	MINIMUM “full height” lengths of safety barrier <sup>1</sup>	
	In advance of hazard	Beyond hazard
Normal (N2 or N2)	30 m	7.5 m
Higher (H1 or H2)	30 m	10.5 m
Very High (H4a)	45 m	18 m

**TABLE 3-1**

Notes: 1. These are minimum lengths. Manufacturers may require longer lengths than specified above. (Refer to Chapter 1 Paragraph 1.42 Length of Need.)

3.29 Where the constraints of the site make it physically impossible to install the required lengths of safety barrier, the maximum achievable lengths must be recorded together with the results of the RRRAP relating to the actual situation and full details of the alternatives examined together with the justification for the proposed lengths, must be forwarded to the Overseeing Organisation for their consideration as a Departure from Standard.

**Provision at Vehicle Parapets**

3.30 Where a vehicle parapet is required, a safety barrier must be provided to prevent direct impact with each approach end of the vehicle parapet. The Performance Class of the parapet and VRS may differ. At each approach end of the vehicle parapet, the safety barrier must be full height for at least the minimum length in advance for the Containment Level of the safety barrier stated in Table 3-1 and must continue the line of the traffic face of the vehicle parapet. The minimum length may include the length of any transition between the parapet and safety barrier.

3.31 Where traffic can travel in both directions, either under normal conditions or under temporary traffic management such as contraflow, a safety barrier must be provided at each end of the parapet in accordance with Paragraph 3.30. If traffic can only flow in both directions under temporary traffic management, then the safety barrier provided at the end that is normally the departure end of the parapet may either be permanent or only installed for the duration of the Works. When the temporary situation ceases, the minimum length beyond the hazard specified in Table 3-1 shall remain.

3.32 A transition must be provided between the safety barrier and the vehicle parapet. The parapet must be capable of resisting forces applied from the safety barrier or transition. Refer to Chapter 6 for details of requirements for transitions.

3.33 The RRRAP must be used to determine whether the minimum Length of Need of safety barrier in advance given in Table 3-1 is sufficient under the conditions stated in Paragraphs 3.30 and 3.31. If the Length of Need determined from the RRRAP is greater than the minimum length given, then the Length of Need from the RRRAP must be provided. See also Chapter 4 Paragraph 4.37 relating to provision at railways.

#### Provision at Sign or Signal Gantry

3.34 Sign and/or signal gantries are not generally designed to withstand full vehicle impact and, therefore, may collapse on impact by an errant vehicle and cause a secondary event including falling into the carriageway. Therefore, unless the RRRAP indicates, due either to the offset of the sign gantry or signal gantry or to other factors, such as the gantry being passively safe, that Normal Containment Level (N2) is sufficient or that no safety barrier is required, then the minimum containment level must normally be Higher Containment Level (H1). Details of the containment level required in given situations are shown in Figure 3-9.

#### Non-motorised Users

3.35 Consideration must be given to the movement of NMUs, e.g. pedestrians, cyclists, equestrians and farm animals, along the verge on all-purpose roads, and pedestrians (e.g. broken down motorists) on hardshoulders of motorways.

3.36 At some locations on all-purpose roads, there may be a defined movement of equestrians/farm animals along the verge and the Design Organisation must ensure any proposed safety barrier installation allows for such movement (See TA 90 [DMRB 6.3.5] and TA 91 [DMRB 5.2.4]).

3.37 A staggered overlapped gap for NMUs must be provided where possible in any verge safety barrier at emergency telephones (see TA 73 [DMRB 9.4.2]) as shown in Figure 3-11 and opposite a central reserve NMU crossing gap as shown in Figure 3-14. Any such gap must have a full height overlap, of at least 9.5 m between the two adjacent safety barriers, such that an errant vehicle cannot impact the leading terminal of the downstream safety barrier. A clear width as given in TA 90 must be maintained through the staggered gap to allow the free movement of NMUs.

3.38 The face of a safety barrier adjacent to NMUs should not present a hazard for NMUs, including the visually or mobility impaired. A light non-participating guardrail, post and rail end caps, etc may be required to protect the NMUs from sharp edges where possible, etc where a designated NMU route is present. The Design Organisation should check with the safety barrier manufacturer that any such proposed protection will not invalidate the tests on the safety barrier.

3.39 It should be noted that, unless there is a very significant risk, for instance, at a point where large numbers may congregate regularly for significant periods of time, it is not normally the case that a safety barrier is provided for protection of pedestrians and other NMUs. Whilst it is preferable for NMU routes to be located completely beyond the Working Width of the safety barrier, it will often be the case that there is insufficient space available. The NMU route should, therefore, be located as far from the rear of the safety barrier as is reasonably practicable.

3.40 Where there is a significant pedestrian movement and the need to channel the movements has been established, consideration should be given to the provision of a separate pedestrian guardrail behind the safety barrier (See Chapter 9 and TA 91).

### Motorcyclists

3.41 At sites identified, e.g. through accident records, to be high risk to powered two-wheel vehicles, such as tight external bends, consideration must be given to the form of VRS chosen to minimise the risk to this category of driver. Any special requirements must be stated in the contract.

3.42 At such high risk sites, it is recommended to use an 'add on' motorcycle protection system to post and rail type safety barriers to minimise the risk of injury to motorcyclists. The Design Organisation must check with the safety barrier manufacturer that any such proposed protection will not invalidate the tests on the safety barrier. Such 'add on' products must be approved by the Overseeing Organisation and be compatible with the safety barrier to which it is being attached as these products are not included within BS EN 1317.

### Drainage and Kerbs

3.43 Consideration must be given to the form and design of the carriageway, verge and central reserve drainage and its maintenance and to the interaction of the drainage with the safety barrier systems to ensure satisfactory performance of both.

3.44 When considering the use of surface water drainage channels and or kerbing, the Design Organisation must evaluate the safety aspect in relation to the position of any safety barriers and the relevant set-backs (see HA 37 [DMRB 4.2], HA 83 [DMRB 4.2.4] and HA 119 [DMRB 4.2.9] and MCHW-3 Series B and F). Consideration must be given to their placement in terms of the safety of two-wheeled powered vehicles (see HA 83).

### Verges and Central Reserves

#### Provision in Verges and Central Reserves – General

3.45 The verge and central reserve below and immediately adjacent to the safety barrier should be nominally flat.

#### Provision in Verges – General

3.46 Figures 3-4 to 3-10 show the general layout of safety barriers adjacent to hazards.

3.47 Figure 3-12 shows the minimum taper lengths required at changes of horizontal alignment of verge and central reserve safety barriers. Advice should be sought from the VRS manufacturer about the particular systems to confirm that these lengths are adequate.

3.48 Figure 3-10 shows the requirements where there is restricted headroom at a structure. (See TD 27 [DMRB 6.1.2])

3.49 Where the RRRAP indicates that a safety barrier will be required and the safety barrier will be placed adjacent to a slope, reference should be made to Figures 3-1 and 3-2 which show the relationship of the safety barrier to the top of embankments and sidelong ground and toe of cuttings in verge and central reserve situations.

3.50 On carriageways that are divided/separated (e.g. when one carriageway has been constructed a distance from the other to take advantage of the ground profile to minimise cut/fill or to improve alignment) the Design Organisation must assess the need for safety barriers and record any findings using the RRRAP, and agree the provision of safety barriers with the Overseeing Organisation.

3.51 Any safety barrier installation in the vicinity of a Motorway Police Observation Platform should be in accordance with the requirements of TA 66 [DMRB 6.3.2]. Where the Police have agreed that the Observation Platform is no longer required it should be removed.

3.52 At exposed rock faced cuttings slopes, additional rock netting may be required behind a safety barrier to prevent falling rocks from reaching the hardstrip, hardshoulder and or carriageway, see Paragraph 3.104 et seq. of the Guidance section.

#### Provision at Nosings

3.53 Nosings, where one carriageway diverges from another, are areas that are particularly prone to runoff accidents. There is always a balance to be struck between (a) the need to place signs, lighting columns or other street furniture in the vicinity of a nosing and protect them from errant vehicles, (b) keeping the area free of all hazards (including safety fencing), whilst discouraging deliberate overrunning of the nosing area, and (c) keeping within the physical horizontal and vertical constraints of the location.

3.54 A flat area, ideally free of all hazards, of around 10m length should be maintained at the back of nosing. (See TD 22 [DMRB 6.2.1] and Figure 3-13).

3.55 Where it is necessary to install street furniture or other hazards, these should be kept to a minimum and ideally be passively safe in accordance with TA 89 [DMRB 8.2.2]. They should be placed as far from the point of the physical nose as practicable. Where passive safety is not possible and safety barrier protection is required to protect the hazards (including the level difference between the adjacent carriageways), sufficient space along and across the nosing area should be allowed for any safety barriers, terminals and the required Working Widths and set-back.

#### Taper Lengths at Changes in Horizontal Alignment of Verge and Central Reserve Safety Barrier

3.56 Taper lengths should be greater than the minimum wherever practicable. Taper lengths, as described in Figure 3-12, are required to ensure that:

- (i) there is a flowing alignment along the length of safety barrier;
- (ii) any changes in angle of the safety barrier presented to oncoming traffic (i.e. the approach angle) are not going to be significantly different in effect on an errant vehicle or on the safety barrier to the angle(s) of approach at which the safety barrier has been tested;
- (iii) the safety barrier change in direction does not give rise to a 'pocketing' effect (see Chapter 6 Paragraphs 6.9 to 6.13);
- (iv) changes in profile of a safety barrier do not occur abruptly.

### Provision in Central Reserves – General

3.57 A safety barrier must be provided on dual carriageway roads where the width of the central reserve measured between opposing edges of carriageway road markings (or kerb faces where no markings) is 10 m or less. Where the central reserve is wider than 10 m, the Design Organisation must assess the need for safety barriers and record any findings using the RRRAP, and agree the provision of safety barriers with the Overseeing Organisation.

3.58 The placement and nature of hazards in the central reserve and form of safety barrier must be chosen to minimise the need for operatives to work in the central reserve.

3.59 On motorways or roads constructed to motorway standard with a two-way AADT greater or equal to 25,000 vehicles/day where a VRS is required in accordance with Chapter 1 Paragraph 1.18(i), the safety barrier must be a rigid concrete safety barrier with an H1 or greater Containment Level. This is to minimise cross-over accidents and reduce the need for safety barriers to be repaired or maintained and hence, minimise the costs and congestion arising from temporary traffic management and reduce the risk to maintenance workers. Where the Overseeing Organisation agrees that road lighting columns, signals or signs may be mounted on the rigid concrete safety barrier, the Working Width Class must be increased to reflect the additional width of safety barrier required to accommodate the column or post and its fixings. In Scotland and in Wales the specific use of rigid concrete safety barriers, in such circumstances, is not mandatory and any proposals for the use of such safety barriers in central reserves must be referred to Transport Scotland or the Welsh Assembly Government for consideration.

3.60 Where the provision of a rigid concrete safety barrier to meet the requirements of Paragraph 3.59 is considered impracticable, a Departure from Standard with full justification must be provided. Examples of when a Departure from Standard is needed are: if a structure cannot support a rigid concrete safety barrier system, or where a Departure from TD 9 for reduced visibility has not been approved.

3.61 The use of an H1 rigid concrete safety barrier may not be practicable for lengths of 500 m or less. Therefore, where the provision of a rigid concrete safety barrier to meet the requirements of Paragraph 3.59 would, in total, be 500 m or less and where the Exception in Chapter 1 Paragraph 1.18(iii)(b) cannot be applied, Normal Containment Level N2 safety barrier may be used.

3.62 A safety barrier must be provided on both sides of a hazard except where road lighting columns, signals, gantry legs or signs are to be mounted on a rigid concrete safety barrier. Figure 3-6 shows the layout of central reserve safety barriers adjacent to hazards where single sided safety barrier is provided. Figure 3-7 shows the layout of central reserve safety barrier adjacent to hazards where a double-sided safety barrier is provided. See Paragraphs 3.98 and 3.130 to 3.132 for further guidance on trees.

3.63 Where a safety barrier is required in accordance with Paragraph 3.57 and there is a difference in the opposing edge of carriageway levels of 200 mm or more and there are no hazards in the central reserve or sightline requirements, the safety barrier must be installed adjacent to the higher carriageway. A separate safety barrier adjacent to the lower carriageway may also be required due to the height difference between the carriageways, the ground profile across the central reserve and the type/design of safety barrier chosen (See Figure 3-2).

3.64 Other than under Paragraph 3.57 where it has been agreed with the Overseeing Organisation that no safety barrier is required, there must be no gaps in the central reserve safety barrier on Motorways. Gaps in central reserve safety barriers on the Trunk Road network must be closed wherever possible and, on other dual carriageway roads, gaps in an otherwise continuous central reserve safety barrier must be restricted to the absolute minimum necessary for the efficient operation and management of the road.

3.65 Paragraphs 3.70 to 3.92 identify a number of situations where gaps may be required in central reserve safety barriers.

## Relaxations and Departures

### Relaxation for Locating a Hazard Within the Working Width or in Front of a Vehicle Restraint System

3.66 Where space is limited and it can be shown that the requirements of Paragraphs 3.67 and 3.68 have been followed, the following Relaxations may be applied.

3.67 A Relaxation may be used to locate furniture meeting the requirements of **TA 89 [DMRB 8.2.2]** within the Working Width of a single-sided VRS in the verge, as long as it is demonstrated that:

- (i) furniture cannot be located outside the Working Width of the existing VRS; and
- (ii) a VRS with a sufficiently small Working Width cannot be used; and
- (iii) passively safe furniture cannot be used without a safety barrier (for instance when a safety barrier is required to protect other hazards as well); and
- (iv) if the furniture were to be hit it would not be displaced into the running lane or a position that could cause a secondary incident.

3.68 A Relaxation may be used to permit the location of signposts (excluding signposts with slip bases) meeting the requirements of **TA 89** within the Working Width of a single sided VRS in the central reserve as long as it is demonstrated that:

- (i) the sign cannot be placed outside the Working Width of the system; and
- (ii) a system with a smaller Working Width cannot be used; and
- (iii) a passively safe sign cannot be used without a safety barrier; and
- (iv) if the sign were to be hit or contacted by the safety barrier, it would not be displaced into the running lane of either carriageway or a position that could cause a secondary incident.

3.69 Where the above Relaxations cannot be used, a Departure from Standard may be considered to locate furniture meeting the requirements of BS EN 12767 in front of a single sided VRS in the verge (see Paragraph 3.100 of the Guidance section for further information), as long as it is demonstrated that:

- (i) furniture cannot be located behind a VRS and outside the Working Width of the system; and
- (ii) a VRS with a sufficiently small Working Width cannot be used; and
- (iii) the furniture does not/would not touch the safety barrier if hit or act as a ramp over the VRS (see Guidance Paragraph 3.100); and
- (iv) the furniture cannot be displaced into the running lane; and
- (v) the setback to the furniture is not less than 600 mm.

## Requirements for Gaps in Central Reserve

### Emergency Crossing Points

3.70 Overseeing Organisation policy is that Emergency Crossing Points (ECPs) are generally deprecated unless it is demonstrated that there is an overwhelming need. Justification for a new ECP on Highways Agency Trunk Roads must be in accordance with the criteria set out in IAN 68 'Emergency Access to and Egress from the HA network'.

3.71 On motorways meeting the requirements of Paragraph 3.59 where rigid concrete Higher Containment Level H1 or H2 or Very High Containment Level H4a safety barrier is provided, a VRS with a minimum Containment Level of H1 must be used for any ECP. The provision of an ECP increases the need for maintenance and repair in an otherwise continuous rigid concrete safety barrier and, therefore, their use must be minimised. Designers must ensure that the transition from the rigid concrete safety barrier to the 'gate' or other system is acceptable in terms of safety and containment and that the working width of the ECP does not encroach into the opposing carriageway. A Departure from Standard is not required for the installation of any such system in an H2 or H4a rigid concrete safety barrier.

3.72 Where an ECP exists on a road which is to be improved or will be subjected to major maintenance, the Design Organisation, in conjunction with the Overseeing Organisation, must discuss with the relevant Emergency Services, the need for the ECP to be retained.

3.73 The ECP must be designed to a minimum length of 16 m and maximum length of 25 m. Greater lengths may create operational difficulties. To determine the dimensional requirements of the crossing point, a location specific swept path analysis should be undertaken during the design stages. The same layout as for tunnels may be adopted, (see Figure 3-16).

### "Open" Emergency Crossing Points

3.74 All essential "open" ECPs, which are retained following discussions with the Emergency Services, should preferably be gated and must be closed with a row of traffic cylinders of at least 600 mm in height which comply with Diagram 7103 of the Traffic Signs Regulations and General Directions (TSRGD) and of the Traffic Signs Regulations (Northern Ireland). Cylinders must be spaced at a maximum of 1.0 m centres between the end terminals of the safety barriers.

3.75 To enable an "open" ECP to be identified, special verge marker posts and central reserve reflectors must be erected on each approach at approximately 300 m, 200 m and 100 m from the ECP (See MCHW-3: Highway Construction Details Section 1, Series 'E' Drawings).

3.76 The general layout of an "open" ECP must be in accordance with Figure 3-15. At all "open" gaps in the central reserve safety barrier, the alignment of the two opposing sections of safety barrier and their end terminals must be such that an errant vehicle impacting the safety barrier prior to the gap is directed away from and not towards the leading terminal of the downstream safety barrier wherever practicable.

3.77 See Guidance section Paragraphs 3.112 to 3.122 for further information on ECPs and Maintenance Crossing Points (MCPs).

### Maintenance Crossing Points and Maintenance Access

3.78 To facilitate contraflow traffic flows during schemes and tunnel maintenance, it may be necessary to establish MCPs in the central reserve and create gaps in the safety barrier (see TA 92 [DMRB 8.4.6]). The temporary end terminations to the existing safety barrier installation must satisfy the Performance Class requirements detailed in this Chapter whilst the gap is open.

3.79 For tunnels, which are an unusual situation, the routine maintenance regime may require the MCP to be regularly opened, contraflow operated and the MCP closed within a short period. The safety barrier used to close the gap must have a minimum Containment Level equal to that of the adjacent safety barrier, the layout in Fig 3-16 applies. Further guidance is given in Paragraphs 3.112 to 3.117.

3.80 For other situations, on completion of the works, any MCP gap(s) must be closed by re-instating the original safety barrier(s) or a replacement system of an equivalent Containment Level and Working Width Class to that which was removed (see Chapter 5 of TA 92). Any 'above ground' elements of the temporary end termination(s) of the safety barrier must be removed. Suitable transitions must be used between the permanent sections of safety barrier and 'removable' sections and temporary end termination(s).

3.81 At some locations such as at a grade separated interchange, there may be a requirement for maintenance vehicles or plant to gain access behind a safety barrier. In such cases, a staggered overlapped gap in the safety barrier installation (i.e. in the direction of traffic flow) may be justified.

### Requirements for an ECP/MCP

3.82 The safety barrier system for an ECP/MCP must be specified in terms of Containment Level and Working Width Class.

3.83 For motorways, where concrete H1, H2 or H4a Containment Level safety barrier is used, the safety barrier system used for an MCP/ECP must be H1 Containment Level or greater.

3.84 For all other roads, the Containment Level at the ECP/MCP must be equal to or greater than that of the adjacent safety barrier e.g. if the safety barrier is N2, then the ECP/MCP must also have a minimum N2 Containment Level.

3.85 Suitable transitions of the same Containment Level as the normal VRS will be required between the VRS and the ECP/MCP system.

3.86 The Working Width Class of the ECP/MCP must not be greater than the highway geometry will allow, (see Paragraph 3.24).

3.87 The maximum acceptable time for opening and closing the MCP must be agreed with the Overseeing Organisation. See Guidance Section for further information.

### Winter Maintenance Crossing Points

3.88 At locations which are frequently subject to severe winter weather conditions (e.g. heavy snowfalls), the provision of a Winter Maintenance Crossing Point (WMCP) in the central reserve should be considered. A lockable gate or barrier should be provided across the gap to preclude unauthorised use of the WMCP (See Figure 3-17 as an example of an existing facility).

3.89 A WMCP should only be considered where the width of central reserve is such that the largest type of maintenance vehicle and associated equipment that is likely to be deployed can be safely positioned transversely between the carriageway and the gate, and the gate opened without encroaching into the set-back of either carriageway.

3.90 It will be necessary to erect the appropriate signs and provide traffic cylinders (complying with Diagram 7103 of The Traffic Signs Regulations and General Directions 2002 (S.I. 2002 No. 3113) and of the Traffic Signs Regulations (Northern Ireland) 1997) at 1.0 m (maximum) centres adjacent to each carriageway edge to limit misuse of the WMCP by non-maintenance vehicle drivers.

### Other Gaps in the Central Reserve

3.91 On the immediate approaches to Major/Minor side road junctions (see TD 42 [DMRB 6.2.6]), the width of the central reserve will often be reduced to allow the provision of a turning lane. This narrowing to the central reserve width, together with the requirement to provide essential visibility sight lines on all approaches of the junction, may preclude the installation of safety barriers over part, or all, of the length where the central reserve width has been reduced. The Design Organisation should seek to avoid omission of safety barrier at junctions on new roads and minimise the omission on existing roads. The siting of street furniture should be carefully considered to ensure that either it is adequately protected by the safety barrier, or not in a location to cause a hazard to the road users, or that it is made passively safe in these situations. (See Paragraph 3.66 et seq.).

3.92 Where a safety barrier is to be installed on an existing all-purpose Trunk Road, the Design Organisation must establish and agree with the Overseeing Organisation, whether there is a need to provide a gap in the central reserve safety barrier (e.g. for a farmer to gain access to an adjacent field). The use of such gaps must be minimised and alternative means of vehicular access must be examined. See TD 41 [DMRB 6.2.7].

## Guidance

### General Guidance

#### Working Width Class

3.93 As an example of the greatest Working Width Class that the local highway geometry will allow, if the room available is 1.6 m, this falls in between Classes W4 and W5 (where W4 is  $\leq 1.3$  m and W5  $\leq 1.7$  m), so the greatest Working Width Class that the geometry will allow is W4.

#### Containment Levels

3.94 At certain high risk locations the use of a Higher Containment Level (H1/H2) or Very High Containment Level (H4a) VRS may be justified. Such high risk locations will be identified through the RRRAP (see Chapter 2 Paragraph 2.17 et seq.). The Design Organisation should demonstrate within the RRRAP how the risk at such locations could be mitigated, the steps taken to reduce the risk to a 'broadly acceptable' level and the required containment level.

3.95 Factors such as the cost of a hazard, and its replacement and the safety implications of the loss if the hazard under assessment should not be available or out of action for a period of time, should be taken into consideration. Examples might be an MS4 sign (a variable message sign) that displays safety messages, if it was removed from service as a result of an impact, would this cause an increased safety risk? If so, then a higher containment VRS may be required to protect it. The RRRAP cannot determine such risks and therefore, any increase in Containment Level should be justified and specified by the Designer. Note that some above ground communications equipment controls significant amounts of automatic signing, such as Active Traffic Management, loss of which due to an accident could

have very severe consequences over a wide area. Loss of other above ground communications equipment may have a relatively limited effect. The Design Organisation should, therefore, ascertain the significance of these items of equipment to ensure that adequate protection is provided.

### Set-back

3.96 Hazards immediately adjacent to the edge of the paved carriageway result in drivers reducing speed and positioning their vehicles away from the hazard. The purpose of the set-back is to provide a lateral distance between the VRS, such as a safety barrier, and the carriageway which reduces the effect of the VRS on driver behaviour and edge shyness. Further guidance is given in TD 27 [DMRB 6.1.2]. Some P4 energy absorbing terminals protrude proud of the traffic face of the general run of the VRS and, therefore, set-back should be measured from the part of the VRS closest to the traffic face. Where space is tight, a shallow flare of the terminal may be necessary to ensure that the set-back requirements are achieved to all parts of the VRS. The Contractor should check with the VRS manufacturer and ensure that the proposed flare is acceptable and will not invalidate the VRS's 'certified' performance.

3.97 Reducing set-back can exacerbate the likelihood of impacts and side-swipes between vehicles in adjacent lanes; give rise to dangers to any pedestrians, cyclists, etc; difficulty with opening doors on broken down vehicles; and reduced space for maintenance vehicles and operatives.

### Location of Hazards Relative to the Carriageway or Running Lane

3.98 The distance of a hazard from the running lane and the nature and profile of the intervening ground will influence the probability of an errant vehicle or struck reaching the hazard. For example, a hazard on or beyond a shallow embankment will be more likely to be reached than one at a similar distance in a cutting. Shallow ditched open channels in the verge will tend to slow errant vehicles and direct them back towards, or parallel with, the carriageway rather than towards hazards that are beyond the channel. The roughness of the intervening ground and nature of vegetation on it may have a limited effect on probability of a hazard being reached. Bushes and trees are subject to maintenance regimes and may be thinned, cut back or even removed; there is also the possibility of fire damage, so their presence cannot necessarily be relied on.

3.99 It should be noted that movement of a hazard further from the running lane will give drivers more chance of recovering the situation, avoiding collision and decreasing the severity of a collision. If the gap between the hazard and the safety barrier provided to protect it increases correspondingly, there will be a greater chance of an errant vehicle passing behind the safety barrier, increasing the Length of Need required to provide adequate protection. Movement of both the safety barrier and hazard further from the running lane reduces the likelihood of an impact with the safety barrier, and generally minimises the Length of Need to provide adequate protection to the hazard, although the offset also influences the range of angles of impact which can affect the severity of the impact against the safety barrier. The amount of movement available for the safety barrier will depend on its Working Width, the verge width and the slope profile beyond the back of verge, (refer to Figure 3-1 and Figure 3-2 for details of the allowable proximity of safety barrier to top or toe of slopes). The location of the hazard, set-back, available verge width, and Working Width of the RRS are, therefore, closely interlinked. The optimum solution in terms of hazard location and safety barrier location, Length of Need and Working Width is assessed through the RRRAP.

### Location of Road Furniture or Hazards Relative to Safety Barrier

3.100 Placing hollow section posts or columns in front of a safety barrier will interfere with the correct redirection operation of the safety barrier if impacted by an errant vehicle. It will also increase the probability of collision with the posts or columns. As detailed in Paragraph 3.69 relating to Departures from Standard, a post that has been designed to be passively safe may be positioned in front of a safety barrier if the furniture does not/would not touch the safety barrier if hit, or act as a ramp over the VRS. However, most conventional passively safe posts and lighting columns do not meet this requirement as, when they collapse during impact, they collapse towards the safety barrier, and this may create a ramp which may allow the vehicle to travel over the safety barrier. The type of passively safe systems that could be used are those where the posts are pivoted, such that if hit at any angle they always collapse parallel to the safety barrier and, therefore, present no risk of a ramp effect.

3.101 Objects should not normally be placed within the Working Width as this will affect the performance of the safety barrier. The objects are likely to be impacted and may also have a detrimental effect on the vehicle hitting it and will increase the risk of injury to its occupants. Passively safe sign posts designed in accordance with TA 89 [DMRB 8.2.2] will behave differently to conventional street furniture and it may be beneficial to use them in this situation - refer to that Standard and to Paragraphs 3.126 to 3.128 below for guidance. There has been no testing done with passively safe posts and columns positioned within the Working Width of safety barriers and, therefore, this combination must only be used where there is no other solution to lower the risk as low as reasonably practicable. It is recommended that any passively safe signpost or column is placed a minimum of 600 mm from the back of the safety barrier and be placed centrally between any supports of the VRS to allow the barrier to absorb most of the energy of a vehicular impact.

#### Location of Safety Barrier in Relation to Structures, such as Abutments and Other 'Smooth' Walls

3.102 A safety barrier is required to prevent an errant vehicle impacting the end of a structure or abutment. In most cases, only a normal containment safety barrier is provided and this safety barrier is not intended to provide protection for the structure. However, it is important to ensure that the structural integrity of a structure that, for instance, fails the assessment requirements of BD 48 [DMRB 3.4.7] is maintained following an impact, i.e. that the structure should not collapse, but local damage to a part of the bridge deck, for example, could be accepted. If the structure is designed for impact load to BD 60 [DMRB 1.3.5] and has a smooth face (see Paragraph 3.12 (iv)) such that a vehicle hitting it would not be snagged or redirected into the carriageway, it is acceptable to place the safety barrier in line with the face of the structure to prevent impact with the ends or corner of the structure. Abutments are not normally considered for vehicle collision as they are assumed to have sufficient mass to withstand the collision loads for global purposes (see BD 60). In the same way as for structures, if the abutment has a smooth face, it is acceptable to place the safety barrier in line with the face of the abutment to prevent impact with the ends or corner of the abutment. This may be the preferable option where there is limited space in front of a structure, see Figure 3-8. Alternatively, a safety barrier could be placed in front of the structure/abutment, e.g. in cases where it is not possible to create a smooth face.

3.103 It is important when connecting safety barrier to an abutment or similar wall to ensure that there is a gradual change in stiffness of the safety barrier as it approaches the structure. If the change in either is too abrupt, there is a possibility that an errant vehicle hitting the safety barrier would cause a 'pocketing' effect. This is where the safety barrier deflects significantly more than the stiffer structure that it is connected to, leading to the vehicle hitting the end of the abutment or wall. See also Paragraph 3.56 and Chapter 6 Paragraph 6.9 et seq. In order to prevent this, a suitable transition should be provided.

#### Location of Safety Barrier in Relation to Exposed Rock Faced Slopes

3.104 A common means of capturing falling rocks at exposed rock faced slopes is the installation of rock netting. This would be installed vertically or at a slight incline towards the road, and behind any safety barrier that is present. One of the advantages of this arrangement is the ability of the rock netting to absorb, by distortion, some of the energy of the falling rocks. Another advantage is that any arrested debris is relatively easy to monitor. However, on the assumption that a safety barrier is to be installed at the same location as the rock netting, the lateral space for each VRS to perform correctly needs to be taken into account. If fallen rocks encroach into the Working Width of the safety barrier, then there is the prospect of a vehicle not only impacting the safety barrier but also the rock netting and any accumulated debris. This could result in an impact more severe than if only the safety barrier had been involved and there is also the possibility that the vehicle could become unstable and spin out into the live carriageway.

3.105 The safety barrier itself should not be used to contain falling rocks. This could result in:

- (i) damage to the rear of the safety barrier which is difficult to assess;
- (ii) a serious constraint to the ability for the safety barrier to deflect, invalidating its 'certified' performance.

Any significant modification of the safety barrier (netting between posts, high netting attached to the safety barrier, etc.) would again invalidate the certified performance.

3.106 Inspection and maintenance of both the rock retaining system and the safety barrier are essential to ensure correct performance of both the safety fencing and rock netting fencing.

### Closing of Short Gaps Between Safety Barrier Installations

3.107 Short gaps between two separate safety barrier installations should be avoided unless they are required for access, as the terminal section of a safety barrier presents more of a hazard to vehicles than the length of full height safety barrier used to close the gap. The longer the gap, the less the benefit gained in closing it. At present, it is required that gaps of less than 50 m should be closed. It might also be practicable to close gaps up to 100 m; this will depend on the site and the proposed end terminals being considered.

3.108 Where a gap between safety barrier installations cannot physically be closed due to the safety barriers being at different offsets, it may be acceptable to overlap the two installations. It is not acceptable if a vehicle (travelling in either direction on two way roads or contraflow situations) that hits the first safety barrier could be directed into the leading terminal of the second safety barrier or into the hazard that the second is protecting.

### Guidance on Factors Regarding Choice of Restraint System

3.109 The choice of Restraint System will normally be made by the Contractor based on the performance criteria specified. Any special requirements should be detailed in the contract documentation to ensure that suitable systems are selected.

3.110 When specifying, designing and installing safety barriers, consideration should be given to the following:

- (i) Proximity of other services (e.g. drainage, communications and utilities) (See TD 27 [DMRB 6.1.2]) and the need to access these for maintenance.
- (ii) Maintenance of the safety barrier system, the verge/central reserve (e.g. grass/surface material) and street furniture and equipment, including provision for mounting temporary signs, especially in the central reserve.
- (iii) Drainage of the adjacent carriageway, verge and or central reserve, e.g. it may be necessary to provide drainage 'weep' holes through a solid rigid safety barrier. Advice of the System manufacturer should be sought to ensure that such holes would not invalidate the safety barrier Certification or compromise its durability.
- (iv) The need to specify the maximum amount of vehicle intrusion over the safety barrier that can be allowed. N.B. it is necessary to identify locations where vehicle intrusion is critical in determining the Working Width and to ensure that the contractor is aware of the need for manufacturer's stated Working Width to include vehicle intrusion when selecting a VRS, (refer to Guidance on Working Width in Chapter 1 of this Standard). The Working Width quoted in the Highways Agency's list of acceptable VRS includes vehicle intrusion unless stated otherwise.
- (v) Sightline requirements, e.g. the effect of the height of the safety barrier on stopping sight distance.
- (vi) Environmental considerations: e.g. snow, where a solid safety barrier may give rise to unacceptable levels of drifting; or marine environments where steel or aluminium products may be subject to high levels of corrosion.
- (vii) The requirement for the system to be readily removed at emergency or maintenance crossing points, see below for guidance.
- (viii) The need to limit the dead loading applied by the system to a supporting structure.
- (ix) The need to limit the impact loading applied by the system to a supporting structure.

- (x) The effectiveness of safety barrier systems when developing improvement or maintenance schemes. Where pavement overlays are to be undertaken in the future, particular consideration should be given to the height of the safety barrier above the adjacent carriageway surface. Guidance on the range of heights over which safety barrier is effective should be sought from the safety barrier manufacturers and assumptions made stated in contract documents to ensure that provision is adequate. Note that construction tolerances on safety barrier heights would be insufficient to permit pavement overlays without repositioning the safety barrier.
- (xi) The implications on future traffic management layouts, e.g. it may be desirable to provide slots in concrete safety barrier for temporary signs.

## Guidance on Provision in Verges and Central Reserves

### Length of Restraint

3.111 It is very difficult to model accurately in the RRRAP all the factors that might influence the Length of Need for every situation. There have been cases at both cuttings and embankments where an errant vehicle has managed to pass behind a safety barrier and hit a hazard that the safety barrier was there to protect. The site inspections are, therefore, an essential part of ensuring that assumptions made during the design process remain valid, that changes are made where necessary and that adequate length of safety barrier is provided. Site inspections will be needed during the design and construction phases.

## Guidance on the Requirements for Gaps in Central Reserve

### Emergency and Maintenance Crossing Points

3.112 There are various options available to create an ECP/MCP. They may take the form of a gate or a permanent safety barrier. Each option varies in cost and ease of operation. Systems that are not suitable to be removed should be avoided near ECPs and MCPs.

3.113 For ECPs, the main requirement is the speed with which the ECP can be opened and operational; this will depend on the option chosen. It will also depend on whether specialist equipment or personnel are required to operate or open the ECP. In most cases, a time of less than 30 minutes to open the gate or dismantle a permanent safety barrier would be desirable (See IAN 68 for details).

3.114 For MCPs, speed may not be an issue as the opening can be planned. Where regular maintenance is required, for example, near tunnels or on long structures, then it may be beneficial to provide permanent MCPs at each end that can be opened and closed quickly. For other situations, there are two options. Provide an MCP from the outset, or create an MCP only when required (i.e. take down or break out the permanent system; this can often be the most cost effective solution).

### Gates at MCP/ECP

3.115 A gate is the easiest to open, generally requires no, or minimal, specialist equipment and can be opened in less than 30 minutes. However, personnel do need to be trained to ensure that they know how to operate the gate and close it properly so that it is correctly fixed to the permanent or temporary safety barrier when not in operation. Gates are generally quite expensive. They also have large Working Widths that can make them unsuitable for narrow central reserves (e.g. W5+). If they are used, where there is a mismatch in the working widths between the gate and the permanent system (e.g. Gate is W5 and concrete H2 safety barrier is W2), a transition is required to connect the two systems. Any transitions will increase the length of the MCP. (See Figure 3-16 for typical details).

3.116 Consideration should be given to the length of the openable leaves of the crossing safety barrier (and hence, the overall length of the crossing) such that, when in the open position, the requisite number of lanes are protected by the safety barrier.

3.117 Consideration should also be given to the means by which the openable leaves are opened and the effect that length may have on the practicability of opening and closing, especially when it is likely that the maintenance crossing facility will be used infrequently.

### Permanent Safety Barrier at ECP/MCP

3.118 A permanent safety barrier may be used to form an ECP/MCP.

3.119 If this option is chosen for an ECP, specialist personnel and equipment may be required to dismantle or remove the safety barrier and this can take some time and may exceed the normal 30 minute recommendation required for operational reasons. For an MCP it is a viable option.

3.120 Where a concrete H1 or H2 safety barrier is used, an MCP can be created by breaking out the concrete and removing the debris. This operation might take some time depending on length and require specialist equipment. An in-situ concrete section can then be inserted when the MCP is no longer required.

3.121 If the central reserve safety barrier is metal, socketted posts should be used to allow the permanent safety barrier to be dismantled and reinstated quickly (this may not be applicable for all Systems). The time for these operations will vary depending on the System and, if used, can mean a lot of repair work to reinstate the safety barrier. Therefore, this makes this suitable for an MCP, but not an ECP.

3.122 Whenever a section of safety barrier is removed, the ends of the safety barrier must be made safe in accordance with this Standard (e.g. terminals, crash cushion provided, or transition and openable gate/leaf of safety barrier).

### Guidance on Other Parameters

#### Lighting Columns

3.123 As an alternative to 'conventional' lighting columns, such as planted concrete columns or planted or flanged tubular steel columns, passively safe road lighting columns meeting the requirements of BS EN 12767 may be considered.

3.124 Consideration should be given to mounting the lighting columns in the verges rather than in the central reserve to keep the central reserve as maintenance free as possible.

3.125 The performance of some types of passively safe lighting columns may make them unsuitable for use in certain situations. For instance, on the elevated approaches to bridges and structures as depending on the form of design, they, or part thereof, could collapse onto a hazard below causing a Secondary Event more serious than the original event. Also they should not be used in central reserves or similar situations.

#### Signs

3.126 It is not acceptable in terms of safety barrier provision for designers to reduce the size of sign support posts by providing an increased number of posts (unless a passive safety support structure system is used in accordance with BS EN 12767), solely to overcome the requirement to provide a safety barrier. As the spacing of posts supporting a sign decreases, there is an increasing tendency for more than one post to be hit by an errant vehicle and for the sign and posts to act together as a relatively stiff and rigid hazard, thus significantly increasing its aggressiveness and hence, potential to cause damage to an errant vehicle and injury to its occupants.

3.127 There can be significant safety benefits in the use of passively safe signs, however, care must be taken in their placing as they can suffer from metal fatigue caused by vibrations from buffeting by strong winds and turbulence from large vehicles passing close by. The use and siting of such signs should be carefully considered, particularly in areas prone to high winds, to avoid such problems.

3.128 Passively safe signs should not be used where there is a vehicular path that could lead to the sign being knocked towards the road, e.g., unprotected parallel road with a sharp bend and a vehicle goes through the wooden boundary fence into the sign.

3.129 Highway signs on posts of more than 7 m in height, i.e. the vertical distance from top of post to bottom of flange plate or top of foundation whichever is the lesser, require technical approval, see **BD 2 [DMRB 1.1.1]**.

### Trees and Other Vegetation

3.130 Trees are a potential hazard and, therefore, need to be considered within the RRRAP. In previous standards, only trees with a girth of 300 mm or more have been classed as a hazard. If the tree girth was measured and it was less than 300 mm this often meant it was excluded and not protected with a safety barrier even though it might grow to >300 mm within its life. To ensure that this does not occur, all trees should be considered a hazard unless it can be shown that they would not reach 250 mm girth (note different dimension) at maturity. If the tree is to remain and is expected to exceed 250 mm girth at maturity, then the maximum size should be used to assess the need for and placement of the VRS to ensure that the Working Width of the safety barrier is not compromised when it grows. The designer should consider the worst case in the RRRAP. In some cases, it may be better to remove young trees that would not pose a current risk and replant them at a safer distance from the running lane. However, a check should be made on why they were planted, for example, are they part of a visual screen or planted where they are due to land constraints?

3.131 Trees are an important biodiversity asset and amenity and should not be removed without prior agreement by the Overseeing Organisation; they may also be subject to a Tree Preservation Order. They might also provide a visual screen, earth work stabilisation, wind protection or mask another hazard e.g. railings. Consideration should be given to all these factors. Where it is agreed a tree may be removed, it should be cut flush with ground level. Removal of stumps to ground level will require chemical treatment to ensure there is no re-growth; the same applies for removal of young trees.

3.132 Vegetation within the Working Width of the safety barrier will affect its performance. It will also hinder maintenance and create problems for the drivers of broken down vehicles who may seek temporary refuge behind the safety barrier. Where space exists, trees and other vegetation should be placed as far from the kerb face or back of hardstrip or hardshoulder as practicable (see **HA 56 [DMRB 10.1.2]**). However, where practicable, the following is recommended, for climax trees (e.g. Oak) 9 m, medium trees (e.g. Birch) 7.5 m, small trees (e.g. Malus) 5 m, and shrubs 4.5 m from the edge of the carriageway.

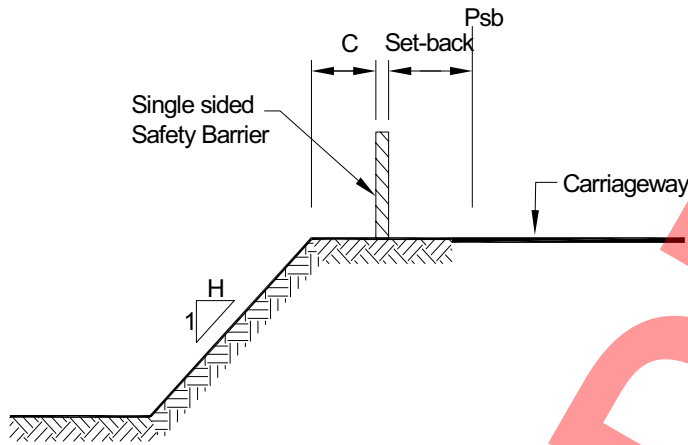


Figure 3-1 (a). At Embankments and Sidelong Ground Where Ground Slopes Down Behind Barrier.

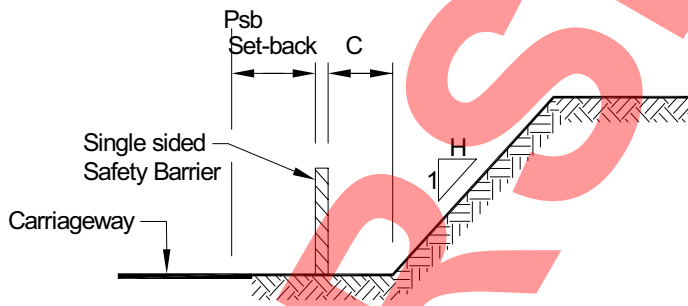


Figure 3-1 (b). At Cuttings

Notes

1. P<sub>sb</sub> = point from which set-back is measured (see TD 27).
2. The following conditions apply
  - a) Where the slope (1 in H) is shallower than or equal to 1 in 3, the dimension C may be less than the Working Width Class of the safety barrier, but not less than 600 mm.
  - b) Where the slope (1 in H) is steeper than 1 in 3 but shallower than or equal to 1 in 2, the dimension C must not be less than the greater of 0.75 times the Working Width Class of the safety barrier and 600 mm.
  - c) Where the slope (1 in H) is steeper than 1 in 2, the dimension C must not be less than the greater of the Working Width Class of the safety barrier and 600 mm.
  - d) On embankments and sidelong ground where the proximity of the safety barrier to the top of the slope and / or the ground conditions are likely to affect the integrity of the barrier, the advice of a Geotechnical Engineer must be sought and in-situ tests undertaken to verify the integrity of the barrier and its foundation. The advice and results of tests must be recorded.
3. General
  - a) The restrictions on dimension C are to ensure that (i) in cuttings, the barrier will perform satisfactorily and will not be affected by the slope behind it, and (ii) on embankments and sidelong ground, the ground is sufficiently strong to resist the forces that an errant vehicle and safety barrier may give rise to and also, when deflecting during a collision, that an errant vehicle is not adversely affected by the slope.
  - b) Refer to Figure 3-4 and Paragraphs 3.21 to 3.25 for details of Set-back requirements

Figure 3-1 Minimum Distances of Safety Barrier from the Top and Toe of Slopes at Verges where Safety Barrier is Required for Other Reasons

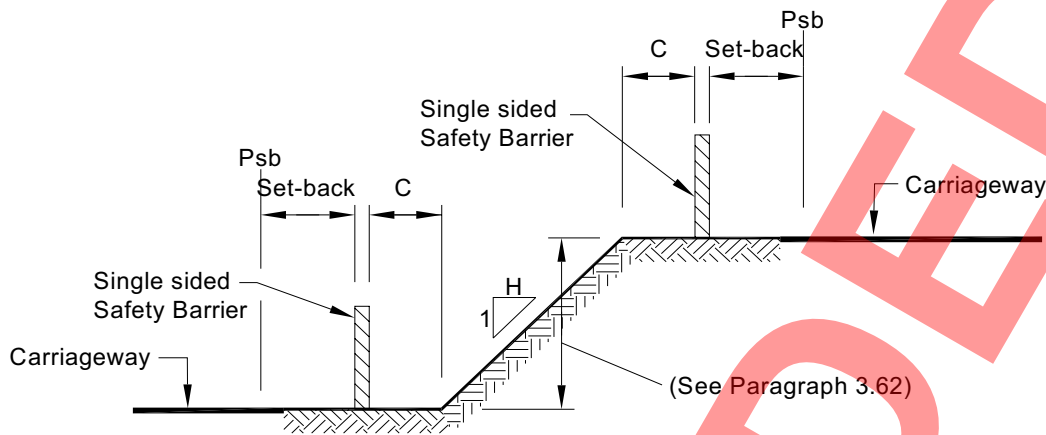


Figure 3-2(a). Height difference in carriageway greater than 200mm and slopes greater than 1 in 20

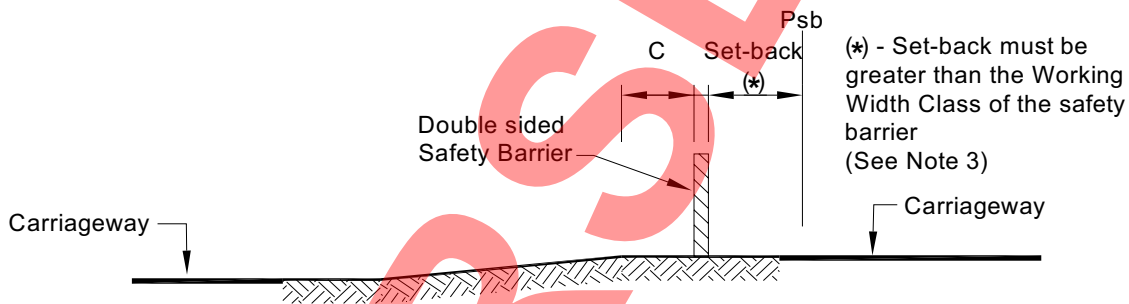


Figure 3-2(b). For slopes not greater than 1 in 20

**Notes:**

1. P<sub>sb</sub> = point from which set-back is measured (see TD 27).
2. The following conditions apply
  - a) Where the level difference across the central reserve is less than 200mm and the slope (1 in H) is shallower than 1 in 20, the dimension C may be less than the Working Width of the safety barrier.
  - b) Where the slope (1 in H) is shallower than or equal to 1 in 3, the dimension C may be less than the Working Width Class of the safety barrier, but not less than 600 mm.
  - c) Where the slope (1 in H) is steeper than 1 in 3 but shallower than or equal to 1 in 2, the dimension C must not be less than the greater of 0.75 times the Working Width Class of the safety barrier and 600 mm.
  - d) Where the slope (1 in H) is steeper than 1 in 2, the dimension C must not be less than the greater of the Working Width Class of the safety barrier and 600 mm.
  - e) On embankments and sidelong ground where the proximity of the safety barrier to the top of the slope and / or the ground conditions are likely to affect the integrity of the barrier, the advice of a Geotechnical Engineer must be sought and in-situ tests undertaken to verify the integrity of the barrier and its foundation. The advice and results of tests must be recorded.
3. General
  - a) The restrictions on dimension C are to ensure that (i) in cuttings, the barrier will perform satisfactorily and will not be affected by the slope behind it, and (ii) on embankments and sidelong ground, the ground is sufficiently strong to resist the forces that an errant vehicle and safety barrier may give rise to and also, when deflecting during a collision, that an errant vehicle is not adversely affected by the slope.
  - b) Refer to Figure 3-4 and Paragraphs 3.21 to 3.25 for details of Set-back requirements

**Figure 3-2 Minimum Distances of Safety Barrier from the Top and Toe of Slopes in Central Reserves where Safety Barrier is Required for Other Reasons**

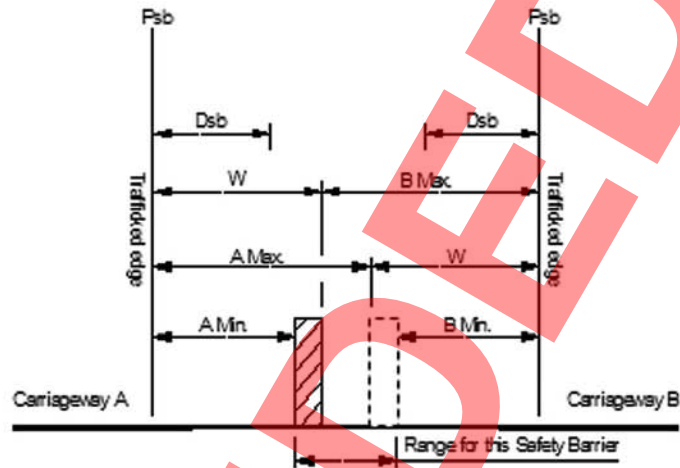


Figure 3-3(a). Range of Positions with High Value of Working Width Class (e.g. W6).

**Key:**

- Dsb = Desirable min set-back from TD 27
- W = Working Width Class
- W max = Max barrier Working Width Class that can be provided
- A = Set-back to Carriageway A
- B = Set-back to Carriageway B

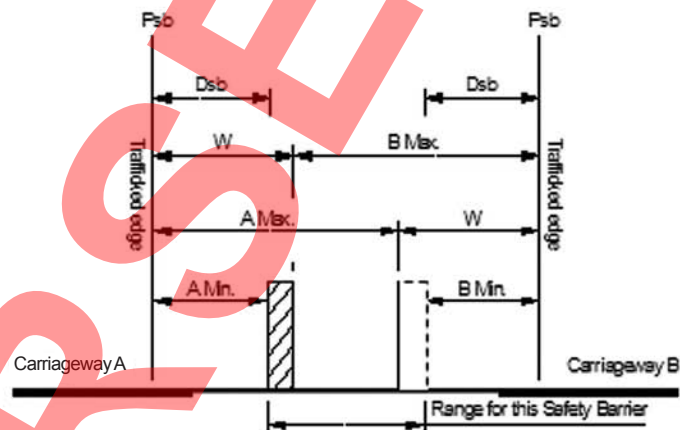


Figure 3-3(b). Range of Positions with Low Value of Working Width Class (e.g. W4).

**Key: (continued)**

- A (B) max = Max possible set-back to Carriageway A (B) with the proposed Working Width Class of Barrier
- A (B) min = Min possible set-back to Carriageway A (B) with the proposed Working Width Class of Barrier

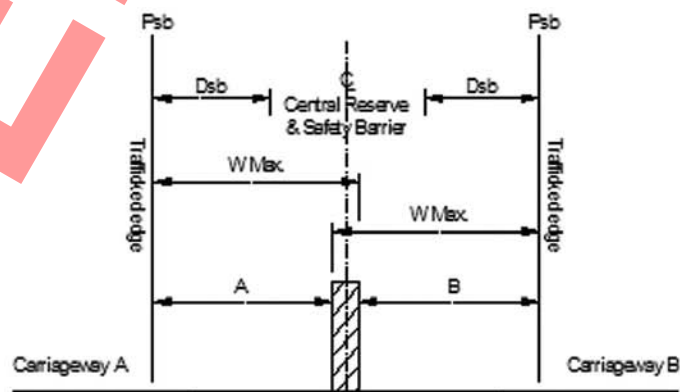


Figure 3-3(c). Maximum Working Width Class Achievable with Safety Barrier Located Centrally in Central Reserve.

Figure 3-3 Central Reserve: Ranges of Positions for Double Sided Safety Barrier

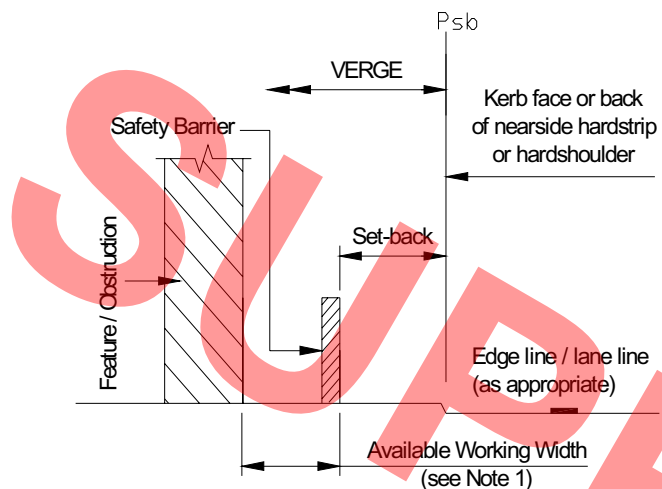


Figure 3-4 (a). Safety Barrier at Verge

Notes:

1. The Working Width Class shall not be greater than that which can be wholly contained within the available Working Width.
2.  $P_{sb}$  = Point from which set-back is measured. See Figure 3-4 and TD 27 [DMRB 6.1.2].
3. See Paragraphs 3.21 to 3.25 for details of Set-back requirements.

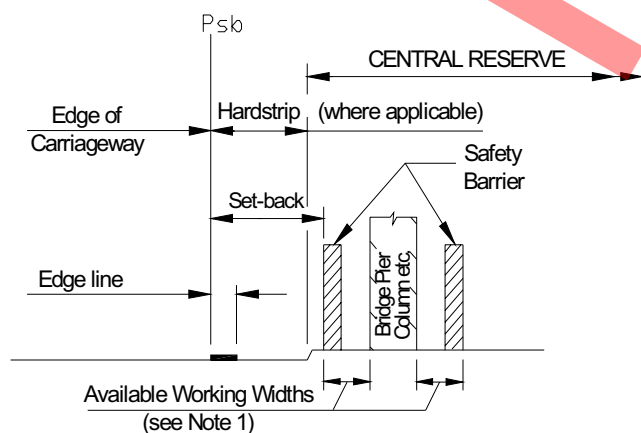


Figure 3-4 (b). Safety Barrier at Central Reserve (with Offside Edge Line)

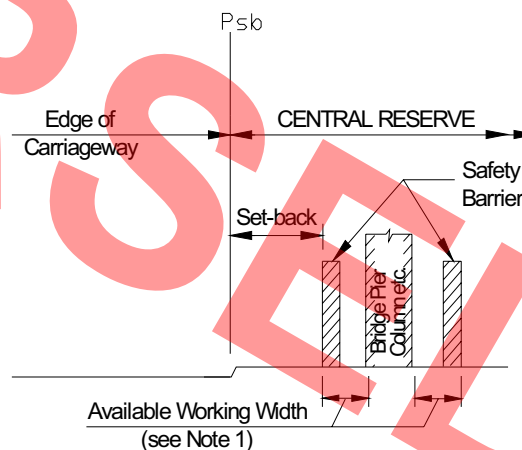
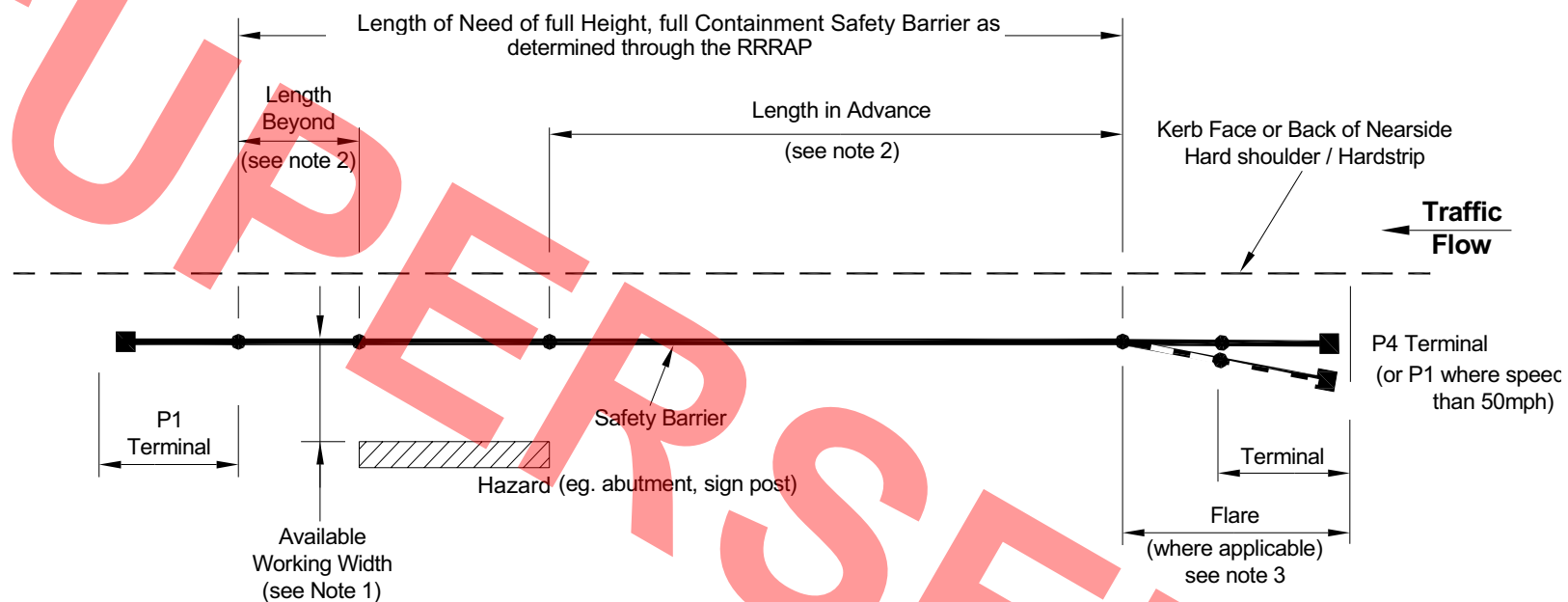


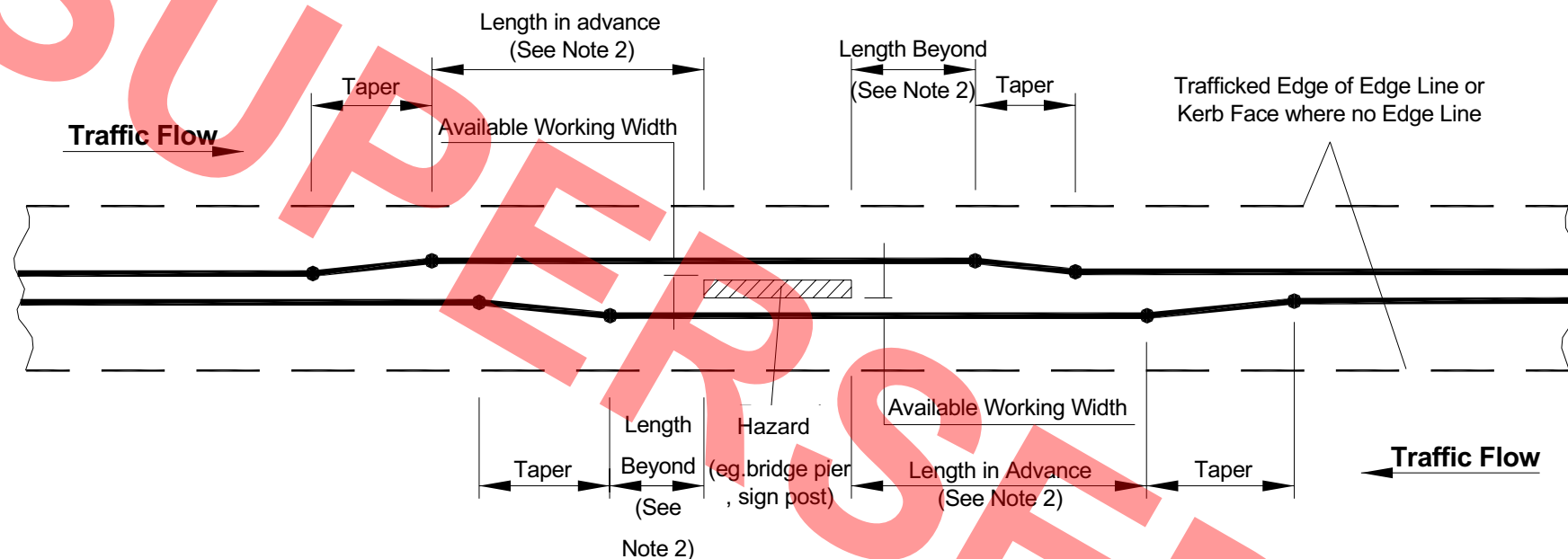
Figure 3-4 (c). Safety Barrier at Central Reserve (with no Offside Edge Line)

Figure 3-4 Set-back and Working Widths Adjacent to Hazards

**Notes:**

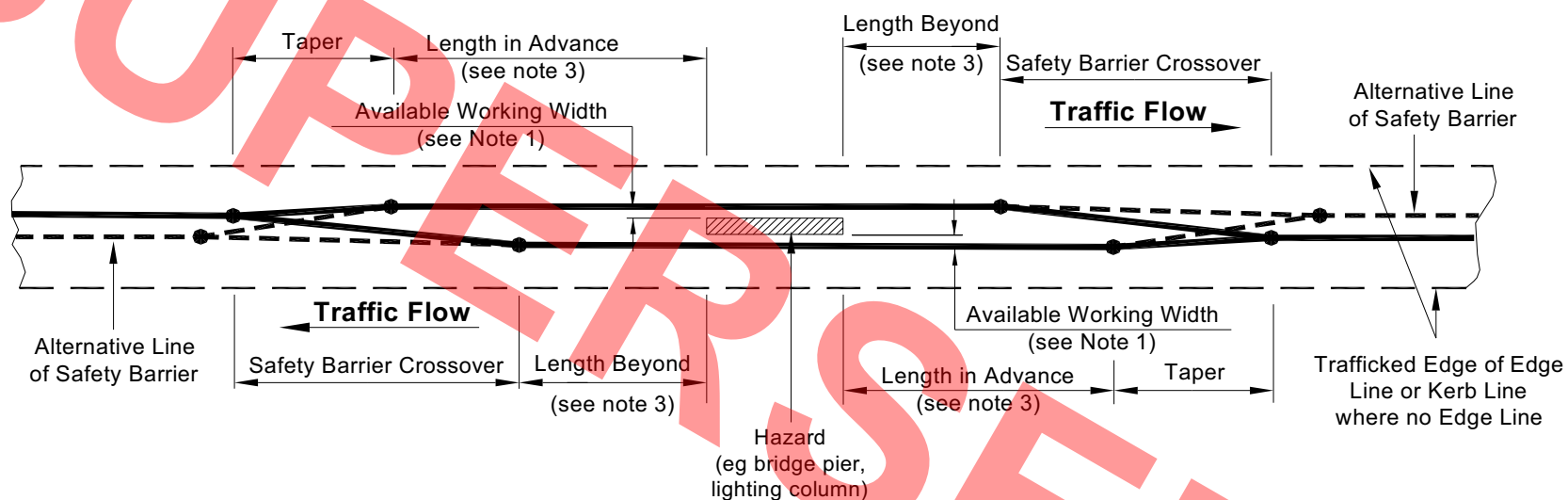
1. At hazards (e.g. structures, sign post, etc) the Working Width Class shall not be greater than that which can be wholly contained within the available Working Width.
2. Refer to Paragraphs 3.26 to 3.29 and Table 3-1.
3. Flare only provided where required by Manufacturer's system, e.g. to maintain set-back to terminal.
4. See Figure 3-4 and Paragraphs 3.21 to 3.23 for details of Set-back requirements.

Figure 3-5 Verge Safety Barrier Layout Adjacent to Hazards

**Notes:**

1. At hazards (e.g. structures, etc) the Working Width Class shall not be greater than that which can be wholly contained within the available Working Width.
2. Refer to Paragraphs 3.26 to 3.29 and Table 3-1.
3. See Figure 3-4 and Paragraphs 3.21 to 3.25 for details of Set-back requirements.
4. See Figure 3-12 for taper length requirements.

Figure 3-6 Central Reserve Safety Barriers (Single Sided) Layout Adjacent to Hazards

**Notes:**

1. At hazards (e.g. structures, etc) the Working Width Class shall not be greater than that which can be wholly contained within the available Working Width.
2. Where there is a single Double Sided Safety Barrier, the Set-back to either carriageway must not be less than the Working Width Class minus the actual width of the safety barrier, see Figure 3-3.
3. Refer to Paragraphs 3.26 to 3.29 and Table 3-1.
4. See Figure 3-4 and Paragraphs 3.21 to 3.23 for details of Set-back requirements.
5. See Figure 3-12 for taper length requirements.

Figure 3-7 Central Reserve Safety Barrier (Double Sided) Layout Adjacent to Hazards

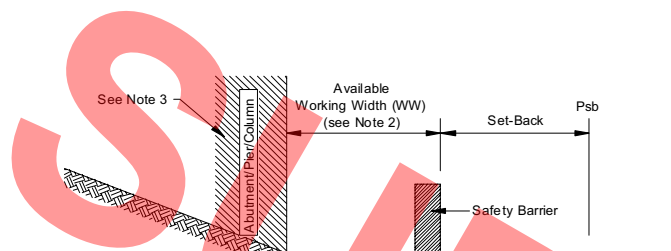


Figure 3-8 (a)

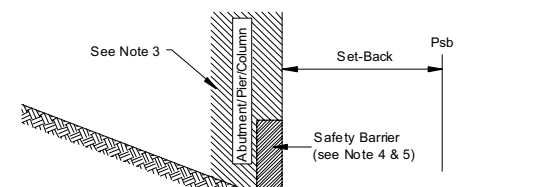


Figure 3-8 (d)

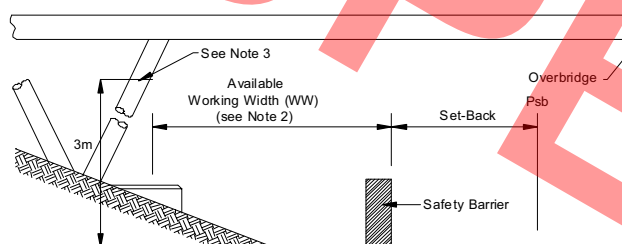


Figure 3-8 (b)

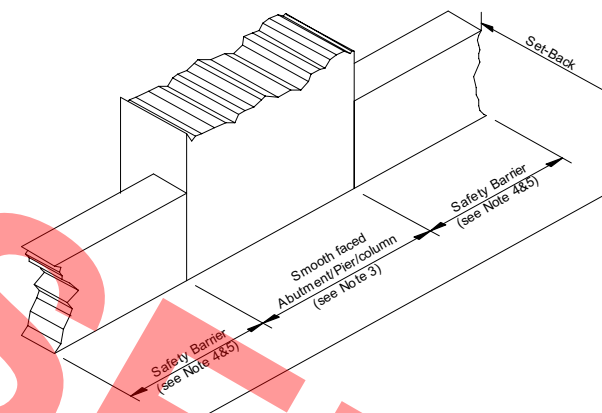


Figure 3-8 (e)

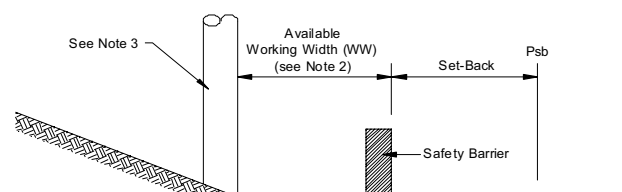
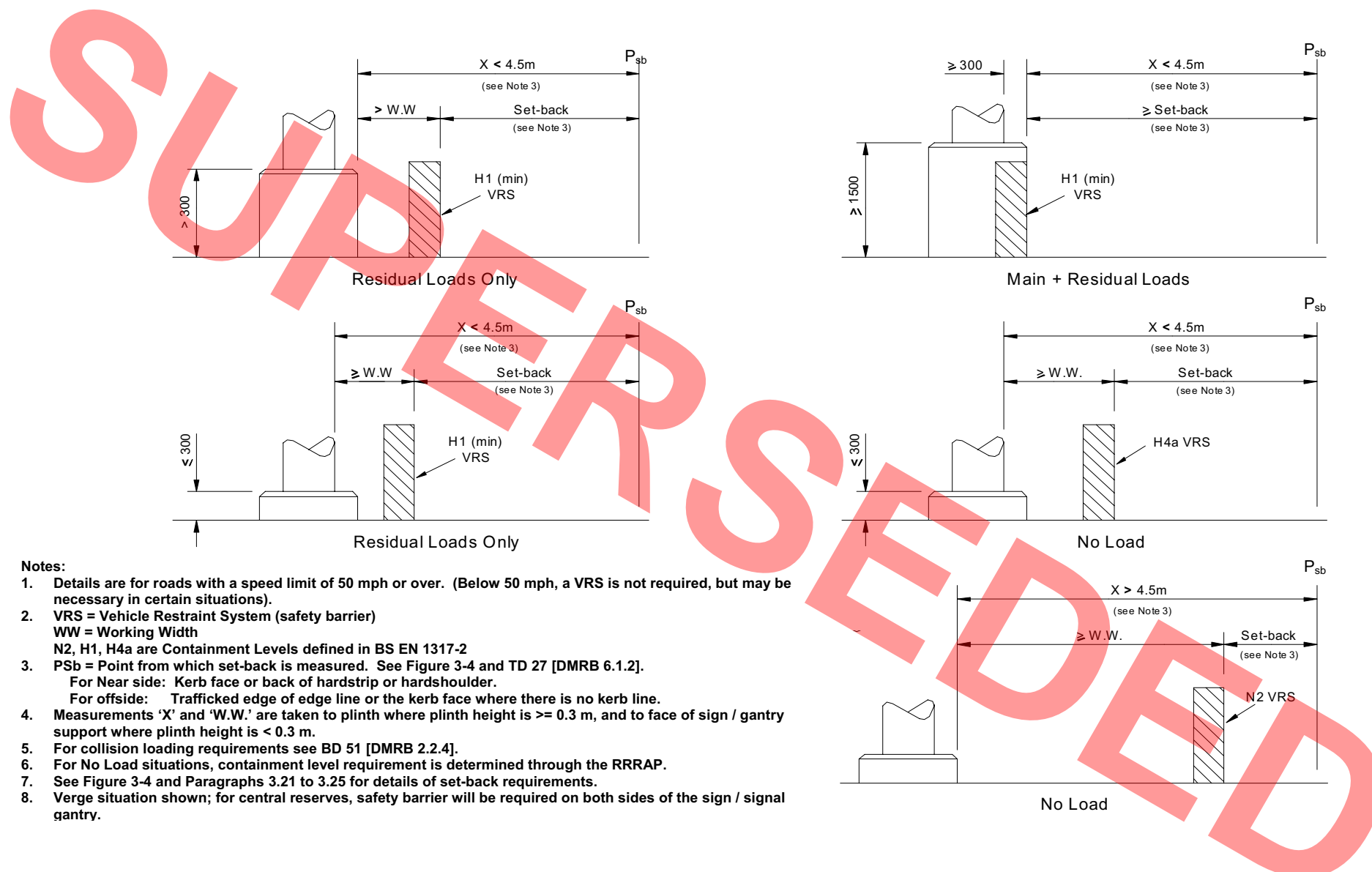


Figure 3-8 (c)

**Notes:**

1. **Psb = Point from which set-back is measured. See Figure 3-4 and TD 27 [DMRB 6.1.2].**
2. **At obstructions (e.g. structures, gantries, columns, etc) the Working Width Class shall not be greater than that which can be wholly contained within the available Working Width.**
3. **For collision loading requirements see BD 60 [DMRB 1.3.5].**
4. **Deformable safety barriers must be connected to an abutment / pier by a suitable transition.**
5. **This method of interface between supports and safety barrier is not to be used without prior agreement with the Overseeing Organisation.**
6. **Refer to Paragraphs 1.49 to 1.52 and 3.10 for guidance on Working Width and vehicle overhang and to Paragraphs 3.102 and 3.103 for guidance on location of safety barrier in relation to structures such as abutments.**

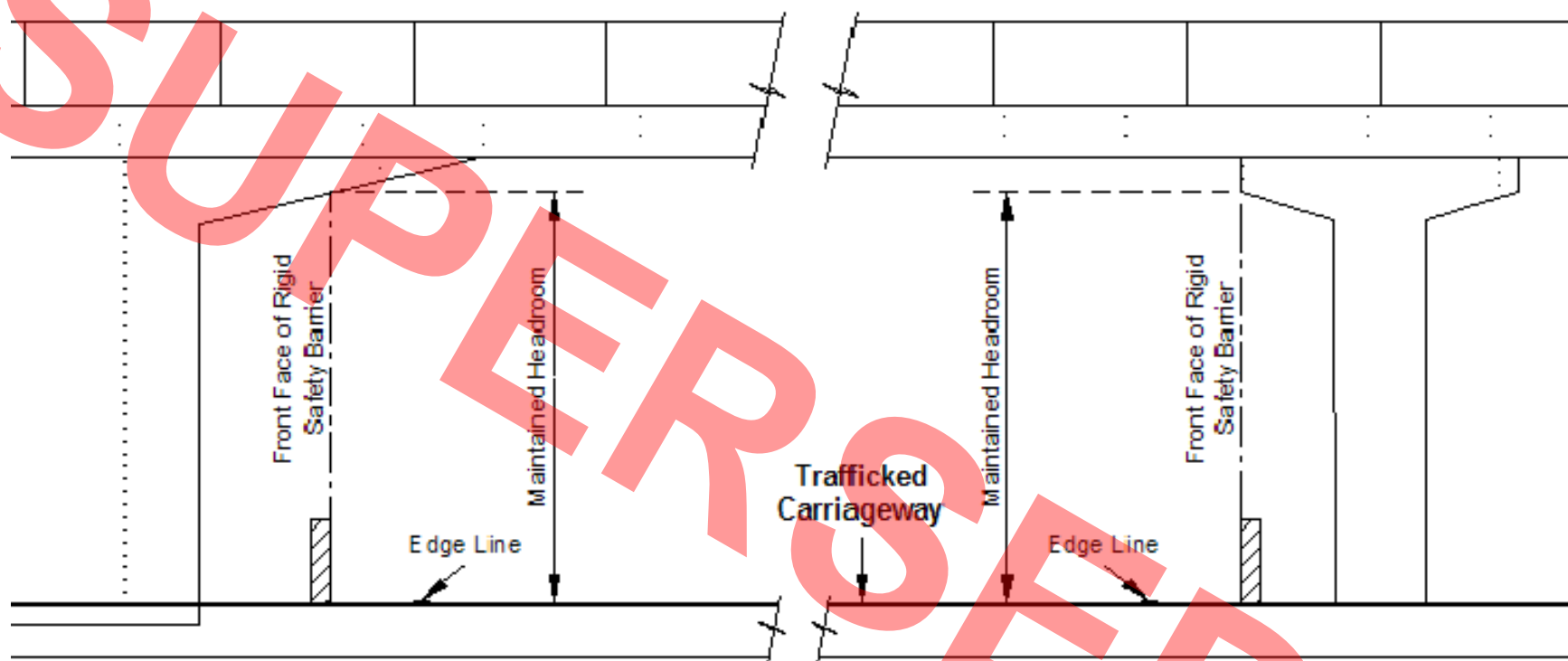
Figure 3-8 Provision of Safety Barriers at Structural Support in Verges



**Notes:**

1. Details are for roads with a speed limit of 50 mph or over. (Below 50 mph, a VRS is not required, but may be necessary in certain situations).
2. VRS = Vehicle Restraint System (safety barrier)  
WW = Working Width
3. N2, H1, H4a are Containment Levels defined in BS EN 1317-2  
PSb = Point from which set-back is measured. See Figure 3-4 and TD 27 [DMRB 6.1.2].  
For Near side: Kerb face or back of hardstrip or hardshoulder.  
For offside: Trafficked edge of edge line or the kerb face where there is no kerb line.
4. Measurements 'X' and 'W.W.' are taken to plinth where plinth height is  $\geq 0.3$  m, and to face of sign / gantry support where plinth height is  $< 0.3$  m.
5. For collision loading requirements see BD 51 [DMRB 2.2.4].
6. For No Load situations, containment level requirement is determined through the RRRAP.
7. See Figure 3-4 and Paragraphs 3.21 to 3.25 for details of set-back requirements.
8. Verge situation shown; for central reserves, safety barrier will be required on both sides of the sign / signal gantry.

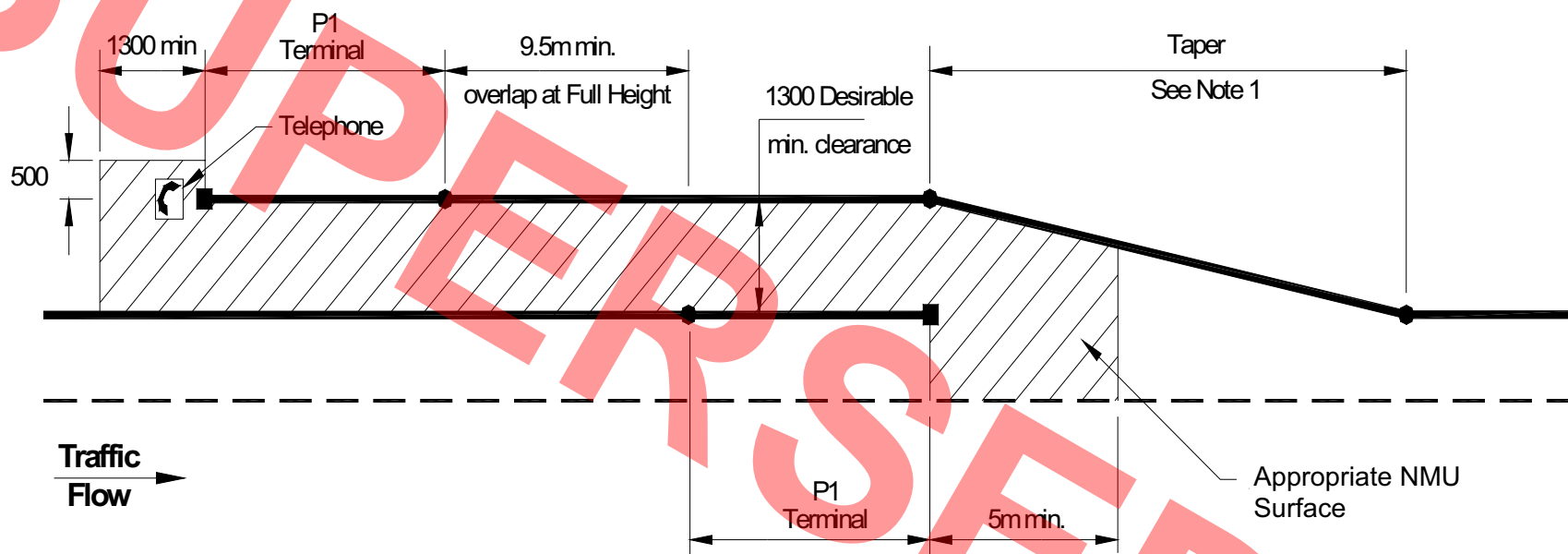
**Figure 3-9 Requirements for Protection of Sign/Signal Gantries from Collision Loads**



**Notes:**

1. See Paragraphs 1.49 to 1.52 and 3.10 regarding overhang of vehicle over rigid safety barrier.
2. See also Figures 3-8 and 3-9.

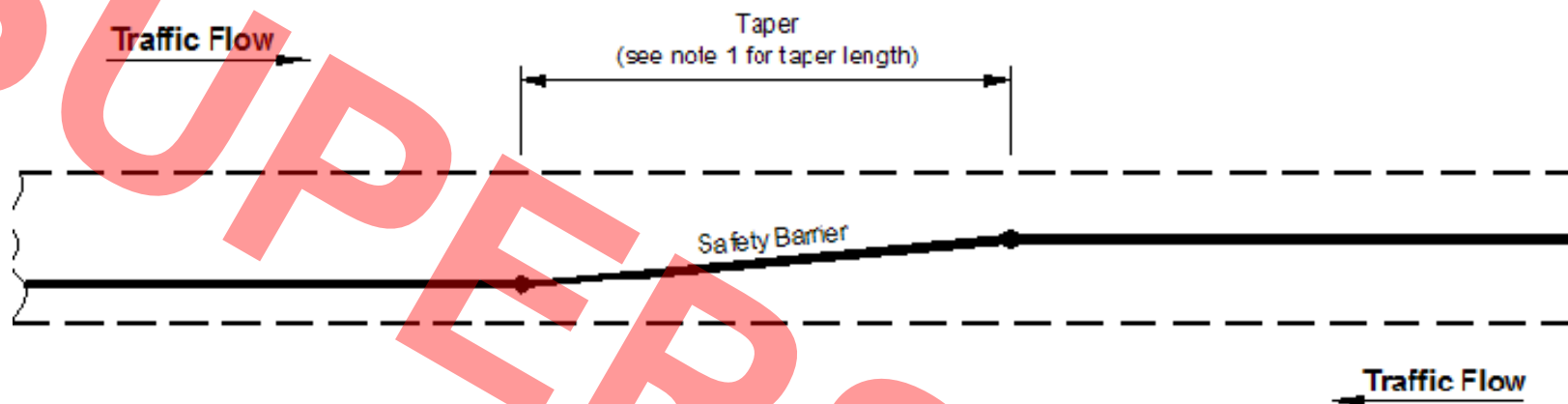
Figure 3-10 Provision of Rigid Safety Barriers at Restricted Headroom



**Notes:**

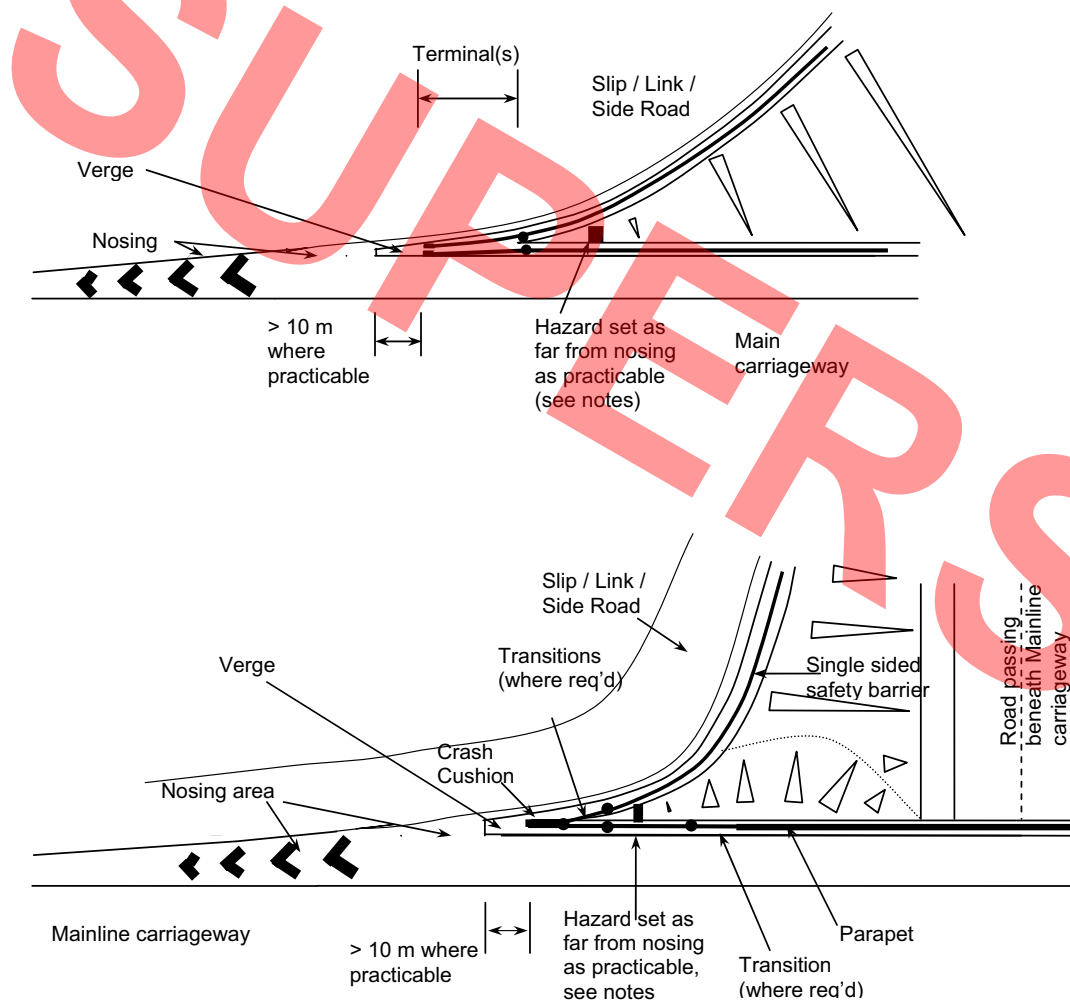
1. Refer to Figure 3-12 for Taper requirements.
2. Emergency telephones do not require VRS protection. This drawing illustrates the situation where a VRS is required for other reasons.

Figure 3-11 Accommodating Emergency Telephone at Verge Safety Barrier

**Notes:**

1. Changes of horizontal alignment to take place over taper length. Length of taper to suit rate of change in set-back.  
Rate of change of set-back not to exceed 1 in 16 for deformable safety barriers or 1 in 20 for rigid safety barriers.  
For changes in set-back less than 300 mm, length of taper to be 32 times the difference in the set-back with start and end transition curves.  
The requirements of the particular manufacturer must be verified and, where necessary, the taper length increased.
2. On central reserves, where there is a single Double Sided safety barrier, the set-backs must not be less than the Working Width Class of the safety barrier minus the actual width of the safety barrier. See Figure 3-3.
3. See Figures 3-1, 3-2 and 3-4 and Paragraphs 3.21 to 3.25.

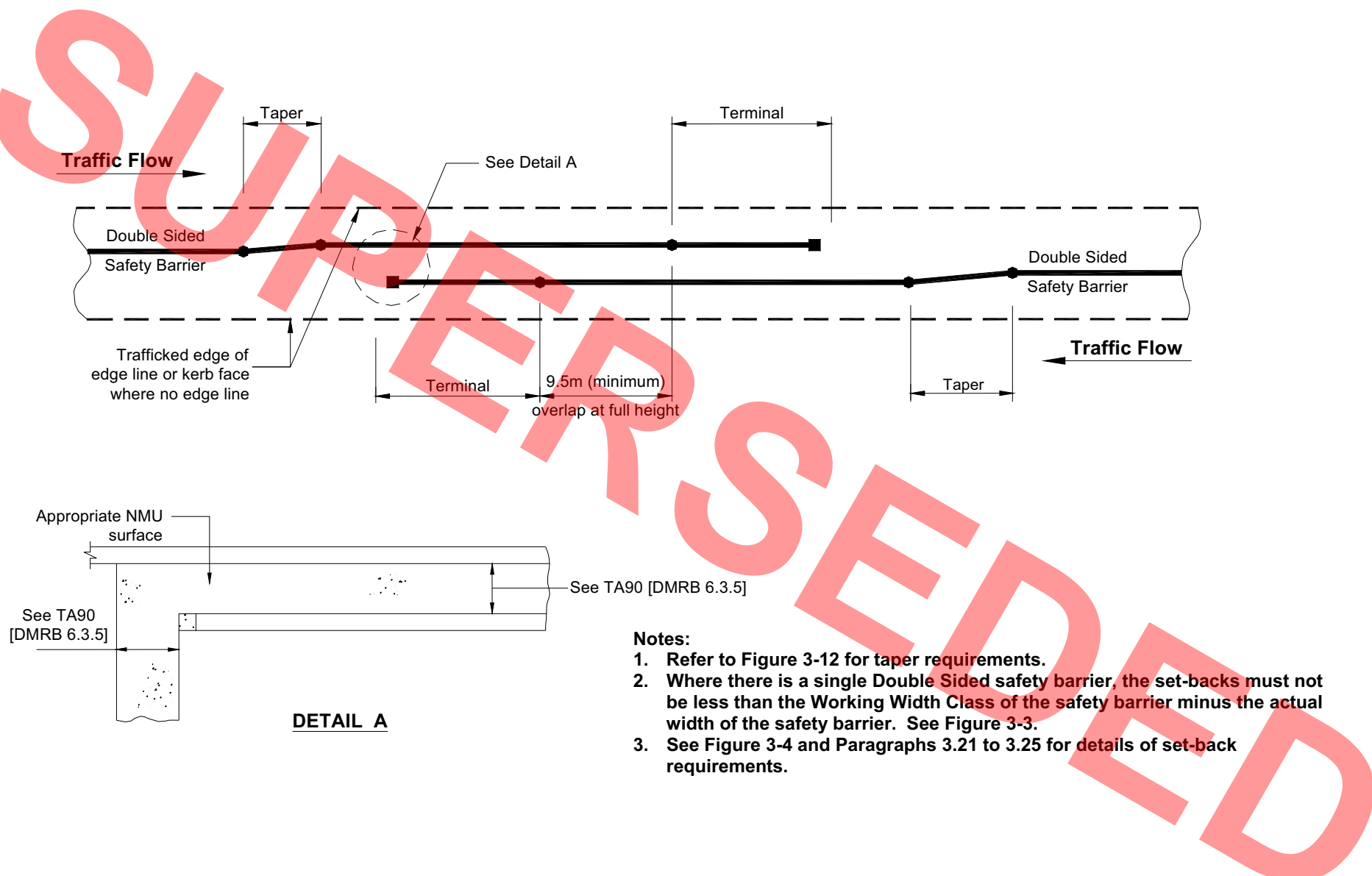
Figure 3-12 Taper Lengths at Changes in Horizontal Alignment of Verge and Central Reserve Safety Barrier



## Notes:

- 1) If feature has to be placed in Nosing area, consideration should be given to:
  - a) Can feature be made passively safe?
  - b) Can feature be moved/relocated further from Nosing, thereby decreasing risk of it being hit, whilst still fulfilling its function?
  - c) Is safety barrier required to nearside of Mainline and to offside of Slip/Link/Side road to protect the Feature and or to protect other hazards, e.g. tight bend, slope, lighting columns, etc. The RRRAP should be used to aid determination of requirements.
  - d) Can Feature be placed sufficiently far from the terminal(s) and are they of a type whereby an errant vehicle hitting them would not be guided into the Feature that the safety barrier is intended to protect?
  - e) Provision of a crash cushion, especially where space is limited and feature cannot be located to satisfy (a) to (d) above, see Chapter 7.

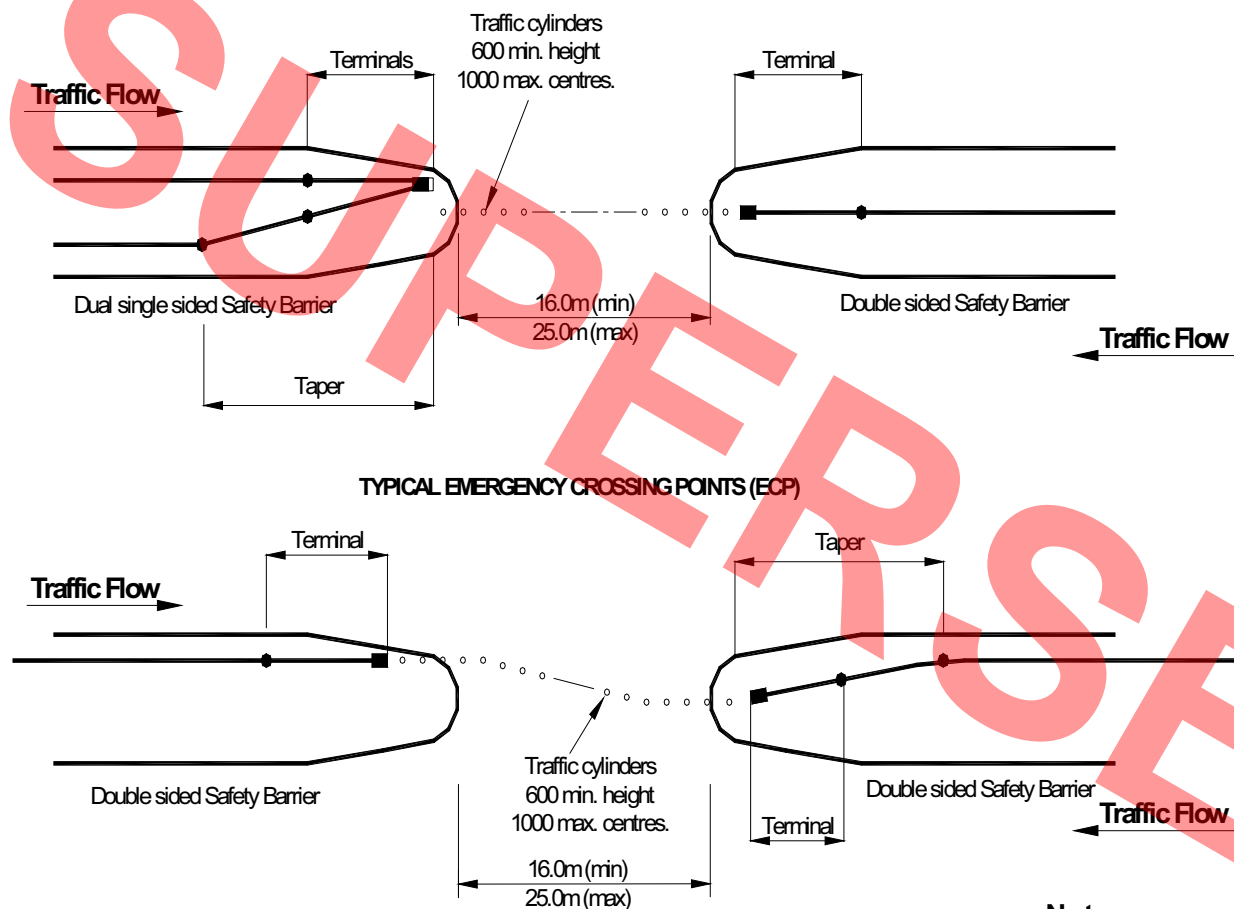
Figure 3-13 Safety Barrier Layout and Factors to Consider at Nosings



**Notes:**

1. Refer to Figure 3-12 for taper requirements.
2. Where there is a single Double Sided safety barrier, the set-backs must not be less than the Working Width Class of the safety barrier minus the actual width of the safety barrier. See Figure 3-3.
3. See Figure 3-4 and Paragraphs 3.21 to 3.25 for details of set-back requirements.

Figure 3-14 Central Reserve Pedestrian Crossing Point



**Notes:**

1. Refer to Figure 3-12 for Taper requirements.
2. Refer to Paragraphs 3.64 and 3.65
3. It may not be possible to use P4 terminals in these situations. The manufacturer should be consulted.

Figure 3-15 Safety Barrier at “Open” Emergency Crossing Points

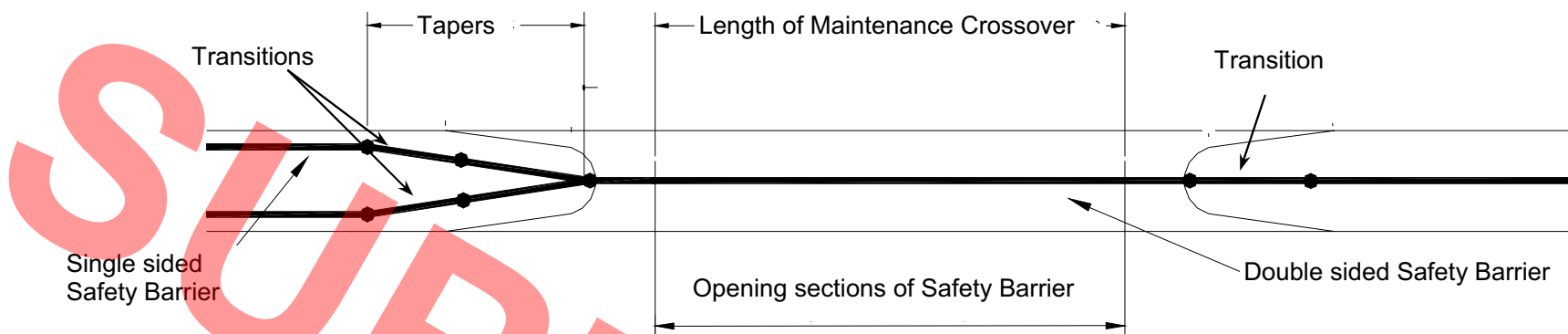


Figure 3-16 (a). Maintenance Crossover in Normal "Closed" Position.

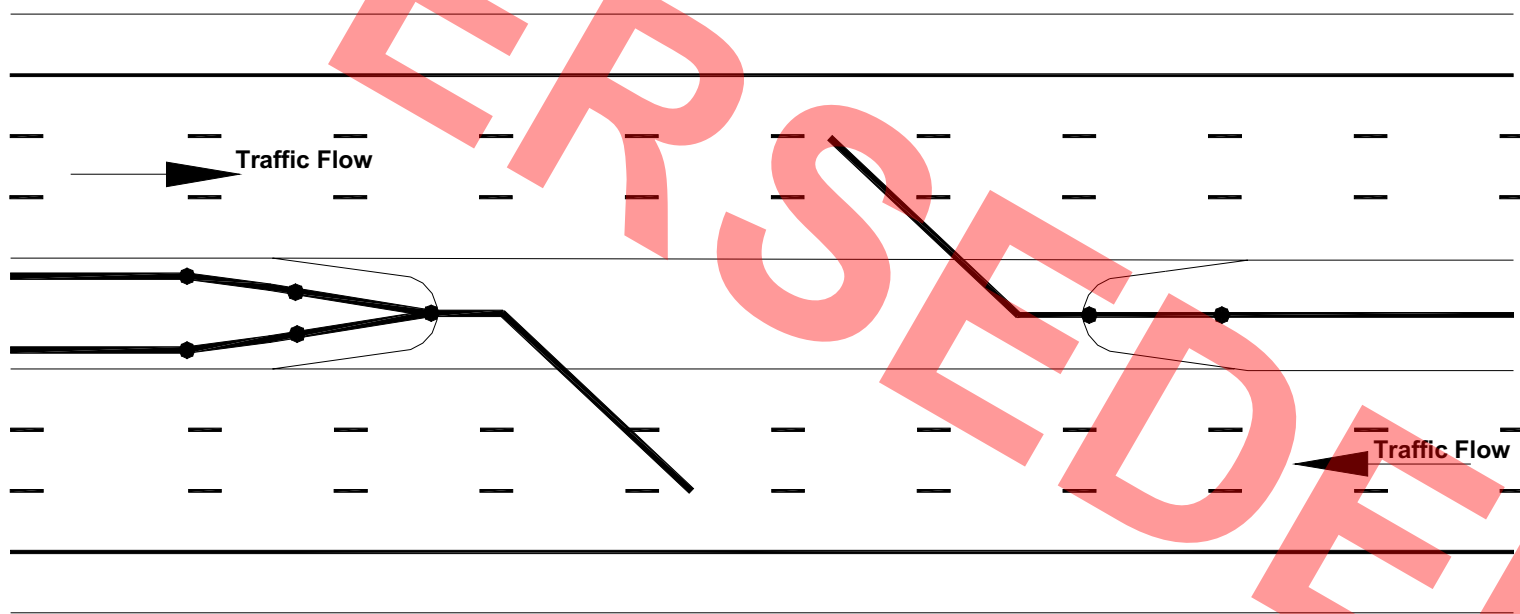
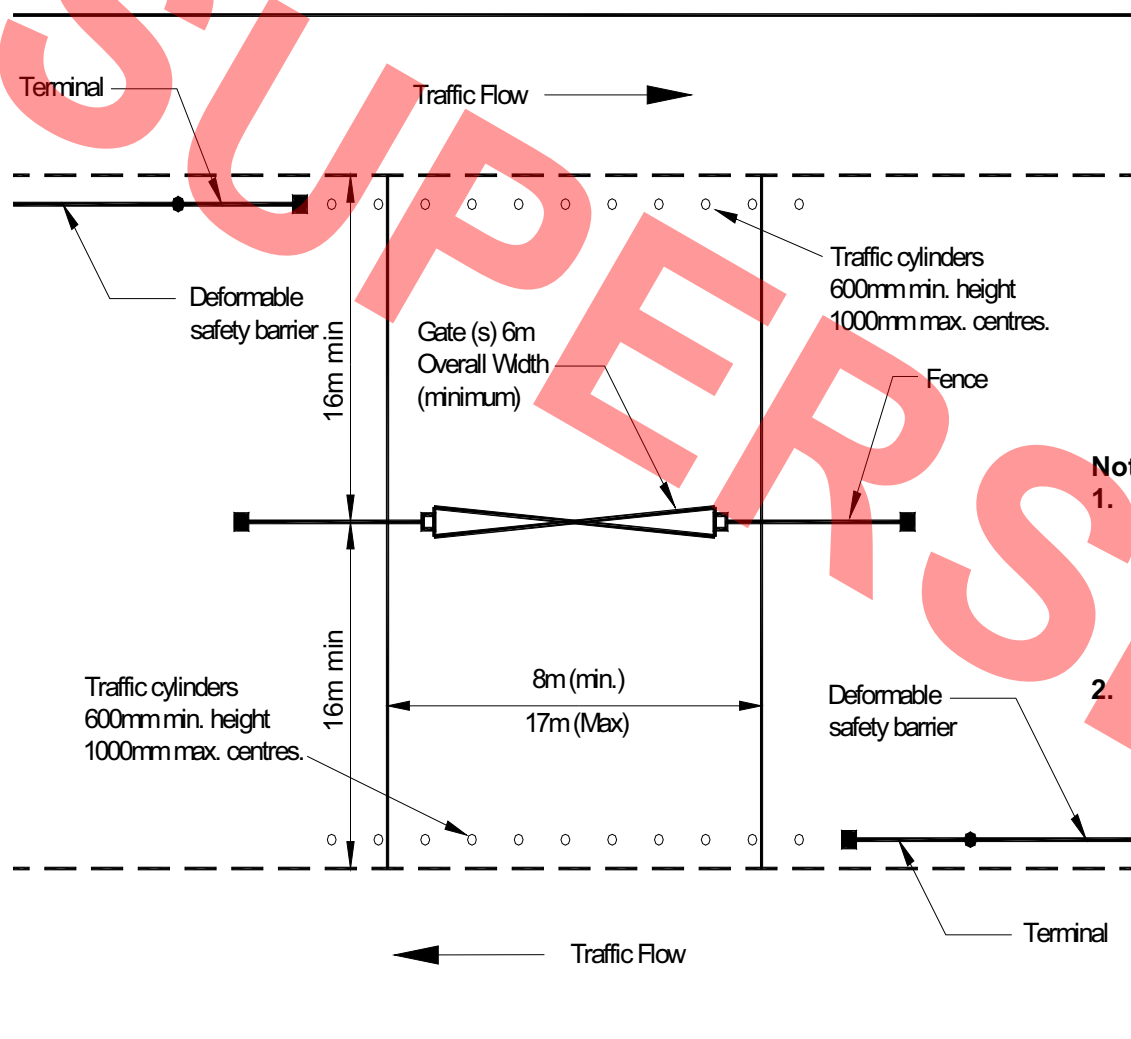


Figure 3-16 (b). Maintenance Crossover in Temporary "Open" Position During Maintenance Contraflow Periods.

**Notes**

- 1. Refer to paragraphs 3-78 & 3-79 and 3-112, 3-118 to 3.122.

Figure 3-16 Central Reserve Maintenance Crossover at Tunnels



**Notes:**

1. Dimension of 16m for minimum half width of central reserve shown. But width should be checked to ensure that it is adequate to accommodate the maximum length of vehicle plus attached equipment to use the Winter Maintenance Crossing point.
2. Refer to Paragraphs 3.88 to 3.90.

Figure 3-17 Example of Winter Maintenance Crossing

## 4. CRITERIA FOR THE PROVISION OF VEHICLE PARAPETS

### Performance Class Requirements

#### General

- 4.1 All vehicle parapets installed must be compliant with the Test Acceptance Criteria requirements of BS EN 1317-2 and the following criteria.
- 4.2 The Design Organisation must specify the required Performance Class for each parapet installation in terms of Containment Level, Working Width Class and Impact Severity Level (ISL).
- 4.3 The Design Organisation must identify any special requirements with regard to the provision of vehicle parapets which may affect the choice of System by the Contractor.

#### Containment Levels

- 4.4 The Containment Levels required for vehicle parapets are:
- i) **On roads with a speed limit of 50 mph or more:**
    - a) Normal Containment Level = N2 (*Formerly P1, P2{113} & P5 types*)
    - b) Higher Containment Level = H2
    - c) Very High Containment Level = H4a (*Formerly P6 Type*)
  - ii) **On roads with a speed limit of less than 50 mph:**
    - a) Normal Containment Level = N1 (*Formerly P2{80} Type*)
    - b) Normal Containment Level = N2 (*Formerly P1, P2{113} & P5 Types*)
    - c) Higher Containment Level = H2
    - d) Very High Containment Level = H4a (*Formerly P6 Type*)
- 4.5 The lowest Containment Levels given in Paragraph 4.4 must be provided on road bridges and structures and on bridges and structures over, or adjacent to, roads unless the Road Restraint Risk Assessment Process (RRRAP) or the text below shows that a higher containment level must be provided.
- 4.6 Other than in Northern Ireland, on new bridges and structures (other than accommodation bridges) carrying a road over, or adjacent to, a railway, Very High Containment Level (H4a) vehicle parapets must be provided regardless of the road class. Where an existing parapet has to be replaced on existing bridges and structures (other than accommodation bridges) carrying a road over, or adjacent to, a railway, the Containment Level must be the highest practicable Containment Level that can be achieved without undue cost, but must not be less than Normal Containment Level N2. An acceptable cost for provision of the required Containment Level must be based on a cost benefit analysis, the criteria for which must be agreed by the Overseeing Organisation and the Railway Authority.

4.7 In Northern Ireland and for accommodation bridges carrying a road over, or adjacent to, a railway, the minimum Containment Level for vehicle parapets is Normal Containment Level (N2). Where a higher Containment Level is derived from the RRRAP, the level of provision must be confirmed with the Overseeing Organisation and the Railway Authority.

4.8 On a new bridge or structure (including accommodation bridge) that is carrying a road, that is not over, or adjacent to, a railway, the minimum Containment Level must be that derived from the RRRAP that gives a 'broadly acceptable' level of risk.

4.9 On an existing bridge or structure (including accommodation bridge) that is carrying a road that is not over, or adjacent to, a railway, the Containment Level requirements must be determined as follows:

- (i) Where the existing bridge or structure can support a parapet with a Containment Level that gives a 'broadly acceptable' level of risk as derived from the RRRAP, this level of containment must be provided.
- (ii) Where the existing bridge or structure cannot meet the requirements of (i) above, a further assessment will be required to determine the level of containment which can be achieved without strengthening.
- (iii) If the risks associated with the provision of the lower level of containment determined from the assessment in (ii) above are As Low As Reasonably Practicable (ALARP) this lower level of containment may be acceptable.
- (iv) If the risks of providing the lower level of containment do not satisfy the ALARP principle, then strengthening of the bridge or structure will be required so as to allow the provision of a Containment Level, which would satisfy the requirements derived from the RRRAP. If such strengthening is impracticable or cost prohibitive, strengthening to provide a Containment Level which would satisfy the ALARP requirements would be acceptable.
- (v) Any proposal to provide a Containment Level that does not produce a 'broadly acceptable' level of risk as derived from the RRRAP must be supported by a Departure from Standards.

4.10 The Design Organisation must use the RRRAP to determine whether the above minimum requirements are sufficient in the particular circumstances being examined and to record the proposed level of containment and length of need.

#### Impact Severity Levels

4.11 The ISL for vehicle parapets must not normally exceed Class B as stipulated in BS EN 1317-2.

4.12 At specific locations where the containment of an errant vehicle (such as a Large Goods Vehicle) is the prime consideration, or where there is limited space available, a Vehicle Restraint System (VRS) may need to be installed with an ISL greater than Class B. The use of VRS with an ISL greater than Class B must be with the agreement of the Overseeing Organisation and justified by the RRRAP. Where an ISL greater than Class B is to be used, the following limits shall apply to the Index Values:  $ASI \leq 1.9$  and  $THIV \leq 33$  km/h.

#### Working Width Classes

4.13 The Working Width Class for each vehicle parapet installation must be the same as, or numerically less than, that specified by the Design Organisation.

4.14 The Working Width Class for vehicle parapets must not be numerically greater than specified below:

- (i) Normal Containment Levels (N1 & N2) – W4
- (ii) Higher Containment Levels (H1 to H3) – W4
- (iii) Very High Containment Level (H4a) – W5

4.15 Ideally, the parapet should be located so that, if it is impacted, there will be no gap arising between the edge of the bridge deck and the front face of the parapet that will affect the performance of the parapet. This must be demonstrated by information from the parapet manufacturer.

## General Requirements

### General

4.16 Parapets on the road network are intended to contain errant vehicles and/or protect pedestrians. In addition, they may be required to protect the area below. In special circumstances they may be required to have a solid face. Although this Chapter of the Standard applies essentially to the design of vehicle parapets on bridges, the use of the document may be extended to parapets for other structures, e.g. at the top of retaining walls, culverts, etc.

4.17 Vehicle parapets must be provided at locations as described below and where identified through the RRRAP.

4.18 Vehicle parapets for use on road bridges and bridges and structures over or adjacent to roads may be of metal, reinforced concrete, combined metal and reinforced concrete, or masonry. Masonry vehicle parapets must not be used on road bridges and structures over or adjacent to roads except where agreed by the Overseeing Organisation. When it is necessary to harmonise with local conditions, reinforced concrete vehicle parapets may be faced in masonry or brickwork provided that the facing is securely fixed to the concrete core. Facing must only be provided after consultation with the responsible authorities and with the prior agreement by the Overseeing Organisation.

4.19 The aesthetic effects of the vehicle parapet construction including its details must be considered at the initial stage of the design of the structure. New and innovative designs must be referred to the Overseeing Organisation (See Chapter 5 of **BA 41 [DMRB 1.3.11]**).

4.20 Where a wide verge is carried over a bridge or structure, the VRS may be continued across it on its conventional alignment, but a separate pedestrian parapet complying with BS 7818 must be provided additionally on the bridge or structure's edge. There needs to be sufficient width to provide the full Working Width between the VRS and the edge protection together with the set-back required in **TD 27 [DMRB 6.2.1]**. It will be necessary to agree such an arrangement with the maintenance authority and the emergency services. The requirements of pedestrians and other users need to be considered, particularly regarding the provision of footway widths and the protection from injury by the VRS. This arrangement should not be used where there is likely to be equestrian traffic using the verge.

### Parapets on Historic Monuments and Bridges, etc.

4.21 Where parapets have to be replaced or new parapets have to be provided on bridges or other structures that are historic monuments or listed structures, they must be treated in sympathy with the environment. These parapets will be subject to local planning laws and the requirements of the national planning authorities. As they are unique, they fall outside the testing requirements of BS EN 1317 which applies to products, i.e. production line items. Such parapets will have to be designed from first principles to provide the particular Performance Class requirements

required. Their form and design must be agreed with the Overseeing Organisation, Technical Approval Authority and the appropriate planning authority and will be subject to a Departure from Standards.

4.22 Guidance on the appearance of parapets is given in the Overseeing Organisation's documents 'The Appearance of Bridges and Other Highway Structures', 'The Design and Appearance of Bridges', (BA 41) and TRL's Highways Report HR5 'Improved Appearance of Bridge Parapets'.

### Height of Parapets

4.23 The height of vehicle parapets must be measured above the adjoining paved surface and must not be less than the following:

- 1000 mm – For vehicle parapets except as below
- 1250 mm – For all bridges and structures over railways carrying motorways, or roads to motorway standards, from which pedestrians, animals, cycles and vehicles drawn by animals are excluded by order
- 1500 mm – For all other bridges and structures over railways, except as below
- 1400 mm – For cycleways immediately adjacent to the vehicle parapet
- 1500 mm – For accommodation bridges
- 1500 mm – For very high containment level applications
- 1800 mm – For bridleways or equestrian usage immediately adjacent to the vehicle parapet
- 1800 mm – For automated railways and where there is a known vandalism problem over railways

4.24 Special conditions at particular sites may require higher vehicle parapets; these cases should be identified in the RRRAP and the required provision agreed with the Overseeing Organisation. See also Paragraph 4.38 relating to height of parapets over railways.

4.25 In order to discourage the stationing of vehicles with their wheels close to the vehicle parapet, a raised verge with a kerb must be provided behind the edge of the hardshoulder, hardstrip or carriageway. The dimensions of kerbs and raised verges at parapets are given in HA 83 [DMRB 4.2.4] and TD 27 [DMRB 6.1.2] respectively. The adjoining paved surface and verge must fall away from the parapet and towards the top of the kerb to prevent water and salt build up at the base of the parapet which may have a detrimental effect on the parapet or its foundation or fixings.

4.26 It is recommended that the gradient should be in the region of 1 in 20 (5%), but not more than 1 in 10 (10%) or less than 1 in 40 (2.5%) except where pedestrians are excluded from the verge when the maximum gradient may be increased to 1 in 5 (20%). At the ends of the bridge, where the road does not have a continuous kerb, the kerb and verge must slope down gradually to the level of the paved surface on the bridge approaches.

4.27 Where metal parapets are proposed, the Design Organisation should consider the need for a 50 – 100 mm plinth upstand. This upstand defines the deck edge from a drainage point of view and has benefits where pedestrians have access.

### Infilling of Parapets

4.28 It is not practical to make vehicle parapets completely unclimbable but, where pedestrians have access, infilling must be provided and the parapet should not provide toeholds.

4.29 Where metal vehicle parapets of open construction are required to provide both vehicle containment and pedestrian protection they must be fitted with infill in accordance with Chapter 8 of BS 6779-1.

4.30 Infilling will not normally be required on motorway underbridges or structures adjacent to motorways except where they cross or are adjacent to railways (refer to Paragraphs 4.39 et seq.).

4.31 Consideration should be given to the provision of mesh infilling to part height of the vehicle parapet in order to prevent loose debris, stones or snow falling to the area beneath. Any such provision must be agreed with the appropriate Overseeing Organisation.

### Provision for Divided Structures

4.32 When designing a divided structure to carry a dual carriageway, the longitudinal gap between the two bridge decks should be narrow (<100 mm) and present no danger to pedestrians or vehicles thus avoiding the need for vehicle parapets in the central reserve. If a wider gap of between 100 mm and 2 m is unavoidable, a horizontal grid or slab designed to carry HA loading must be provided. Where these provisions are impractical, vehicle parapets must be provided.

4.33 Where vehicle parapets are provided on structures other than those over railways and the gap is between 100 mm and 2 m, the gap is to be protected by a horizontal grid, slab, mesh or plate designed to carry the following nominal loads:

UDL – 0.75 kN/m<sup>2</sup>

Patch Load – 1 kN over area of 200 mm x 200 mm

The patch load must be positioned to give the most adverse effect.

4.34 If the divided structure is over a railway and the gap is between 100 mm and 2 m the gap must be infilled by a solid slab or plate designed to carry HA loading irrespective of the type of VRS.

### Masonry or Brickwork Facings

4.35 Where masonry or brickwork facing to reinforced concrete parapets is accepted by the Overseeing Organisation the following minimum criteria must be satisfied:

- (i) Materials and workmanship must be in accordance with Series 2400 [MCHW 1].
- (ii) Fixings must be spaced at not more than 450 mm horizontally and 300 mm vertically. Additionally, brick reinforcing mesh must be incorporated into the bedding joint below that containing the fixings.
- (iii) Fixings and brick reinforcing mesh must be in stainless steel and must not be placed in contact with carbon steel reinforcement.
- (iv) Stone used on the front face must normally be of the form of close jointed ashlar or generally smooth blocks. Bricks must have a reasonably smooth surface. Pointing must be near flush.

- (v) Masonry on the front face of the parapet may have an irregular surface finish subject to the maximum amplitude of the steps and undulations in the surface not exceeding 30 mm when measured with respect to a plane through the peaks. This plane must be flat for straight vehicle parapets and curved to follow the nominal vehicle parapet curvature for vehicle parapets which are curved on plan.
- (vi) Uncoursed work, where it is impractical to provide reinforcing mesh, shall only be permitted where there is a low probability of detached masonry presenting a hazard to the public. Uncoursed work shall not be permitted on the front face of the parapet.

### Stone or Precast Concrete Copings

4.36 Stone or precast concrete copings to the top of vehicle parapets must only be used with vehicle parapets of concrete construction where the permitted speed is 30 mph or less. Where they are used, the copings must be secured to the concrete backing by fixings capable of resisting at the ultimate limit state a horizontal force of 33 kN per metre of coping.

## Additional Requirements for Vehicle Parapets Over or Adjacent to Railways

### General

4.37 A safety barrier must be provided on each approach end of the vehicle parapet and on each departure end to prevent a vehicle from reaching the railway below. The length of safety barrier as stated in Chapter 3 Paragraphs 3.30 to 3.33 is the minimum to be provided and must be increased if, based on the RRRAP, it is considered that a significant risk still exists from a vehicle leaving the highway at a greater distance from the bridge and continuing to the railway.

### Height of Parapets

4.38 Where it is necessary to increase the height of a 1500 mm high parapet tested to BS EN 1317 to 1800 mm for an automated railway or where there is a vandalism problem, the additional height may be provided by the use of a suitable additional non-participating structural extension to the parapet (which is not designed to participate in containment and redirection of the vehicle, but is designed not to become detached under impact). This non-participating extension must be designed and constructed such that it is compatible with and not detrimental to the performance of the parapet system to which it is attached. Details of proposals for the non-participating extension and parapet system must be forwarded to the Overseeing Organisation for their consideration as a Departure from Standard.

### Infilling of Parapets

4.39 The requirements for infilling vehicle parapets on bridges or structures over or adjacent to railways are given in BS 6779-1 and this Chapter. Where reference is made in these documents to “where electrification is likely” this must denote electrification included within the Railway Authority’s Investment Programme current at the time when the vehicle parapet provision is being considered.

4.40 Where metal vehicle parapets of open construction are provided they must have infill for railway applications in accordance with Chapter 8 of BS 6779-1.

4.41 Toeholds on the traffic face are not prohibited where pedestrians are excluded by Statutory Order. Panelling may therefore be attached behind the horizontal members in this situation.

4.42 Metal vehicle parapets must be provided with additional solid or mesh sheeting on the outer (non-traffic) face of the parapet extending to its full height with the lower part shaped to cover the outer ledge. The outer face sheeting must deny access to the outer ledge and extend horizontally for the length of at least one panel or 2 m, whichever is the greater. It must be fitted at the ends of the vehicle parapet or on both sides of the railway tracks. In all cases the distance from the outer end of the sheeting away from the railway tracks must be at least 3 m from the outer limit of any railway tracks or any live overhead electrification equipment.

4.43 The outer face sheeting at the ends of the vehicle parapet must be extended in length for situations where the outer ledge is readily accessible from any area adjacent to the bridge.

4.44 Any other method of denying access to the outer ledge of the vehicle parapet must be subject to the agreement of the Railway Authority and the Railway Inspectorate.

## Design Requirements for Parapet and Supporting Structure

### General

4.45 The design requirements given in this Standard for vehicle parapets are based on a cantilever action from the bridge deck. Main structural members of bridges must not be designed to act as vehicle parapets.

4.46 The Design Organisation is responsible for assessing the condition of and calculating the design resistance of the concrete member supporting the parapet. The member supporting the parapet must be designed or assessed for a parapet impact loading in accordance with Departmental Standard **BD 37 [DMRB 1.3]**.

4.47 Existing structures may require strengthening to meet the loading imposed by new parapets. Where it is found to be uneconomical or undesirable, perhaps for aesthetic reasons, to strengthen an existing structure to take a parapet of the required Containment Level and Working Width, and or to strengthen the verge section of the bridge deck to take the full vehicle loading requirements, strengthening to allow provision of a suitable vehicle safety barrier at an appropriate location between the existing parapet and edge of carriageway may warrant investigation.

### Metal Parapets, Precast Concrete Panel Parapets

4.48 The anchorages and the main structure, including the plinth, must be designed to resist without damage all loads which the vehicle parapet is theoretically capable of transmitting, up to and including failure, in any mode that may be induced by vehicular impact. Where it is an integral feature of the design of the vehicle parapet, it is acceptable for the failure to occur within the attachment system (e.g. holding down bolts), but not within the anchorage, which is embedded within the supporting structure. The design of vehicle parapet attachment systems and anchorages must be such that removal and replacement of damaged sections of the vehicle parapet may be readily achieved without damage to the supporting structure. The design will need to allow for replacement of holding down bolts or sleeved threaded bar that can be withdrawn from the plinth.

4.49 The Design Organisation is required to specify the loading and anchorage requirements that the structure is capable of meeting in such a way that the Contractor may select a complying parapet product and its associated anchorages. Since the parapet system to be used may not be known at the time of preparing the design, the Design Organisation will be required to make assumptions relating to the loads applied to the supporting structure. Any limitations required to the design of the parapet, which may be imposed by these assumptions, must be made clear to the Contractor.

4.50 The parapet anchorage and attachment system, which shall form part of the parapet system supplied by the manufacturer, shall comply with the requirements of Paragraph 4.48 and any additional requirement of paragraph 4.49.

4.51 BS 5400-4 and Departmental Standards **BD 24 [DMRB 1.3.1]** and **BD 44 [DMRB 3.4.14]** as appropriate must be used to determine the design resistance of the reinforced concrete support member for concrete cone failure.

4.52 The Design Organisation must give details of any site tests, which the Contractor has to carry out, to demonstrate that the parapet anchors have been installed satisfactorily.

4.53 The Contractor may propose a parapet system that complies with the minimum Containment Level and Working Width Class requirements that imparts loads on the structure that are in excess of those that the Design Organisation has specified. In such instances, the Contractor must provide calculations that confirm that the structure is capable of resisting without damage all loads which the Contractor's chosen vehicle parapet system is theoretically capable of transmitting, in any mode that may be induced by vehicular impact.

4.54 The Design Organisation must check the adequacy of the selected anchors after the Contractor's proposals are known.

#### Reinforced Concrete Parapets

4.55 Vehicle parapets in concrete construction must be designed in accordance with BS 6779-2 as amended by Paragraph 4.56 to Paragraph 4.60 inclusive of this Standard. When designing to BS 6779-2, the Normal Level of Containment of BS 6779-2 is considered to be equivalent to BS EN 1317-2; Normal Containment (N2) and the High Containment Level of BS 6779-2 is considered to be equivalent to BS EN 1317-2; Very High Containment Level (H4a).

4.56 Reinforced concrete vehicle parapet panel walls must have a minimum thickness of 180 mm for Normal Containment Level (N2) and 325 mm at the critical design section for Very High Containment Level (H4a).

4.57 Reinforced concrete vehicle parapet panel walls must have a minimum length of 2.0 m and a maximum length of 3.5 m.

4.58  $\gamma_m$  for the reinforcement in the in-situ vehicle parapet wall must be 1.0 not 0.8 as given in Table 4 of BS 6779-2.

4.59 Vehicle parapets for Normal Containment Level (N2) must be designed for an equivalent static nominal load for a nominal bending moment of 100 kN over 1.0 m, and not 50 kN over 1.0 m as given in Table 2 of BS 6779-2.

4.60 Vehicle parapets for Normal Containment Level (N2) must be designed with shear transfer provision between adjacent panels. An equivalent static nominal load of 50 kN must be transferred between adjacent panels within the top 0.5 m of the sections.

#### Combined Metal and Concrete Parapets

4.61 There is currently no design guidance for metal and concrete parapets which was previously covered by BS 6779: Part 3. This has now been withdrawn as it does not comply with modern standards and BS EN 1317. Where such a parapet is required, it would need to be designed from first principles.

### Assessment of Existing Masonry Parapets

4.62 The containment capacity of existing vehicle parapets in reinforced or unreinforced masonry may be assessed in accordance with BS 6779-4.

### Guidance on the Design of Drilled-in Anchorages for Vehicle Parapets

4.63 The design methods in this guidance apply to the design of drilled-in mechanical interlock and bonded anchors in concrete for vehicle parapets of post and rail construction where the ultimate failure of the parapet occurs by collapse or shear of the post. However, the principles may be applied to the anchorages of vehicle parapets of other forms. Other design methods may be used but, in accordance with paragraph 4.48, the principle must be demonstrated that the anchorage and the supporting structure must not suffer damage.

4.64 It should be noted that the characteristic resistance of anchors relate to either steel or pull-out (bond) failure and are based on a series of tests conducted on single anchors rather than anchorage groups. The tested anchors are installed in either cracked or non-cracked concrete having a compressive strength of 25-35 N/mm<sup>2</sup> and so that they are unaffected by edge or overlapping cone effects.

4.65 Metal anchors, which have been installed in concrete, will fail ultimately by one of four recognised failure modes, which are:

- (i) steel failure;
- (ii) pull-out failure;
- (iii) concrete cone failure;
- (iv) concrete splitting.

4.66 The design method is based on laboratory tests which eliminated concrete cone failure and concrete splitting by inclusion of adequate reinforcement. Therefore, the characteristic resistances of anchors are related to either steel failure or pull-out failure.

4.67 The Design Organisation will have to consider the following factors in determining whether the design resistance of the proposed anchor exceeds the design actions to which the anchorage may be subjected:

- (i) concrete strength;
- (ii) whether the concrete is cracked or uncracked (based on visual inspection).

4.68 Existing structures, on which new or replacement parapets are to be installed, would have been designed to different standards, depending on the requirements current at the time of design. The Design Organisation must assess the design resistance of the reinforced concrete parapet beam with respect to concrete cone failure and concrete splitting. If the concrete member is inadequately reinforced then the Design Organisation must consider a different solution, possibly including breakout and reconstruction of the vehicle parapet support beam.

4.69 Series 400 (MCHW 1) includes a provision whereby tensile axial tests are to be conducted on nominated anchors. These tests at the serviceability limit state are intended to demonstrate that the anchors have been installed satisfactorily. They are not intended to determine the ultimate capacity of the anchors. The test load is to be the nominal load in the holding-down bolt at collapse of the parapet increased by 10%. (A method for the determination of the collapse load can be found in cl. 9.1.2.5 of BS 6779-1).

### Design Concept for Drilled-in Anchorages

4.70 Anchors are designed by the application of limit state principles, using the ultimate limit state and appropriate partial factors.

4.71 The following equation is observed:

$$F_d \leq R_d$$

Where:

$F_d$  = design actions

$R_d$  = design resistance

4.72 The design actions for different metal parapet systems are calculated using the following equation in the ultimate limit state:

$$F_d = \gamma_{fl} \times Q_k$$

Where:

$\gamma_{fl} = 1.8$  (taken from Table 7 of BS 6779-1)

$Q_k$  = nominal load transmitted at collapse of the parapet post. (A method for the determination of this load can be found in cl. 9.1.2.5 of BS 6779-1:1998).

4.73 For each anchor the following values and details are to be provided by the manufacturer:

- (i) anchorage type (bonded or mechanical interlock);
- (ii) the characteristic anchorage resistance (5% fractile),  $R_k$ ;
- (iii) effective anchorage depth,  $h_{ef}$ ;
- (iv) the mode of failure;
- (v) the appropriate partial safety factor for material  $\gamma_m$ ;
- (vi) whether the test was conducted in cracked or uncracked concrete;
- (vii) cracked concrete reduction factor,  $\psi_{ucr}$ ;
- (viii) design resistance  $R_d$ ;
- (ix) limitations on use.

4.74 The design resistance for the anchor in the ultimate limit state shall be calculated from the following equation:

$$R_d = \frac{R_k}{\gamma_m \times \psi_{ucr}}$$

Where:

$R_d$  = Characteristic anchorage resistance

$\gamma_m$  = Partial safety factor

$\psi_{ucr}$  = The factor to take account of whether the anchor is to be placed in cracked or non-cracked concrete

This factor is only applied where the failure mode is through pull-out or concrete cone and may be assumed to be 1.0 for uncracked concrete and 1.4 for cracked concrete.

4.75 The values for the partial safety factors,  $\gamma_m$  used in Paragraph 4.74 depend upon the mode of failure and are as follows:

$\gamma_{mc}$  = Partial safety factor for concrete cone failure = 1.25

$\gamma_{mp}$  = Partial safety factor for pull-out = 1.5

$\gamma_{ms}$  = Partial safety factor for steel failure =  $\frac{1.2}{f_{yk} / f_{uk}} \geq 1.4$

Where:

$f_{yk}$  = Characteristic yield strength of the steel

$f_{uk}$  = Characteristic ultimate strength of the steel

4.76 The design resistance is valid if the anchorage is to be installed in a concrete member which is adequately reinforced to resist the design actions.

4.77 Guideline for European Technical Approval of Anchors (Metal Anchors) for Use in Concrete Annex C, Design Methods for Anchorages (ETAG 001), gives guidance and a method for calculating characteristic resistance of anchorages with respect to concrete cone failure in unreinforced concrete.

## 5. CRITERIA AND GUIDANCE FOR THE PROVISION OF TERMINALS

### Performance Class Requirements

#### General

- 5.1 All terminals must conform to the requirements of DD ENV 1317-4 (or its successor standard) and the following criteria.
- 5.2 The Design Organisation must specify, in Appendix 4/1 (**MCHW 2**), the Performance Class requirements for each terminal installation in terms of Performance Class (e.g. P3 or P4), Impact Severity Level (ISL) (e.g. ISL Class A or B), the Permanent Lateral Displacement Zone (PLDZ) characteristic D.x.y (e.g. D.1.3.) and the Exit Box Class (e.g. Z1, Z2, Z3 and Z4). (See Guidance Paragraph 5.11 et seq. on the terminology).
- 5.3 The Design Organisation must identify any special requirements with regard to the provision of terminals which may affect the choice of System by the Contractor.
- 5.4 The Contractor must check and ensure with the Vehicle Restraint System (VRS) manufacturer(s) that the proposed Systems comprising safety barrier, terminals and transitions will act together effectively and meet the Performance Class criteria and other requirements specified.

#### Performance Classes

- 5.5 The Performance Class requirements for terminals are as follows.
- (i) **On roads with a speed limit of 50 mph or more:**
- (a) For terminals that face oncoming traffic, e.g. those at both ends of a VRS on a two-way single carriageway road, the minimum Performance Class must be P4. Ramped end terminals must not be used.
- (b) For terminals that do not face oncoming traffic, e.g. departure ends on dual carriageways or on a one-way road, the minimum Performance Class must be P1.
- (ii) **On roads with a speed limit of less than 50 mph:**
- (a) Terminals must have a minimum Performance Class of P1 or greater.

#### Impact Severity Levels

- 5.6 The ISL for terminals must not exceed Class B in DD ENV 1317-4 (or its successor standard).

**Permanent Lateral Displacement Zones**

5.7 The Design Organisation must specify the maximum permissible PLDZ characteristic for the terminal (DD ENV 1317-4 (or its successor standard) refers and Guidance given below). This must be selected to ensure that adequate clearance of the terminal to any hazard or an area used by motorists or non-motorised users (i.e. behind the VRS installation) is maintained and not compromised. In some situations this may preclude the use of certain terminals (see also Paragraphs 5.9 to 5.10).

**General Requirements**

5.8 Terminals must be provided at the ends of safety barriers unless the Overseeing Organisation agrees to their omission. Justification of a proposal not to use a terminal must be provided with the outcome of the Risk Assessment Process by the Design Organisation.

5.9 In the central reserve only, where it is not possible to use an energy absorbing P4 terminal because of its PLDZ characteristic requirement, a crash cushion must be used.

**Guidance**

**General**

5.10 The performance or mode of operation of some types of terminal may make them unsuitable for use in certain situations, e.g. where there is a hazard close to the end of the full height safety barrier, in the central reserve, where space is limited, or on the elevated approaches to bridges and other structures. Checks should be carried out to ensure, if there are factors that could limit the choice of terminal for a particular situation, that these are clearly identified so that an appropriate choice of terminal is made.

**Permanent Lateral Displacement Zones**

5.11 Each terminal should have its PLDZ characteristics defined by a value of Da and Dd; Da being the maximum deflection in front of the original front face line of the connecting safety barrier, and Dd being the maximum deflection behind the original front face line of the safety barrier.

5.12 If the safety barrier is to be flared to maintain set-back to the end terminal, this should be included in the measurement of Dd.

5.13 The values of Da and Dd are then converted to Classes Code 'x' and 'y' and the displacement characteristics are then referred to as: D.x.y. (although this is not defined in DD ENV 1317-4), (see Table 5-1).

Class Code		Displacement (m)	
x	1	Da	0.5
	2		1.5
	3		3.0
y	1	Dd	1.0
	2		2.0
	3		3.5
	4		>3.5

Table 5-1

Downloaded from https://www.standardsforhighways.co.uk on 08-Jun-2026, TD 19/06 Correction No. 1, published: Feb-2008

5.14 As an example, if a site requires that the terminal displaces no more than 1 m in front of the original front face line of the barrier, then  $D_a$  will have to be 0.5, giving the Class Code value for 'x' of 1. Likewise, if the displacement of the terminal behind the original front face of the safety barrier should be no more than 2.5m, then  $D_d$  will have to be 2.0, giving the Class Code value for 'y' of 2. The PLDZ characteristic for this terminal will be specified as D.1.2. The Contractor would be able to propose a terminal that has either a PLDZ characteristic of either D.1.1 or D.1.2 as long as it also meets with the other specified criteria.

### Impact Severity Levels

5.15 ISL is a measure to compare the potential severity of an injury to vehicle occupants that may result from an errant vehicle impacting two different VRS with different ISL.

### Exit Box Class/Vehicle Redirection Zone

5.16 Each terminal should have its Vehicle Redirection Zone characteristics defined by a value of  $Z_a$  and  $Z_d$ ;  $Z_a$  being the maximum vehicle redirection in front of the original front face line of the connecting safety barrier, and  $Z_d$  being the maximum vehicle redirection behind the original front face line of the safety barrier.

5.17 The values of  $Z_a$  and  $Z_d$  are then converted to a Class Code 'Z' (see Table 5-2). Further information is given in BS ENV 1317-4.

Classes of Z	Approach Side $Z_a$ (m)	Departure Side $Z_d$ (m)
$Z_1$	4	4
$Z_2$	6	6
$Z_3$	4	no limit
$Z_4$	6	no limit

Table 5-2 Exit Box Dimensions/Vehicle Redirection Zones

5.18 Terminals with Exit Box Classes  $Z_3$  and  $Z_4$  should be used with caution because of the unlimited dimension for the Exit Box on the departure side.

## 6. CRITERIA AND GUIDANCE FOR THE PROVISION OF TRANSITIONS

### Performance Class Requirements

#### General

- 6.1 All transitions must conform to the requirements of DD ENV 1317-4 (or its successor standard) and the following criteria.
- 6.2 The Design Organisation must specify, in Appendix 4/1 (MCHW 2), the required Performance Class for each transition installation in terms of Containment Level (e.g. N1, N2, H1, H2 or H4a), Impact Severity Level (ISL) (e.g. ISL Class B) and the Working Width Class (W1 to W8).
- 6.3 The Design Organisation must identify any special requirements with regard to the provision of safety barriers which may affect the choice of system by the Contractor.

#### Containment Levels

- 6.4 Where a transition is used to connect a Very High Containment vehicle parapet (H4a) to a Normal Containment (N1) vehicle parapet, the end section of the Normal Containment (N1) vehicle parapet must be strengthened to Normal Containment Level (N2).
- 6.5 Where a connection is required between a vehicle parapet and a transition, it must be capable of developing the full strength of the transition and if necessary, the vehicle parapet must be strengthened to resist this force.

#### Impact Severity Levels

- 6.6 The ISL for transitions must not exceed Class B in DD ENV 1317-4 (or its successor standard).

#### General Requirements

- 6.7 A transition must be provided at all changes of type and/or Performance Class of Vehicle Restraint Systems (VRS) to provide a gradual change in performance from the first to the second and prevent the hazards of an abrupt variation. DD EN 1317-4 (or its successor standard) gives the Performance Class requirements for transitions.
- 6.8 Where the transition is composed of posts and rails, the end(s) of a terminated upper rail(s) must be treated so as to avoid the possibility of an errant vehicle impacting directly with it.

#### Guidance

- 6.9 The junction between two safety barriers having the same type, cross-section and material, and differing no more than one class of Working Width, is not considered a transition. Changes of type may, for instance, be a change from steel to concrete. Without a transition, this would lead to an abrupt change in dynamic deflection performance characteristics.
- 6.10 If the dynamic deflections of the two different VRS are matched, there will generally not be a problem; however, if the change in dynamic deflection is too great, there is a possibility of 'pocketing' occurring. This is best explained

by example and reference to Figure 6-1. The dynamic deflection of two VRS of the same type of construction is typified by their Working Width categorisations. For example, if a length of deformable safety barrier changes from W6 to W2 Working Width Class without a transition and an errant vehicle hit the W6 safety barrier near to the change in safety barrier type, the W6 safety barrier might deflect locally by say 1.9 m, but then be restrained by the less deformable safety barrier which might only deflect by, say, 0.75 m. The errant vehicle would then in effect hit the end of the W2 safety barrier, causing unacceptably high decelerations to the vehicle and its occupants.

6.11 A similar effect can occur when changing from a deformable VRS to a rigid one, or from a parapet to a stiffer or less deformable safety barrier.

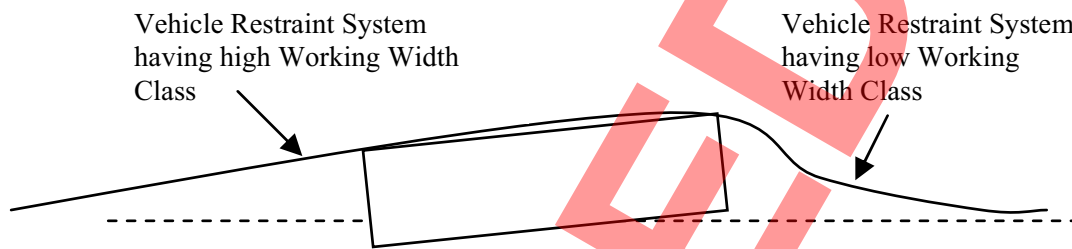


Figure 6-1 Example of Pocketing

6.12 For removable safety barrier sections (e.g. for emergency crossovers) DD EN 1317-4 (or its successor standard) dictates, based on the length of removable section, whether it is to be considered and tested as a single transition or as a different safety barrier connected to the normal barrier by two transitions.

6.13 Depending on the types of VRS being connected, the transition will be designed to have a gradual change in Containment Level or a gradual change in Working Width or a gradual change in both. This is to ensure that there is not a sudden change in stiffness and/or deflection when hit by an errant vehicle. For instance, at a transition between two steel safety barriers of similar profile and height but, say, W2 and W4 Working Width Classes, the post spacing might be altered to provide a suitable transition. As another example, at a change from vertical concrete safety barrier to higher vertical concrete safety barrier, the transition may be a gradual change in both height and cross-section profile.

## 7. CRITERIA AND GUIDANCE FOR THE PROVISION OF CRASH CUSHIONS

### Performance Class Requirements

#### General

7.1 Crash cushions must be compliant with the general Test Acceptance Criteria requirements of BS EN 1317-3, entitled, “Road Restraint Systems: Crash Cushions – Performance Classes, impact test acceptance criteria and test methods” and the following criteria.

7.2 The Design Organisation must specify, in Appendix 4/1 (MCHW 2), the required Performance Class for each crash cushion installation in terms of whether it is Redirective or Non-redirective, Performance Level (100 or 110), Redirection Zone Class (Z1 to Z4), Impact Severity Level (ISL) (e.g. ISL Class B), and the Permanent Lateral Displacement Zone Class (D1 to D8).

7.3 The type of crash cushion (i.e. ‘redirective’ or ‘non-redirective’) and the Permanent Lateral Displacement required must be determined by the Design Organisation relative to the site conditions.

#### Performance Class

7.4 The Performance Class requirements for crash cushions are

(i) **Crash cushions on roads with a speed limit of greater than 50 mph:**

Total Vehicle Mass – 1,500 kgs

Type	Performance Level	Acceptance					
Redirective (R)	110	TC 1.1.100	TC 1.3.100	TC 2.1.100	TC 3.3.110	TC 4.3.110	TC 5.3.110
Non-redirective (NR)	110	TC 1.1.100	TC 1.3.100	TC 2.1.100	TC 3.3.110	-	-

Note Test notation e.g. TC 1.3.100 is as follows

TC	1	3	100
Test of Crash Cushion	Approach	Test vehicle mass	Impact speed

(ii) **Crash cushions on roads with a speed limit 50 mph or less:**

Total Vehicle Mass – 1,500 kgs (nominal)

Type	Performance Level	Acceptance					
Redirective (R)	100 {80 (HA)}	TC 1.1.100	TC 1.2.100	TC 2.1.100	TC 3.2.100	TC 4.2.100	TC 5.2.100
Non-redirective (NR)	100 {80 (HA)}	TC 1.1.100	TC 1.2.100	TC 2.1.100	TC 3.2.100	-	-

### Impact Severity Levels

7.5 ISL must not exceed Class B, as stipulated in Table 4 of BS EN 1317-3.

### Permanent Lateral Displacement Zone Class

7.6 The Design Organisation must specify the maximum permissible Permanent Lateral Displacement Zone Class for the crash cushion (BS EN 1317-3 refers and Guidance given below). This must be selected to ensure that adequate clearance of the crash cushion to any hazard or an area used by motorists or non-motorised users (e.g. behind the Vehicle Restraint System (VRS) installation) is maintained and not compromised.

### General

#### Criteria for the Provision of Crash Cushions

7.7 On a new or improved major road, there is unlikely to be any justification, except in exceptional circumstances, for the installation of crash cushions.

7.8 On existing roads, a crash cushion should only be considered for provision where special features on the highway or particular circumstances warrant its installation.

7.9 At a potential crash cushion site, an evaluation based on the Risk Assessment process must first be undertaken by the Design Organisation of the cost benefit of provision together with possible options for reducing the number, or severity of accidents, by other highway design measures.

7.10 All applications for such provision must be submitted to the Overseeing Organisation (See Paragraph 7.23 et seq.) and must include full details of the site layout, the results of the Risk Assessment process and full details including costings of the alternative options for reducing the number or severity of accidents looked at (including accident details where available).

#### Temporary Traffic Management

7.11 Crash cushions should not normally be included in the designs for Temporary Traffic Management design proposals. They may, however, be proposed by the Contractor.

7.12 Where the use of crash cushions is proposed by the Contractor for safety reasons, the proposals must be supported by an analysis of the benefits of such deployment which takes into account the potential risks to both the workforce and the travelling public.

#### Monitoring of Crash Cushion Installations

7.13 All permanent crash cushion installations must be monitored over a three-year period following deployment. All temporary crash cushion installations must be monitored over the period of deployment. The performance of the installation, in terms of accident numbers and maintenance/repair costs, are to be reported in an agreed format to the Overseeing Organisation.

## Guidance

### General

7.14 Crash cushions are devices that absorb energy at a controlled rate, thereby preventing errant vehicles from impacting fixed and rigid unprotected objects or structures adjacent to the carriageway and thus, minimising the potential injury level of the vehicle occupants. This is achieved by gradually decelerating a vehicle to a safe stop for head-on impacts or, in side impacts, by redirecting the errant vehicle away from the obstruction along the length of the system in a similar manner to that of a safety barrier. A crash cushion designed only to contain impacts on the front of the device is known as 'non-redirecting' and one that allows both end-on and side impacts is a 'redirecting' cushion (See Chapter 1, Figure 1-2).

7.15 A crash cushion may be suitable for deployment in front of an isolated obstruction, which cannot be removed, relocated or be protected by an adequate length of longitudinal safety barrier. A crash cushion can be deployed as an individual VRS or connected to/interfaced with various designs of safety barrier.

7.16 In North America particularly, crash cushions have, for many years, been deployed widely to protect isolated structures and other potentially hazardous features. The design and overall layout of highways in the USA, however, differs significantly from that used in the UK where a much greater deployment of safety barriers is provided in front of, and on the approaches to isolated obstructions or structures adjacent to the highway carriageway.

7.17 In some European countries, like the UK, crash cushions are currently being deployed only at specific locations where an identified safety problem exists. Like safety barriers, crash cushions primarily serve to minimise the severity of an accident when an errant vehicle leaves the carriageway, rather than prevent the accident happening.

7.18 Currently, the crash cushion systems available in Europe are only designed for absorbing the impact of small and large cars. They are not intended to contain/redirect goods vehicles, although systems originating in the USA are generally designed and tested to contain/redirect both a small car and a two-tonne pick-up truck.

7.19 Crash cushion designs range from relatively low cost thin walled plastic barrels filled with varying amounts of sand, to thicker walled 'smart' plastic and steel cylinders, through to more complicated systems incorporating energy absorbing materials and components which compress when impacted. Depending upon the severity of an impact, some systems will need total or part replacement of components, whereas other designs may require minimal maintenance or component replacements.

7.20 Crash cushions are many times more expensive to install than normal safety barriers, for example, 250 m of safety barrier can be installed to protect vehicles from impacting obstructions for the cost of one typical crash cushion.

### Redirection Zone Classes

7.21 For a crash cushion to be acceptable, during tests, the wheels of the test vehicle must not encroach the lines of what is called the Exit Box unless the velocity of the vehicle centre of gravity at the instant of encroachment is less than 10% of the prescribed impact speed. The size of the Exit Box depends upon the Redirection Class of the Crash Cushion. The Exit Box is bounded by the front face of the object that the crash cushion is protecting, a line 6 m in advance of the crash cushion and by lines parallel to and offset from each side of the crash cushion (i.e. 'Za' m offset on the approach side and 'Zd' m offset on the departure side). Table 7-1 below shows the dimensions Za and Zd for each Redirection Zone Class.

Classes of Z	Approach Side Za	Departure Side Zd
Z1	4 m	4 m
Z2	6 m	6 m
Z3	4 m	≥ 4 m, test 3, Figure 1*
Z4	6 m	≥ 6 m, test 3, Figure 1*

\* test 3, Figure 1 are references in BS EN 1317-3

Table 7-1

**Permanent Lateral Displacement Zone Class for Crash Cushions**

7.22 Each crash cushion should have its Permanent Lateral Displacement Zone Class specified according to the Classes given in Table 7-2. The crash cushion under test should remain within distances Da and Dd from the initial face of the crash cushion.

Classes	Displacement	
	Approach Side Da (m)	Departure Side Dd (m)
D1	0.5	0.5
D2	1.0	1.0
D3	2.0	2.0
D4	3.0	3.0
D5	0.5	≥ 0.5, test 3, Figure 1*
D6	1.0	≥ 1.0, test 3, Figure 1*
D7	2.0	≥ 2.0, test 3, Figure 1*
D8	3.0	≥ 3.0, test 3, Figure 1*

\* test 3, Figure 1 are references in BS EN 1317-3

Table 7-2

### Criteria for the Provision of Crash Cushions

7.23 The adoption of the appropriate highway design guidance given in the various Standards and Advice Notes which make up the Design Manual for Roads and Bridges (DMRB), together with the specific guidance set out in Chapter 3 of these Requirements should, in most cases, avoid road layouts that could be regarded as potentially hazardous to an errant vehicle, its occupants and other road users. Consequently, the installation of crash cushions on new or upgraded roads is only likely to be justified in very exceptional circumstances.

7.24 Such exceptional cases may arise, for instance, where landtake difficulties result in Departures from Standards in terms of the geometric layout of the highway. The provision of a crash cushion, however, is not to be regarded as a justification for adopting lower Design Standards.

7.25 Whilst the prevailing conditions at each crash cushion installation site will vary, the majority of the following criteria should be considered within the Risk Assessment process and met before an application for a Departure from these Requirements is submitted to the Overseeing Organisation:

- (i) There is a history of an above average number of accidents at the location involving vehicles impacting an obstruction.
- (ii) The traffic speed limit is 50 mph or above.
- (iii) A significant number of vehicle lane change manoeuvres occurs.
- (iv) Traffic is required to travel in close proximity to the potential obstruction and it is not feasible to install an adequate length of safety barrier in front of, and prior to, the obstruction (e.g. Obstructions located immediately to the rear of a sub-standard diverge nosing).
- (v) The obstruction has a high value to the overall operation of the road network and, if damaged, could cause severe traffic disruption.
- (vi) The highway geometry and cross-section is below desirable minimum standards.
- (vii) The installation is likely to be economically justified both in terms of initial provision and future maintenance.
- (viii) A combination of potential difficulties for drivers exists at the site.

### Temporary Traffic Management

7.26 Where each crash cushion installation is intended to be in position for less than 28 days, the overall benefits to the workforce and road users may be outweighed by the time/cost of installation, the risks to the installation team and possible delays to the travelling public. In short duration works, therefore, crash cushions should not normally be considered unless there are overriding safety reasons.

## 8. CRITERIA AND GUIDANCE FOR THE PROVISION OF TEMPORARY SAFETY BARRIERS AT ROAD WORKS

### Performance Class Requirements

#### General

8.1 All temporary safety barriers installed must be compliant with the Test Acceptance Criteria requirements of BS EN 1317-2: Performance Classes, impact test acceptance criteria and test methods for safety barriers and the following criteria.

8.2 The Design Organisation must specify, in Appendix 4/1 (MCHW 2), the required Performance Class for each temporary safety barrier installation in terms of Containment Level (e.g. N1, N2, H1, H2 or H4a), Impact Severity Level (ISL) (e.g. ISL Class A or B), Working Width Class (W1 to W8).

#### Containment Levels

8.3 The containment levels required for temporary safety barrier are:

**Temporary Deformable and Rigid Safety Barriers**  
(These are classed as safety barriers that are to be in place for less than 4 years.)

- (i) **On roads where road works are being undertaken and a speed limit of 50 mph or more is operative:**
  - (a) Normal Containment Level = N2
  - (b) Higher Containment Level = H1 or H2
  - (c) Very High Containment Level = H4a
- (ii) **On roads where road works are being undertaken and a speed limit of less than 50 mph is operative:**
  - (a) Normal Containment Level = N1
  - (b) Higher Containment Level = H1 or H2
  - (c) Very High Containment Level = H4a

Note: It should be noted that although low angle containment safety barrier systems are referenced in BS EN 1317-2 Table 2, such systems are not recommended in this Standard.

8.4 At temporary or permanent bridge supports and other vulnerable structures, temporary safety barriers with a Very High Containment Level (H4a) must be used unless the Road Restraint Risk Assessment Process (RRRAP) indicates, due to the offset of the support or structure or other factors taken into consideration, that normal Containment Level N1 or N2 is sufficient, or no barrier is required. The principles shown on Figure 8-1 should be followed and the structures assessed in accordance with **BD 48 [DMRB 3.4.7]**.

### Impact Severity Levels

- 8.5 The ISL for temporary safety barriers must not normally exceed Class B as stipulated in BS EN 1317-2.
- 8.6 At specific locations where the containment of an errant vehicle (such as a Large Goods Vehicle) is the prime consideration, or where there is limited space available, a Vehicle Restraint System (VRS) may need to be installed with an ISL greater than Class B. The use of VRS with an ISL greater than Class B must be with the agreement of the Overseeing Organisation and justified by the RRRAP.

### Working Width Classes

- 8.7 The Working Width Class for each safety barrier installation must be the same as or less than that specified by the Design Organisation.
- 8.8 The Design Organisation must specify the greatest Working Width Class that the local temporary and or permanent highway geometry will allow.

### General Requirements

#### General

- 8.9 The Design Organisation must identify within the RRRAP permanent and temporary local hazards, within, or immediately adjacent to, the highway, which have the potential to cause danger to: the occupants of an errant vehicle, the workforce or to Others were an errant vehicle to reach the hazard or workers or give rise to a secondary event. Examples of such hazards are included in the RRRAP and given in the Guidance text.
- 8.10 The RRRAP must be used to record the factors and decisions made in determining the need or otherwise for temporary safety barriers.
- 8.11 Temporary Safety Barriers must be provided where the outcome of the RRRAP indicates that a temporary VRS is necessary to adequately control the risks. Guidance on how the RRRAP works for temporary situations is given in Paragraph 8.27.
- 8.12 The Design Organisation must identify any special requirements, such as design based on a System with/without base plates protruding, with regard to the provision of temporary safety barriers which may affect the choice of System by the Contractor.
- 8.13 Where it is not possible to install a safety barrier to a temporary support to meet the full Working Width requirements, the following relaxation may be considered:
- Where the distance from the traffic face of the safety barrier to the face of the temporary support is less than the Working Width Class of the safety barrier, then the temporary support must be designed to cater for the residual collision load component as given in Table 1 of **BD 60 [DMRB 1.3.5]**.
  - The rear face of the safety barrier must be at least 200 mm from the temporary support to minimise the possibility of any collision loading on the temporary safety barrier being transmitted directly to the temporary support. See Figure 8-1.

- 8.14 A temporary support does not normally need to be designed to resist collision loading if the distance between a line projected vertically from the traffic face of the Temporary Very High Containment Level (H4a) safety barrier and the face of the temporary support is greater than the Working Width Class of the safety barrier for at least 3 m above the adjacent carriageway level.

8.15 The System manufacturer should be contacted to check the dynamic deflection of the temporary safety barrier.

8.16 A temporary safety barrier may be either, permanent type safety barrier, erected temporarily, or a purpose made temporary safety barrier.

**Visibility**

8.17 The requirements stipulated in **TD 9 [DMRB 6.1.2]** in respect of visibility, sightlines over and in front of temporary safety barriers and Stopping Sight Distances must be complied with.

8.18 In difficult situations where the horizontal and or the vertical alignments or other physical hazards temporarily prevent the establishment of the appropriate Stopping Sight Distance requirements stated in **TD 9**, the Design Organisation must apply for a Departure from Standard under **TD 9** to the Overseeing Organisation.

**Set-back**

8.19 Set back for temporary safety barriers must be in accordance with Table 8-1 and the following notes.

Type of Safety Barrier System	Desirable Set-back (70 mph)	Relaxed Set-back (70 mph) Notes A and B	Desirable Set-back (50 mph)	Relaxed Set-back (50 mph or less) Notes A and B
<b>Verge</b>				
System with base plates protruding <sup>(ii)</sup>	1,000	600/700 <sup>(iii)</sup>	600/700 <sup>(iii)</sup>	N/A
System without base plates protruding	1,000	600	600	375
<b>Two-way System</b>				
System with base plates protruding <sup>(ii)</sup>	1,000 (Note C)	N/A	600/700 <sup>(iii)</sup> (Note C)	N/A
System without base plates protruding	1,000	600	600	375

**Table 8-1**

General Notes:

- (i) The System chosen must be sufficient for the expected traffic speed and required containment. There are a number of Systems available with similar appearance but differing containment levels.
- (ii) The term 'System with/without base plates protruding' is generic and Designers must assure the correct provision.
- (iii) There are a number of differing safety barriers with base plates that have differing width. Set-back is measured to exclude base plates; however, for safety barriers with very wide base plates (i.e. wider than 150 mm) the 700 mm set-back should be used. Refer to help menu in RRRAP for measurement of set-back on this type of safety barrier.

Specific Notes:

- A Designers specifying relaxed values of set-back must document the benefits of adopting reduced values, e.g. where extra lanes or extra lane width can be generated, or where other space can be released for operative working and where such space is important. Designers must take account of the many factors (e.g. bends or very long lengths) that could combine to make relaxed values undesirable, including the length of the works. Any increase in risk to drivers may be minimised where lane widths are greater than the minimum in TA 64 [DMRB 8.4.3]. Therefore, when considering selection of relaxed set-back values given in Table 8-1, designers should consider an increase in lane widths. Any values of set-back below the relaxed values will constitute a Departure from Standard and must only be considered where lane widths are greater than the minima in TA 64. As a guide, widths would need to be increased by at least as much as the set-back was reduced below the relaxation value.
- B Chapter 8 of the Traffic Signs Manual (TSM) gives information on where speed limits less than 50 mph may be selected, following a risk assessment. Relaxed set-back values should be included in the risk assessment.
- C Deformable safety barrier deflections may impinge on adjacent lanes after impact and the residual temporary lane width must be sufficient after deflection. Lane widths (prior to deflection of barriers) of 2.65 m for light vehicle lanes and 3.15 m for HGV lanes are recommended.

### Temporary Speed Limits

8.20 A temporary speed limit of 40 mph or 50 mph must not be imposed on roads to protect short sections of work that can be carried out without closure or restriction of any of the running lanes, solely to allow use of temporary safety barriers with a Containment Level of N1. If, in these circumstances, after undertaking a risk assessment, it is considered necessary to provide protection over a short length (e.g. for the replacement of a vehicle parapet) then a temporary safety barrier with a Containment Level of N2, H1 or H4a must be used so that no temporary speed restriction is required. Advice on the use and removal of temporary speed limits can be found in Chapter 8 of the TSM.

8.21 The imposition of a temporary speed limit solely to allow use of temporary safety barriers with a Containment Level of N1 is contrary to Chapter 8 of the TSM.

### Use of Temporary Safety Barriers in Contraflow Operations

8.22 Temporary safety barrier systems can be used in the 1.2 m wide contraflow buffer zone instead of the usual cylinders between lanes of traffic travelling in opposite directions, provided the RRRAP shows a positive benefit and the road geometry is suitable. The following parameters must also apply:

- (i) a reduced temporary mandatory speed limit not exceeding 50 mph;
- (ii) the buffer zone between opposing traffic flows must not be less than 1.2 m wide;
- (iii) the ends of the safety barrier must be continued beyond the end of the contraflow into a coned off area where they can be flared away from the approaching traffic so as to reduce the risk of traffic impacting the ends;
- (iv) an acceptable means of access must be provided, if identified as a necessary measure during the design process, for the Emergency Services and recovery vehicles to attend to accidents or breakdowns within the contraflow;
- (v) there must not be any gaps created in the temporary safety barrier between the two opposing flows of traffic in the contraflow.

8.23 Further Guidance on the use of temporary safety barriers in contraflow situations is given in Paragraph 8.29 et seq.

### Guidance

#### General

8.24 The Specification for Highway Works (MCHW 1) requires that traffic management at road works be in accordance with Chapter 8 of the TSM. Chapter 8 TSM relates primarily to directing traffic through road works using delineators and safety zones rather than the use of VRS such as temporary safety barriers. In Northern Ireland, the Code of Practice for Safety at Street Works and Road Works applies to certain roads. Contact the Overseeing Organisation for details.

8.25 The safety of the workforce is the responsibility of all parties involved in a project not just the Contractor and there is a need to ensure that the workforce and the road user can interact safely. The Construction (Design and Management) Regulations and the Construction (Design and Management) Regulations (Northern Ireland) (which are commonly called the CDM Regulations) in particular impose a duty on the Designer in respect of health and safety of workmen and the public to as far as reasonably practicable: avoid foreseeable risks; combat risks at source; give priority to measures that protect all persons rather than just individuals.

8.26 In some circumstances the Design Organisation will include the requirements for temporary safety barriers in the Works, typically via the tender or contract documents to avoid contractors seeking payment for its provision as a compensation event. Where temporary safety barriers have not been included in the contract and for other projects, they should be provided by the Contractor if his assessment of the risks and method of working indicates the need. In any event, the need will be based on an assessment of the risks and the method of working.

#### The Road Restraint Risk Assessment Process for Temporary Safety Barrier Provision

8.27 It is difficult to accurately model within the RRRAP the many transient situations, hazards, and cost and time related factors that may be present during construction works. For this reason, the RRRAP for temporary situations is based on requiring the Designer to provide responses to a series of questions that will assist in the decision making

process and encourage documentation of that process in a formal and consistent way. The following paragraphs outline the factors to be considered, assessed and recorded in the RRRAP.

### Typical Circumstances Where Temporary Safety Barriers May be Required

8.28 The following is a list of typical circumstances where temporary safety barriers may be required during construction works:

- (i) at temporary or permanent bridge supports and other vulnerable structures which have an inadequate resistance to impact and where the consequences of such an impact may be severe;
- (ii) adjacent to scaffolding or temporary access works where workers or non-motorised road users would be unable to take evasive action;
- (iii) where an existing Road Restraint System will be temporarily removed as part of the works;
- (iv) where a work zone is adjacent to a carriageway open to traffic thereby providing both the works and workforce with a level of protection;
- (v) where there is a high risk of injury to the travelling public if they run into the work zone (such as a traffic lane adjacent to excavations more than 300 mm deep);
- (vi) wherever a substandard highway feature, such as a sharp bend or realignment of the running lanes through temporary traffic management, would suggest an additional risk of an errant vehicle running into the work zone;
- (vii) where the traffic will be temporarily running closer to a hazard where Others could be affected by an errant vehicle, whether or not an existing Road Restraint System is present;
- (viii) where works to overhead power cables are to be undertaken and Skycradles are to be deployed within the highway boundary (See Technical Document (TGN) [T] 47);
- (ix) where contraflow is being considered.

### Use of Temporary Safety Barriers in Contraflow Operations

8.29 The traffic management layouts in Chapter 8 of the TSM and TA 64 [DMRB 8.4.3] do not indicate the use of temporary safety barriers in contraflow working. The installation and operation of the safety barriers themselves can cause difficulties and their use should only be considered where contraflow working is expected to be in place unchanged for periods in excess of 28 days. However, where hazards such as sharp bends or adverse cambers are encountered which may increase the likelihood of cross-over accidents, their use should be considered for shorter periods.

8.30 Deployment of a temporary safety barrier system in the 1.2 m wide contraflow buffer zone (See TA 64), instead of the usual cylinders, between lanes of traffic travelling in opposite directions, will depend upon the space available to accommodate the required set-backs and Working Widths specified in the Contract.

8.31 The benefits of using a temporary safety barrier system are a reduced requirement for maintenance of the buffer zone and a possible reduction in injury from crossover accidents. These benefits, however, must be weighed against the increased risks to road users and the workforce during installation and removal, the costs of delays and the cost of providing temporary safety barriers throughout long lengths of contraflow.

8.32 The use of temporary safety barriers in contraflow situations can adversely affect the ability of the Emergency Services, recovery vehicles and personnel to deal effectively with incidents and treat potential casualties.

8.33 Where a works zone has traffic passing on both sides of the works area and there is also a contraflow configuration in operation, there could be a need to retain an emergency access through the works site. It may be desirable to provide emergency openings, at intervals not closer than 500 m, to and from a works area.

8.34 Individual safety barrier ends should be flared away from the approaching traffic, or protected by cones where this is not possible.

#### Factors Affecting Need for and Choice of Temporary Safety Barriers (Containment Levels of N1, N2 or H4a)

8.35 The use of temporary safety barriers can contribute to the overall safety of both the workforce and the road user. However, such provision may be at a significant cost in terms of time, effort and money. The Design Organisation should consider the following in the RRRAP before deciding whether to include temporary safety barriers in the contract:

- (i) cost of providing, maintaining and removing the temporary safety barrier over and above the cost of normal traffic management using cones and traffic delineators;
- (ii) delays and accident risk to road users and the workforce during the installation and removal of the safety barrier over that of normal traffic management;
- (iii) in a contraflow situation the extra delays to road users from the additional time taken to remove broken down or damaged vehicles due to restricted access and dealing with casualties;
- (iv) savings of maintenance costs over normal traffic management using cones and/or traffic delineators;
- (v) savings in personal injury accidents to road users from the use of Temporary Very High Containment safety barriers;
- (vi) savings in possible injuries to the workforce;
- (vii) savings in possible injuries or damage to Others;
- (viii) savings in the cost of disruption and repair where a structure may be impacted;
- (ix) the time the temporary safety barrier will be in place;
- (x) the implications of the main design factors listed below in Paragraph 8.37.

8.36 The use of temporary safety barriers may also add to the construction cost by making access to works more difficult or restricting the way in which the works can be built, particularly if an emergency lane has to be kept clear. In all cases, it may be helpful to obtain the views of the Police and the other Emergency Services.

#### Design Considerations

8.37 The following are the main design factors that need to be considered by the Design Organisation when using temporary safety barriers at road works:

- (i) Speed limits both existing and proposed.
- (ii) Traffic flows including the percentage of Large Goods Vehicles (LGVs).
- (iii) Containment Level required (i.e. Containment Level N1, N2 or H4a).
- (iv) Length of safety barrier.

- (v) Road alignments, cross-section-pinch points, set-back, headroom clearance, available Working Widths, etc.
- (vi) Sight lines.
- (vii) Drainage of carriageway.
- (viii) Ground support for temporary safety barrier.
- (ix) Clearances for operation and construction.
- (x) Requirements for temporary signing, lighting and road markings.
- (xi) Obstructions that could affect the performance of the safety barrier, e.g. lighting columns, signposts, etc.
- (xii) Other VRS in vicinity of the Works.
- (xiii) Access arrangements for works vehicles, emergency and recovery vehicles.
- (xiv) End of safety barrier details to ensure vehicles cannot pass behind into the work zone.
- (xv) Traffic movements approaching the safety barrier.
- (xvi) Where applicable, the effect of a safety barrier on movement of pedestrians, cyclists, etc.
- (xvii) Maintenance requirements.
- (xviii) Traffic management and working space and widths required for installation and removal of safety barriers.
- (xix) Where a Temporary Very High Containment safety barrier is to be used, whether it should be surface mounted or inset into the carriageway.
- (xx) Compliance with Contract specific details.

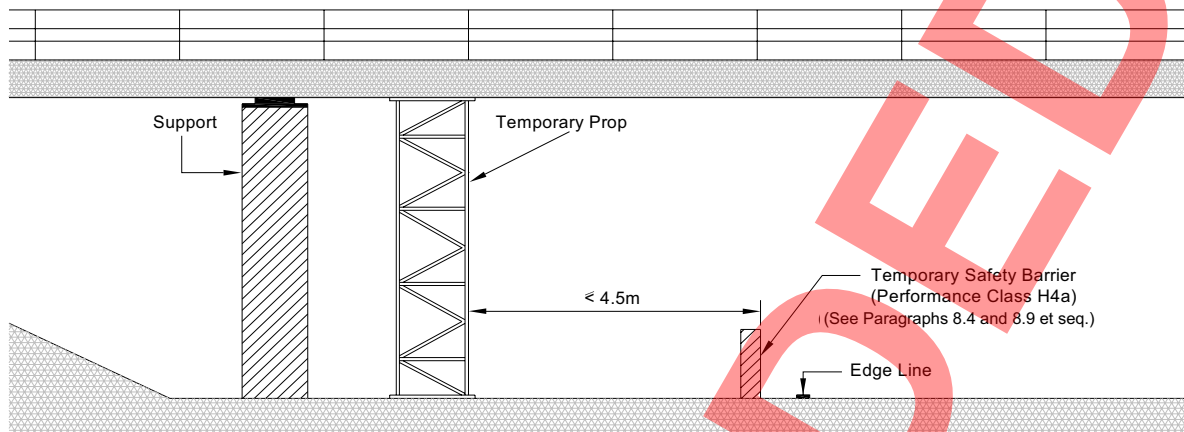


Figure 8-1(a). TEMPORARY SUPPORT LESS THAN 4.5m FROM EDGE OF TRAFFICKED CARRIAGEWAY

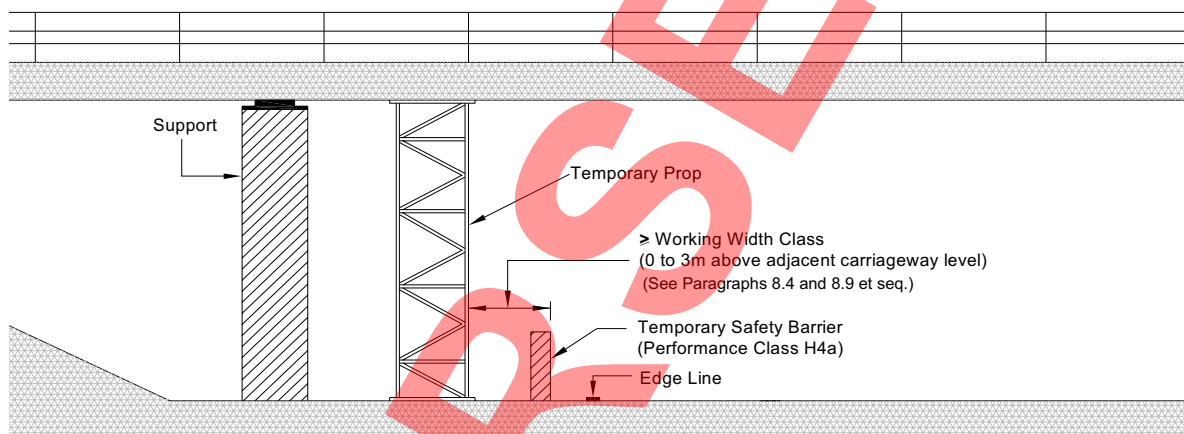


Figure 8-1(b). TEMPORARY PROPPING - NO COLLISION LOADING REQUIREMENT

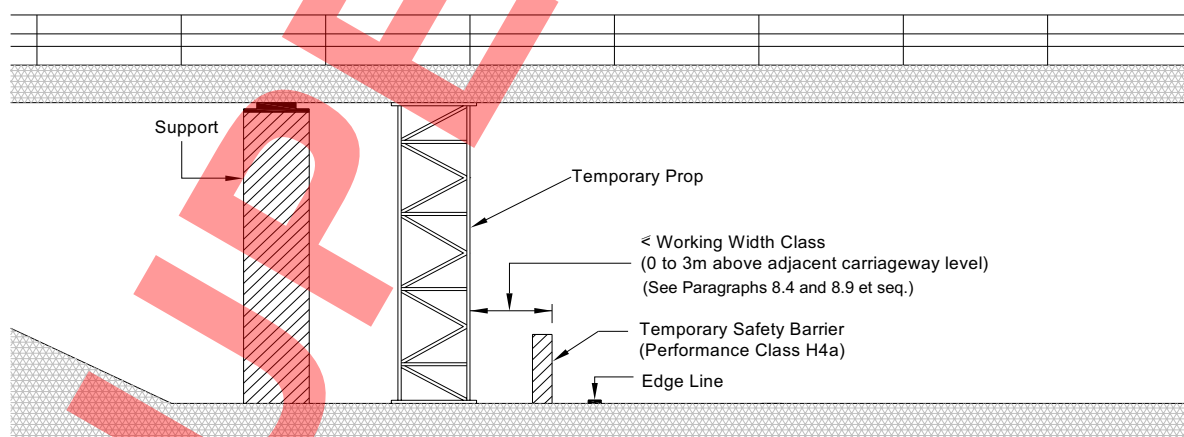


Figure 8-1(c). TEMPORARY PROPPING - TO CARRY RESIDUAL LOADING

**Note:**

1. The Working Width Class shall not be greater than that which can be contained within the available Working Width.
2. For Collision loading requirements see BD60 (DMRB1.3.5).

Figure 8-1 Temporary Safety Barrier Provision Adjacent to Temporary Bridge Supports

## 9. PEDESTRIAN RESTRAINT SYSTEMS

### General

9.1 Two types of Pedestrian Restraint Systems are specified in BS EN 1317-1. These are pedestrian guardrails and pedestrian parapets.

9.2 A draft CEN standard prEN 1317-6 covering pedestrian parapets is currently being prepared, but this draft standard does not include pedestrian guardrails.

9.3 Until such time as the drafting of prEN 1317-6 is completed and formally published, the manufacture and installation of both of these types of pedestrian restraint system on roads must conform to the requirements set out in BS 7818.

### Pedestrian Guardrails

9.4 Guidance on the factors that need to be considered in the design of pedestrian guardrails, such as the length of guardrails, the design class and intervisibility for both pedestrians and drivers, is contained in Annexes A and B of BS 7818.

9.5 Where a guardrail is required for pedestrian safety needs in close proximity to a road with a speed limit of 50 mph or greater, the guardrail, and in particular its end posts, should be located behind a safety barrier [See Figures 9-1(a) and (b)]. At existing sites where space is restricted, layouts as shown in Figures 9-1(c) and (d) may be appropriate.

### Pedestrian Parapets

9.6 All footbridges, cycleway bridges and bridleway bridges must be provided with pedestrian parapets conforming to the requirements of BS 7818.

9.7 Pedestrian parapets must be of framed construction with suitable infilling or solid construction or a combination of these. Framed parapets consisting of posts and longitudinal members must be mounted on a continuous plinth, or have a continuous upstand, at least 50 mm but not greater than 100 mm in height above the adjoining paved surface.

9.8 Pedestrian parapets on bridges over railways are subject to special design requirements with respect to infill panels, as detailed in BS 7818. The infill panels used on the front face of the parapet must be of a design and material approved by the Railway Authority. The requirement for the provision of infill panels on the outer face of parapets at the ends of railway spans given in Chapter 4, must also apply to pedestrian parapets. BS 7818 allows mesh infill over railways with no electrification.

9.9 The minimum height of a pedestrian parapet must be in accordance with Table 1 of BS 7818 and the relevant class of user (i.e. pedestrian, cyclist or equestrian).

9.10 On cycleway bridges or accommodation bridges frequently used by equestrians, the height of the parapet above the adjoining paved surface must be increased to 1800 mm (see Chapter 4 Paragraph 4.23).

9.11 For all bridleway bridges and cycleway bridges where the parapet height is 1800 mm, a 600 mm high solid infill panel must be provided at the bottom of the parapet in order to obstruct an animal's view of the road below.

9.12 All pedestrian parapets must be designed in accordance with the relevant documents contained in the current Technical Approval Schedule (TAS) in **BD 2 [DMRB 1.1.1]**.

9.13 The design load for framed and post and rail pedestrian parapets must be to BS 7818; with the nominal live load of Class 3 (Table 2) for the pedestrian parapet and with the nominal load for the infilling of Class C (Table 3). In exceptional situations where above normal loading is anticipated, pedestrian parapets of Class 4 and/or with Class D infilling may be specified. The use of such high strength pedestrian parapets must be agreed with the Overseeing Organisation.

9.14 Pedestrian parapets of concrete construction must be designed in accordance with BS 5400-4.

9.15 Pedestrian parapets of solid construction must be designed to resist the more severe of a nominal live load of 1400 N/m applied transversely at the level of the top of the pedestrian parapet or wind loading in accordance with **BD 37 [DMRB 1.3]**. The partial load factor  $\gamma_{FL}$  must be taken as 1.5 for live load and 1.4 for wind load at the ultimate limit state or 1.0 for both at the serviceability limit state.

9.16 The strength of infilling panels may be proved for a prototype design by test loading with the loads situated in the most adverse positions. The minimum overload factor must be taken as equal to the product of the partial safety factors used for ultimate limit state design. When the appropriate design document given in the TAS is not to limit state format a 50% overload must be assumed.

9.17 Stone or precast copings used with pedestrian parapets must be secured to the concrete backing by fixings capable or resisting at the ultimate limit state a horizontal force of 33 kN per metre of coping.

#### Pedestrian Restraint and Protection at Head Walls, Wing Walls and Retaining Walls

9.18 Where any pedestrian movement may occur within the highway boundary from use or maintenance of the highway and there is a risk to health and safety from a fall from a height, suitable protective measures must be provided in accordance with the requirements detailed below.

9.19 Where a structure, such as a retaining wall, head wall or wing wall, presents a vertical or near vertical face 1.5 m or more in height and it would be possible for a person to gain access to the upper edge of the structure, a pedestrian restraint system such as a protective barrier or guardrail must be installed close to, or on top of, the structure.

9.20 A pedestrian protective barrier or guardrail must also be installed at walls less than 1.5 m high if a particular hazard, such as a watercourse or road, is in close proximity to the wall.

9.21 Where appropriate, the Vehicle Restraint System (VRS) (if deployed) must be extended to include the approaches to the structure or potentially hazardous differences in ground levels.

9.22 The type of pedestrian protective measure to be used will need to be determined locally and be in keeping with any structural, drainage, environmental and aesthetic considerations. The protective measures could include pedestrian guardrailing, pedestrian parapet or appropriate types of boundary fencing.

## Guidance

### General

9.23 Details and design requirements of various types of fencing, pedestrian guardrails and pedestrian parapets can be found in the **MCHW-3** (Section 1 – Series H), BS 1722 (Various Parts) and BS 7818.

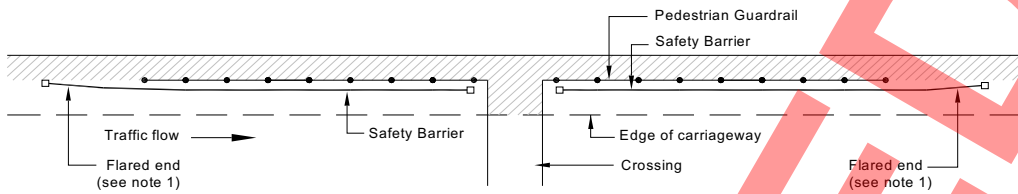
9.24 Pedestrian guardrails should not be provided as a deterrent to kerbside vehicle parking

9.25 Pedestrian parapets may incorporate material other than metal or reinforced concrete provided it has adequate strength and resistance to weathering and vandalism.

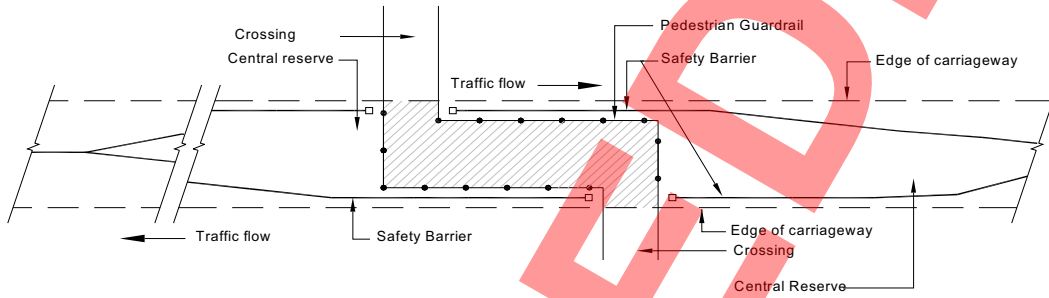
### Pedestrian Restraint and Protection at Head Walls, Wing Walls and Retaining Walls

9.26 Within the highway boundary, retaining walls often support the slope of a cutting or embankment. Also, there are head and wing walls at underbridges, underpasses, subways and culverts. On motorways and many rural all-purpose Trunk Roads, pedestrians are not normally expected to be present near these walls. However, drivers and passengers of broken down or damaged vehicles, maintenance staff, emergency service personnel and others may, on occasion, need to walk near them and there is a potential danger of persons falling from the top of the wall or structure, particularly in poor visibility or adverse weather conditions.

9.27 Examples of locations where pedestrian protective measures would generally be necessary are shown on Figures 9-2 to 9-4 (inclusive).

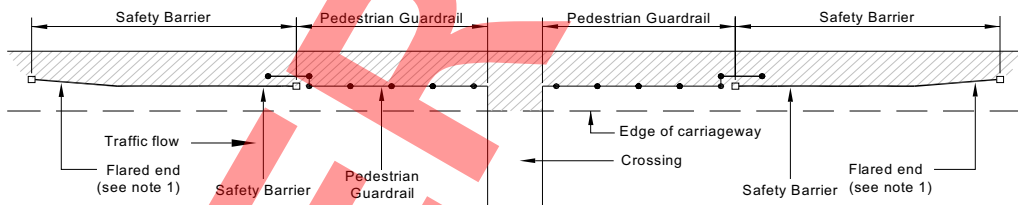


**FIGURE 9-1(a) - SINGLE CARRIAGEWAY OR NEARSIDE OF DUAL CARRIAGEWAY**

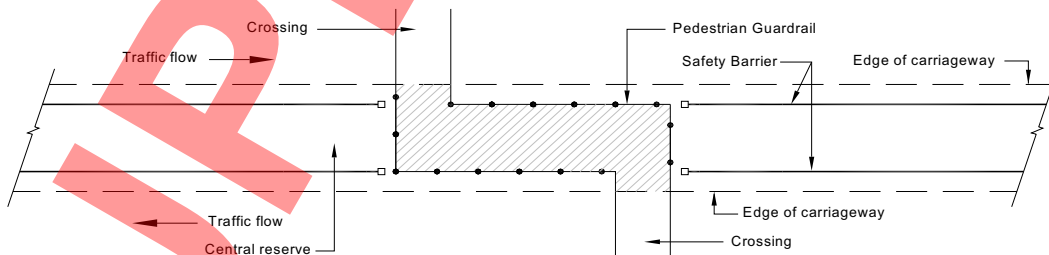


**FIGURE 9-1(b) - DUAL CARRIAGEWAY**

**PEDESTRIAN GUARDRAIL - PROTECTION BY SAFETY BARRIERS  
PREFERRED LAYOUTS FOR NEW CONSTRUCTION OR NEW CROSSING INSTALLATIONS**



**FIGURE 9-1(c) - SINGLE CARRIAGEWAY OR NEARSIDE OF DUAL CARRIAGEWAY**



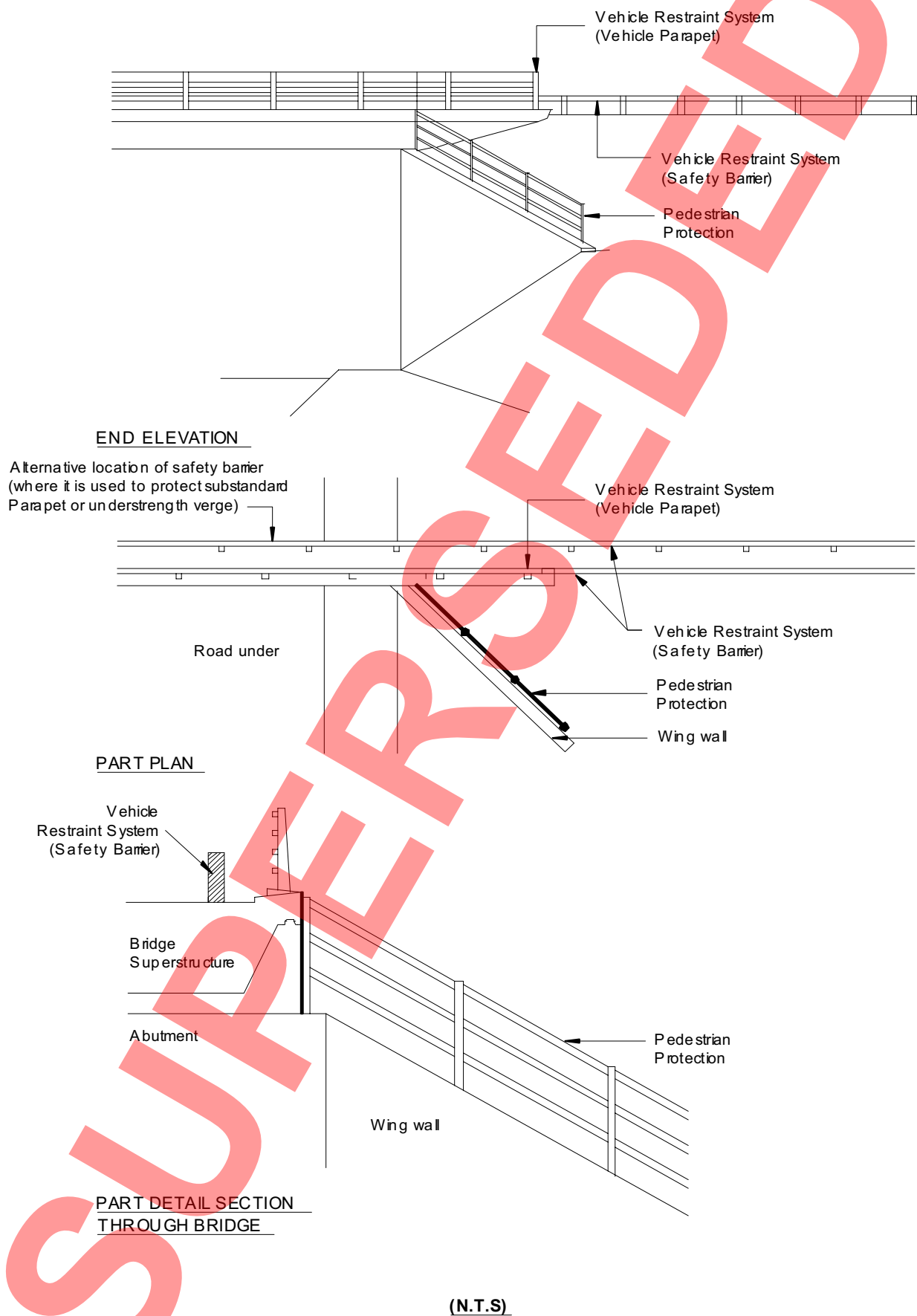
**FIGURE 9-1(d) - DUAL CARRIAGEWAY**

**PEDESTRIAN GUARDRAIL - PROTECTION BY SAFETY BARRIERS  
LAYOUTS FOR EXISTING SITES WHERE SPACE IS RESTRICTED**

**NOTE:**

- 1. Flare only provided where required by manufacturer's system or to maintain set-back to terminal

**Figure 9-1 Safety Barrier Protection to Pedestrian Guardrail**



(N.T.S)  
Figure 9-2 Typical Locations for Pedstrian Protection – Wingwalls

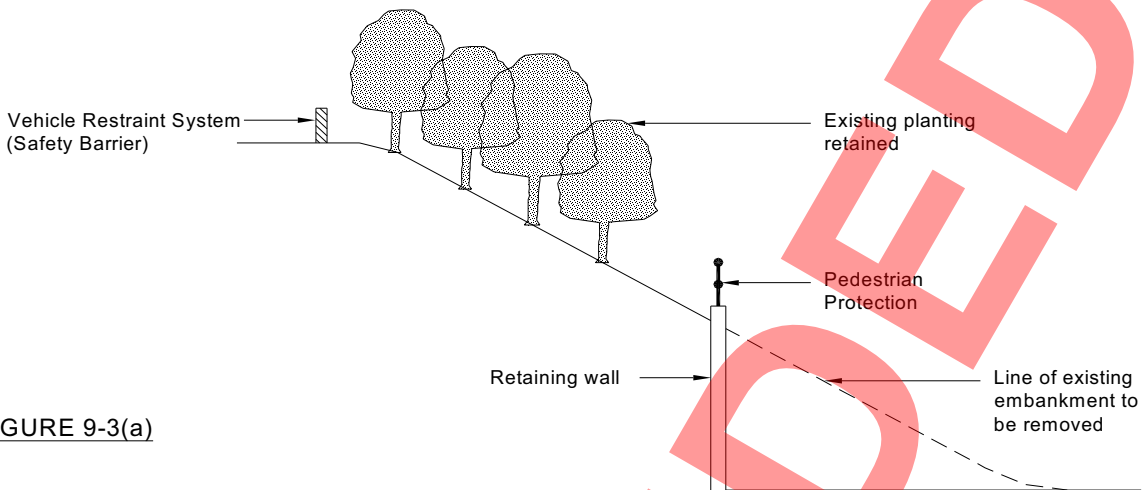


FIGURE 9-3(a)

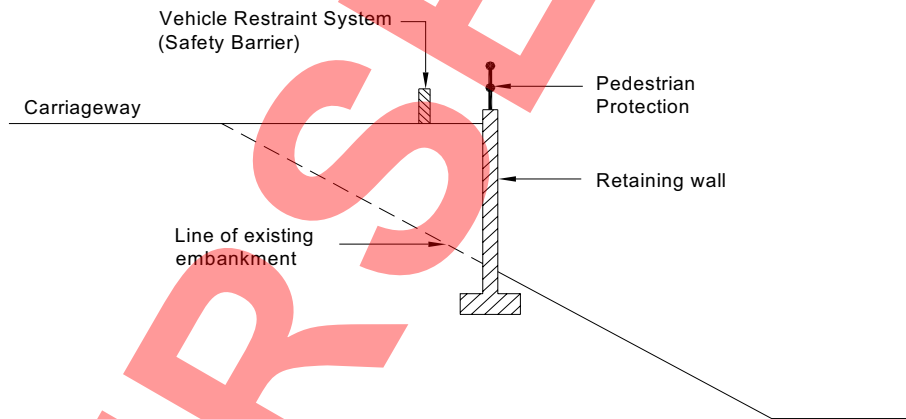


FIGURE 9-3(b)

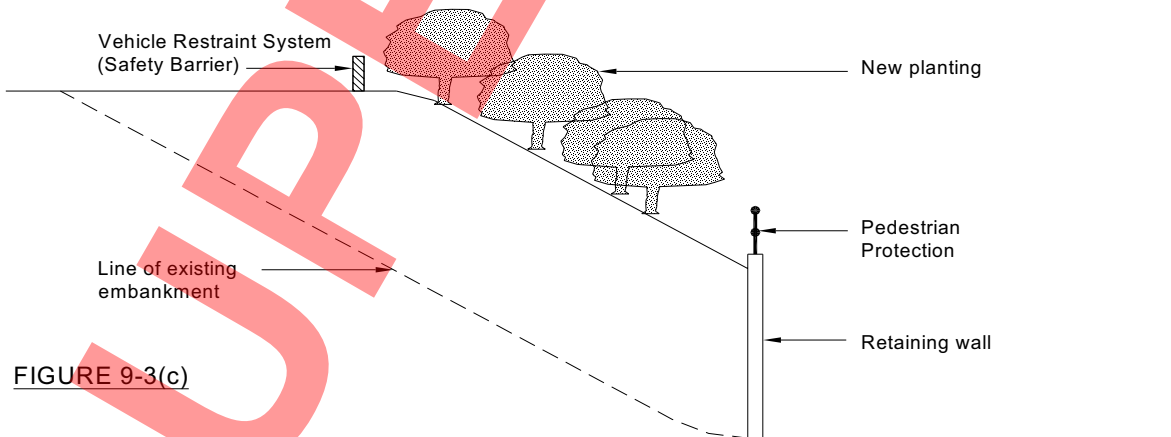


FIGURE 9-3(c)

(N.T.S)

Figure 9-3 Typical Locations for Pedestrian Protection – Retaining Walls

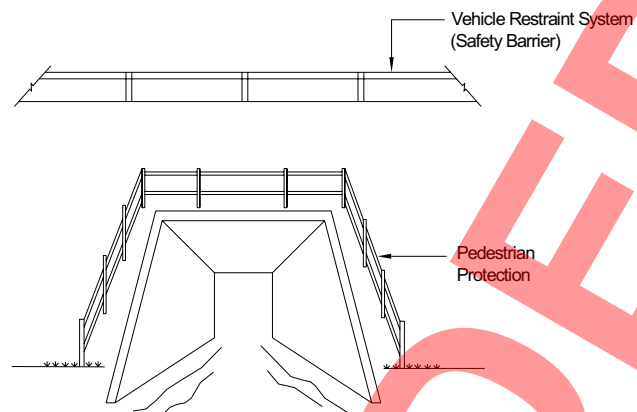


FIGURE 9-4(a)  
RECTANGULAR

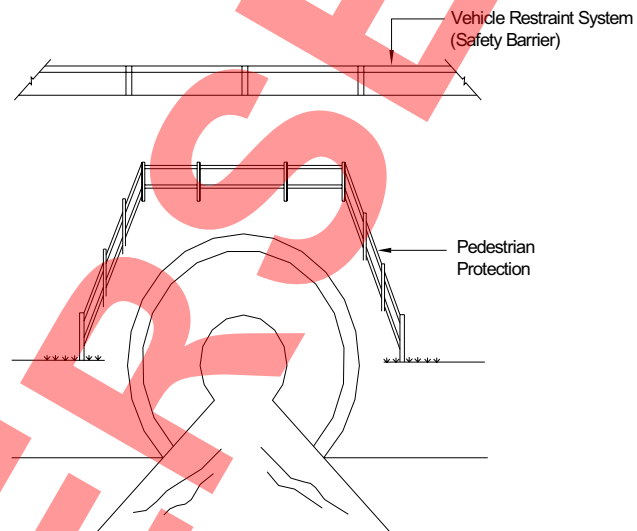


FIGURE 9-4(b)  
CURVED

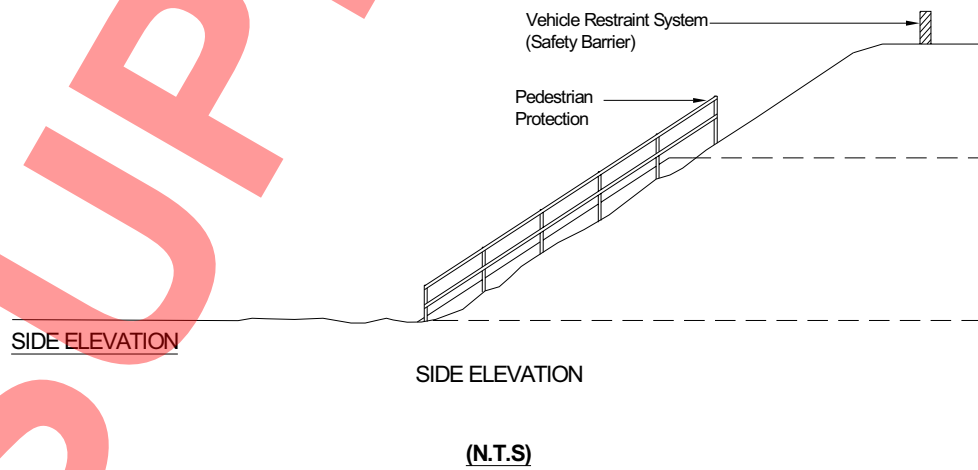


Figure 9-4 Typical Locations for Pedstrian Protection – Culverts

## 10. VEHICLE ARRESTER BEDS

### General

10.1 This Chapter gives advice and guidance on the design and basic construction requirements for arrester beds and sets out the criteria for the provision of this type of Vehicle Restraint adjacent to a highway.

10.2 The function of an arrester bed is to decelerate an errant runaway vehicle on long, steep descending gradients without causing significant damage to the vehicle, its occupants, other road users and adjacent buildings or property. Whilst they are suitable for most types of vehicle, they are particularly effective in bringing to rest large goods vehicles which suffer brakes or gear change mechanism failures.

10.3 There are two basic layouts for arrester beds; those which are incorporated into a separate escape lane leading off from the main carriageway "remote" (Figure 10-1) and those which are constructed adjacent to the nearside of the carriageway in a widened section of the highway "adjacent" (Figure 10-2).

10.4 At severely restricted sites, it may not be feasible to achieve the additional width required to construct a Figure 10-1 or Figure 10-2 layout. In such cases, an arrester bed based on Figure 10-2 but of reduced width, which just accommodates the nearside wheels of a runaway vehicle, may be the only feasible option. This 'single track' type of arrester bed will only have about 50% of the stopping effect of a full width bed and, if deployed, the length of the bed would need to be much longer. At such locations, load shedding of goods vehicles may result, due to the high unbalanced decelerations and also the lowering of the nearside of the vehicle as the wheels sink into the gravel bed. This type of layout should therefore only be considered when there are no suitable alternatives.

10.5 The provision of any type of arrester bed must be agreed with the Overseeing Organisation and supported by a risk assessment.

### Guidance on the Need for an Arrester Bed

10.6 On an existing road where there is a known problem involving runaway vehicles on a downhill gradient, both in terms of personal injuries and damage to vehicles or property, the provision of an arrester bed should be considered.

10.7 If a potential site is on the immediate approach to a built-up area (e.g. rural village), the consequences of an out of control vehicle impacting into adjacent buildings or areas where pedestrians congregate, such as a school and its environs, are potentially very serious. In these circumstances the possibility of constructing an escape lane arrester bed should be investigated in discussion with the relevant local authorities.

10.8 The Design Organisation should consider the possibility of including an escape lane arrester bed on new or improved roads where a long, downhill gradient is unavoidable in the road geometry design and a potential problem associated with runaway vehicles is identified.

10.9 A basic guide for possible provision of an arrester bed in such cases is when the gradient (in percentage terms) squared, is multiplied by the approach length of the gradient from the previous crest (in kms) and a value greater than 60 is obtained. [i.e.  $(\text{gradient } \%)^2 \times (\text{length kms}) > 60$ ].

**Design Considerations**

10.10 Figure 10-1 and Figure 10-2 show the basic layout for both “remote” and “adjacent” gravel filled arrester beds, but each installation will need to accommodate the safety needs of the location, the specific site requirements, and possibly road geometry constraints. Discussions will also need to be held with the relevant local Emergency Services and The Association of Vehicle Recovery Operators (AVRO), to ensure that vehicle recovery from the arrester bed can generally be undertaken safely and without significant delays to other road users.

10.11 Set out in Table 10-1, are suggested lengths (L) for a 380 mm deep (level ground) gravel arrester bed, based on varying approach speeds. (See Figure 10-1 and Figure 10-2).

380 mm bed on level ground	
Expected max entry speed (mph)	Suggested length L (m)
30	25
50	65
60	100
70	120

**Table 10-1 Arrester Bed Dimensions**

10.12 In general, the overall length of a gravel bed should be designed assuming the errant vehicle will be the largest articulated goods vehicle allowed on UK roads, unless vehicles above a specific Gross Vehicle Weight (GVW) are prohibited from the particular road being considered, in which case the maximum permitted vehicle should be designed for.

10.13 The likely speed of vehicle entry into an arrester bed can only be subjective at the design stage based on the prevailing site conditions, but an absolute minimum speed of 60 mph is suggested.

10.14 Other factors, such as the depth and type of aggregate to be used, and also the gradient of the bed, will influence the overall length. Where the arrester bed is aligned on a down gradient, its length should be increased by approximately 3% for each degree of slope.

10.15 Where it is possible on the “remote” escape lane type of arrester bed, a slight up-grade over the length of the gravel bed should be introduced. This can significantly reduce the overall land required for the bed. In these designs however, it is essential that the horizontal alignment of the bed diverges from that of the main carriageway. This is to minimise the potential for the nearside wheels of the errant vehicle being in the gravel bed and the offside wheels being on an increasingly adverse cross slope, which can induce vehicle overturning.

10.16 The gravel bed should be between 4 m and 5 m wide with the depth of material being between 350 mm and 450 mm. Using the 450 mm depth of aggregate can generally produce a 50% higher stopping ability than the 350 mm bed.

10.17 The sides of the bed should be restrained by appropriate kerbing to restrict sideways movement and scatter of the aggregate. On the “adjacent” type of Escape Lane however, it is essential that any kerbing, used for the edge restraint between the gravel bed and the main carriageway pavement, is level with the carriageway so that the errant vehicle driver, who may overshoot the signed entry to the bed, can still steer into the arrester bed. A flush edge on the carriageway side may also facilitate easier retrieval of errant vehicles.

10.18 Clean rounded, uncrushed hard gravel or artificial lightweight aggregate complying with the particle size distribution values shown in Table 10-2 have proved to be extremely effective in allowing the wheels of vehicles to sink into them and thus, achieve the required retardation effect. It is essential that the bed material is free draining and also that the base of the bed is adequately drained to avoid water ponding and potential freezing in winter conditions.

BS Sieve size – Percentage by Mass Passing	
10 mm	100%
5 mm	0%

Table 10-2 Arrester Bed Gravel Particle Size Distribution

10.19 At a very exposed arrester bed, where strong winds can be expected, it may be necessary to cover lightweight aggregate, where used, with suitable netting secured at the edges which, while preventing the aggregate from blowing away, will not adversely affect wheel penetration. Note that lightweight aggregate is a valuable commodity and may be liable to theft.

10.20 Angular gravel, crushed rock and sand are unsuitable materials as they tend to compact with time and also allow vegetation growth which further consolidates the material, thereby preventing the necessary wheel penetration.

10.21 Particular attention should be given to the design and position of the advance signing informing drivers of the existence of an escape lane ahead, and also the signing and markings at the immediate approach to the restraint facility. The wording on these signs may need to also be given in other languages.

10.22 To ensure the entrance to the arrester bed remains clear at all times, it will generally be necessary to introduce Clearway or Waiting Restrictions by means of appropriate Traffic Regulation Order(s).

### Maintenance Requirements

10.23 Generally, escape lane gravel arrester beds do not require much routine maintenance other than ensuring that the signs and road markings are in good order, and the occasional treatment of weeds may be necessary. In severe winter conditions, especially after heavy snowfalls, it may be necessary to apply de-icing materials.

10.24 Consequent to an errant vehicle entering an arrester bed and the subsequent recovery, the restraint facility will need to be promptly reinstated. Aggregate scatter on to the carriageway will need to be removed and the gravel bed reprofiled.

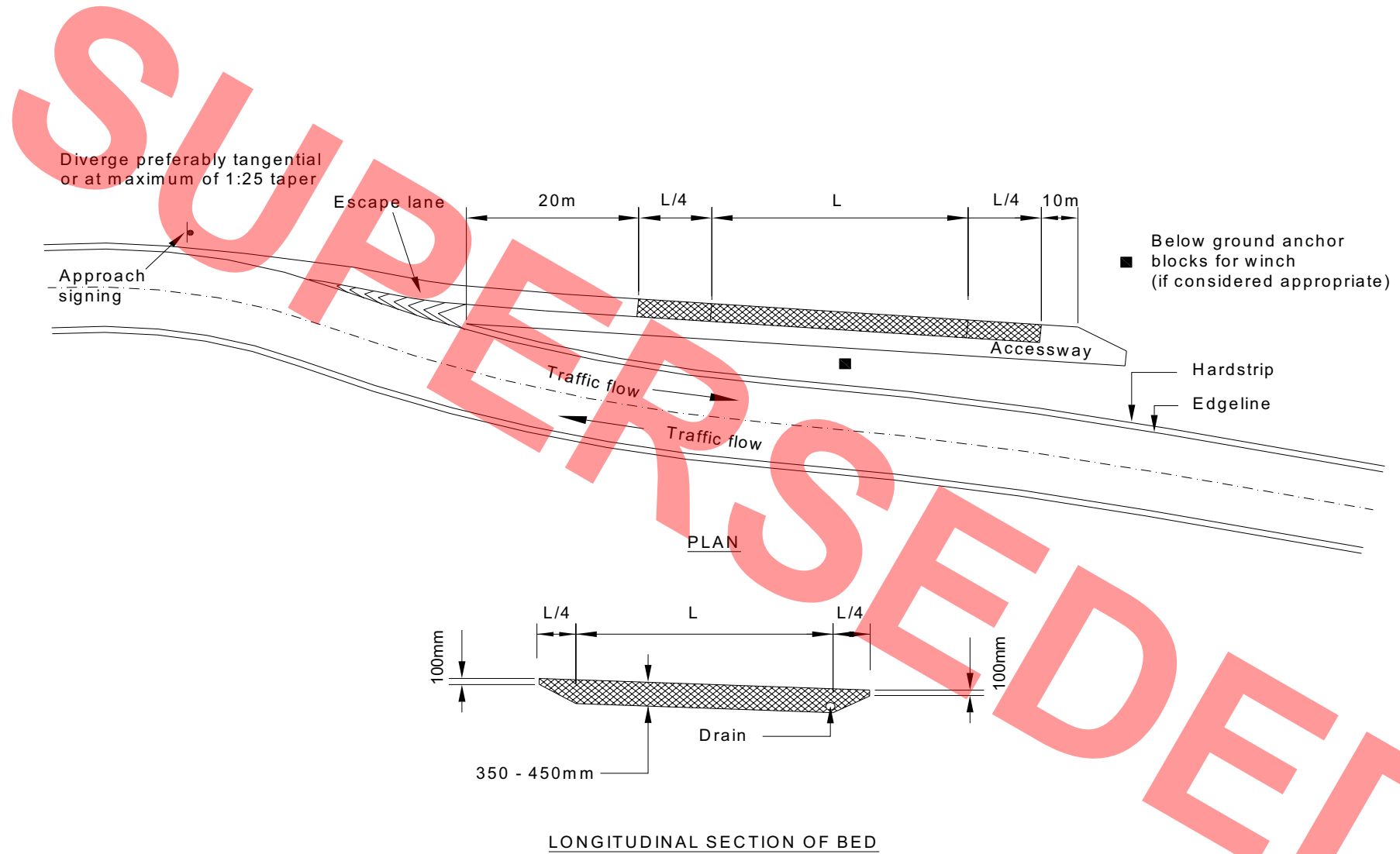


Figure 10-1 Arrester Bed Remote from Carriageway

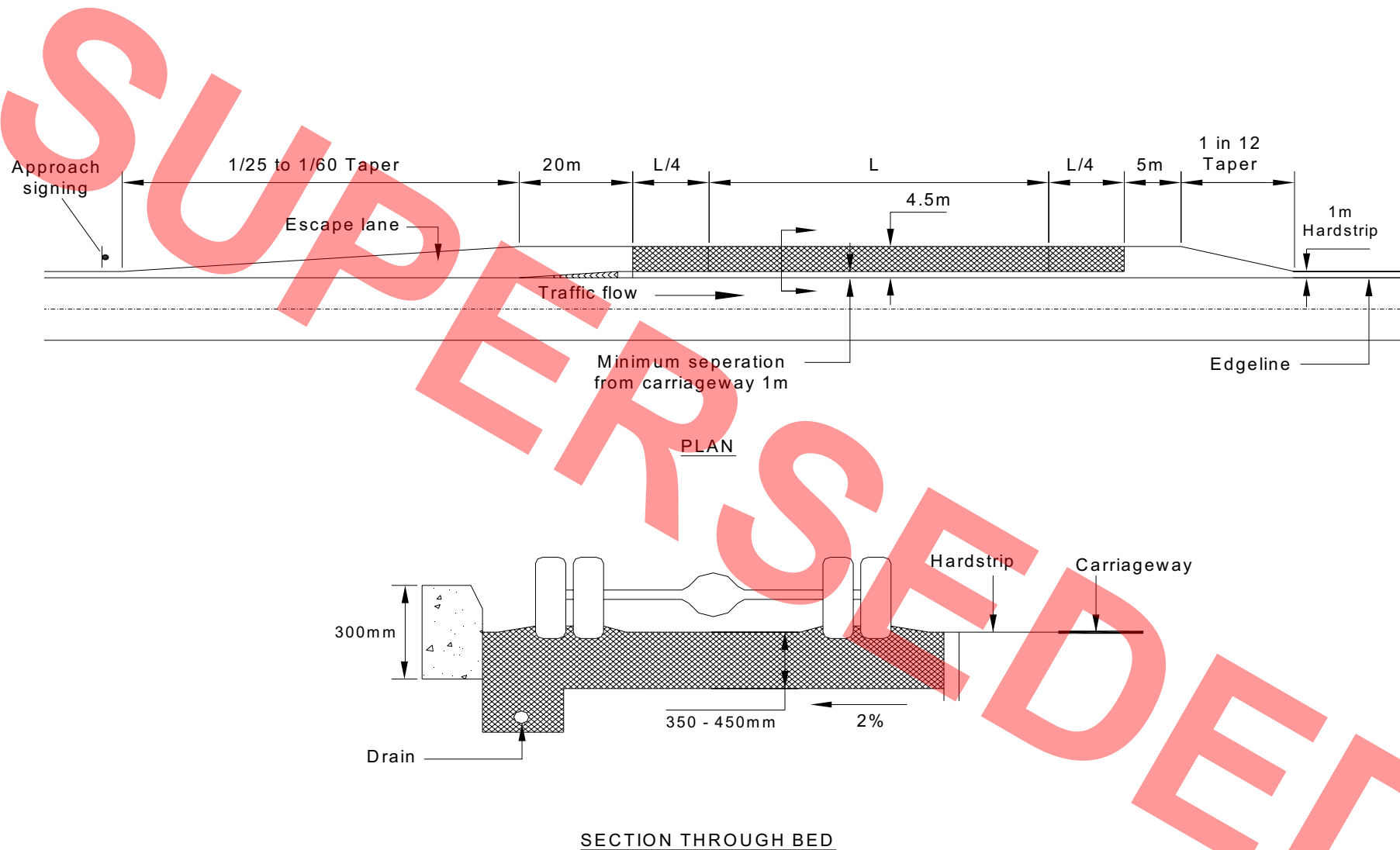


Figure 10-2 Arrester Bed Adjacent to Carriageway

## 11. ANTI-GLARE SCREENS

### General

11.1 The advice given for this topic is applicable to both rural and urban roads.

11.2 There are two standards for anti-glare systems for roads. They are BS EN 12676-1: Performance and characteristics and BS EN 12676-2: Test Methods. All new anti-glare systems must conform to the above standards and the specific requirements described in Appendix 4/1 (MCHW 2).

11.3 The purpose of an anti-glare screen or barrier is to cut off light from oncoming vehicle headlights. They must be designed so that light directed towards the driver at oblique angles ( $12^\circ$  to  $20^\circ$ ) is reduced whilst relatively open vision (around  $70^\circ$ ) is maintained in the sideways direction. The height to effectively screen headlight glare from all types of vehicles on level ground is 2.0 m.

11.4 Screens and barriers can be made of various occluding materials. Where a screen is to be erected in a grass verge it is desirable that it is set in a paved strip to avoid grass-mowing problems. Screens of angled vanes of dense polyethylene mounted above a safety barrier have also been found to be effective in meeting anti-glare requirements in the central reserve of a rural dual carriageway.

11.5 Research carried out on a heavily trafficked motorway where an anti-glare screen had been installed on top of a deformable safety barrier in the central reserve showed drivers experienced no major problems. One effect of the combined safety barrier and anti-glare screen was that the installation caused screen shyness. The effect of screen shyness caused approximately 3% of all car drivers in the middle and offside lanes of a three-lane motorway to change their position away from the safety barrier/screen, by a distance of between 150-250 mm.

11.6 Anti-glare screens have been recorded as creating extra usage of main beam lights to the extent that drivers of preceding vehicles are aware of this. However, there is no significant difference of injury accident rates between screened and unscreened lengths of road when tested; the effects on non-injury accidents were not determined.

### Design Considerations

11.7 Anti-glare screens in central reserves do not appear to significantly alter injury accident rates. At certain locations in built up areas, screens might have the ancillary function of blocking distracting or confusing signs not removable under local planning laws or adjacent roads (e.g. where an access road within an industrial estate lies very close to the road boundary).

11.8 Anti-glare screening may be ineffective where there is severe undulation of the highway alignment particularly and where the proportion of large goods vehicle traffic is high. At exposed locations, screening can also act as a sun block to the carriageway creating potential for frost or ice hazards. Where the highway alignment contains tight right-hand curves, stopping sight distance visibility may also be detrimentally obscured by anti-glare screens leading to greater accident risk. Refer to TD 9 [DMRB 6.1.2].

11.9 The Police Authority responsible for road surveillance and patrol must be consulted prior to the erection of any anti-glare screening which may restrict the police view of the opposing carriageway.

11.10 Anti-glare screens can be particularly effective alongside fast major roads which have an adjacent minor road where, in darkness, opposing headlamps on the nearside cause confusion. At rural locations where swept headlamp paths persistently cross drivers' vision, short lengths of anti-glare screens may be considered.

## 12. REFERENCES

### 1. Manual of Contract Documents for Highway Works [MCHW] - The Stationery Office (TSO)

<http://www.archive2.official-documents.co.uk/document/deps/ha/mchw/index.htm> gives access the Highways Agency's MCHW Volumes 1 and 2 documents.

### 2. Design Manual for Roads and Bridges [DMRB] - The Stationery Office (TSO)

<http://www.official-documents.co.uk/document/deps/ha/dmrbr/index.htm> gives access the Highways Agency's DMRB documents.

- BA 41 The Design and Appearance of Bridges [DMRB 1.3.11]
- BD 2 Technical Approval of Highway Structures on Motorways and other Trunk Roads Part 1: General Procedures [DMRB 1.1.1]
- BD 24 The Design of Concrete Highway Bridges and Structures. Use of BS 5400: Part 4: 1990 [DMRB 1.3.1]
- BD 29 Design Criteria for Footbridges [DMRB 2.2.8]
- BD 37 Loads for Highway Bridges [DMRB 1.3.14]
- BD 44 The Assessment of Concrete Highway Bridges and Structures [DMRB 3.4.14]
- BD 48 The Assessment and strengthening of Highway Bridge Supports [DMRB 3.4.7]
- BD 51 Portal and Cantilever Sign/Signal Gantries [DMRB 2.2.4]
- BD 60 Design of Highway Bridges for Vehicle Collision Loads [DMRB 1.3.5]
- BD 68 Crib Retaining Walls [DMRB 2.1.3]
- BD 83 Design of CCTV Masts [DMRB 2.2.1]
- HA 37 Hydraulic Design of Road-Edge Surface Water Channels [DMRB 4.2]
- HA 56 New Roads Planning, Vegetation and Soils [DMRB 10.1.2]
- HA 83 Safety Aspects of Road Edge Drainage Features [DMRB 4.2.4]
- HA 119 Grassed Surface Water Channels [DMRB 4.2.9]
- HD 19 Road Safety Audits [DMRB 5.2.2]
- HD 46 Quality Management Systems for Highway Design [DMRB 5.2.1]
- TA 64 Narrow Lanes and Tidal Flow Operations at Roadworks on Motorways and Dual Carriageway Trunk Roads with Full Width Hard Shoulders [DMRB 8.4.3]
- TA 66 Police Observation Platforms on Motorways [DMRB 6.3.2]
- TA 67 Providing for Cyclists [DMRB 5.2.4]

- TA 73 Motorway Emergency Telephones [DMRB 9.4.2]
- TA 77 Motorways [DMRB 9.5.1]
- TA 89 Use of Passively Safe Signposts, Lighting Columns and Traffic Signal Posts to BS EN 12767 [DMRB 8.2.2]
- TA 90 The Geometric Design of Pedestrian, Cycle and Equestrian Routes [DMRB 6.3.5]
- TA 91 Provision for Non-motorised Users [DMRB 5.2.4]
- TA 92 Crossover and Changeover Design [DMRB 8.4.6]
- TD 9 Highway Link Design [Incorporating Amendment No 1] [DMRB 6.1.1]
- TD 22 Layout of Grade Separated Junctions [DMRB 6.1.2]
- TD 27 Cross Sections and Headroom [DMRB 6.1.2]
- TD 41 Vehicular Access to All Purpose Trunk Roads [DMRB 6.2.7]
- TD 42 Geometric Design of Major/Minor Priority Junctions [DMRB 6.2.6]

### 3. British Standards and CEN Standards

BS EN 1317-1:1998 Road Restraint Systems – Part 1: Terminology and general criteria for test methods

BS EN 1317-2:1998 Road Restraint Systems – Part 2: Performance Classes, impact test acceptance criteria and test methods for safety barriers

BS EN 1317-3:2000 Road Restraint Systems – Part 3: Crash Cushions – Performance Classes, impact test acceptance criteria and test methods

DD ENV 1317-4:2002 Road Restraint System – Part 4: Performance Classes, impact test acceptance criteria and test methods of terminals and transitions of safety barriers

prEN 1317-5: Road Restraint Systems – Part 5: Product requirements, durability and evaluation of conformity (Draft – September 2004)

prEN 1317-6: Road Restraint Systems – Part 6: Pedestrian restraint systems, Pedestrian Parapet (Draft – February 2003)

BS EN 12767: 2000 – Passive safety of support structures for road equipment – Requirements and test methods

BS 1722: Fences (Various parts)

BS 5400-4:1990 – Code of practice for design of concrete bridges

BS 6100 Sub Section 2.4.1 – The British Standard Glossary of Building and Civil Engineering Terms – Part 2 Civil Engineering, Section 2.4 Highways, Railways and Airport Engineering

BS 6779-1:1998 (Amd. No. 14290, 21 March 2003) – Highway parapets for bridges and other structures – Specification for vehicle containment parapets of metal construction

BS 6779-2:1998 – Highway parapets for bridges and other structures – Specification for vehicle containment of parapets of concrete construction

BS 6779-4:1998 – Highway parapets for bridges and other structures – Specification of parapets of reinforced or unreinforced masonry construction

BS 7818:1995 Specification for Pedestrian restraint systems in metal

BS EN 12676-1: 2000 Anti-glare Systems for Roads – Part 1: Performance and Characteristics

BS EN 12676-2: 2000 Anti-glare Systems for Roads – Part 2: Test Methods

#### 4. Miscellaneous

The Traffic Signs Regulations and General Directions 2002: (SI 2002 No. 3113) Road Traffic – The Stationery Office (TSO)

The Traffic Signs Regulations (Northern Ireland) 1997 (SR 1997 No 386) – TSO

The Traffic Signs (Welsh and English Language Provisions) Regulations and General Directions. 1985 (SI 1985 No. 713)

The Highways Act 1980 – TSO

The Roads (Northern Ireland) Order 1993 (SI 1993 No. 3160) (N.I. 15)

The Construction (Design and Management) Regulations 1994 (SI 1994 No 3140)

Construction (Design and Management Regulations) Northern Ireland (SR 1995 No. 209)

Traffic Signs Manual – TSO

Chapter 8 – Traffic Safety Measures and Signs for Road Works and Temporary Situations

Safety at Street Works and Road Works – A Code of Practice – DTLR

Highways Economic Note No. 1 (HEN 1) – DfT

Guideline for European Technical Approval of Anchors (Metal Anchors) for Use in Concrete (www.eota.be)

Technical Document TGN [T] 47: Design and Use of Skycradles at line crossings of Motorways, other Major Roads and Railways (February 1994: National Grid Company plc)

Interim Advice Note 69 - Designing for Maintenance

(The current Highways Agency's **INTERIM ADVICE NOTES** (IANs) and the latest **INDEX** can be found on the **Official Documents** website:

<http://www.archive2.official-documents.co.uk/document/deps/ha/ians/index.htm>)

#### Quality Management Schemes Publications

([http://www.ukas.com/information\\_centre/publications.asp](http://www.ukas.com/information_centre/publications.asp)).

Scheme 2B – Sector Scheme Document for Vehicle Restraint Systems

Scheme 5A – The Manufacture of Parapets for Road Restraint Systems

Scheme 5B – The Installation of Parapets for Road Restraint Systems

## 13. ENQUIRIES

All technical enquiries or comments on this Standard should be sent in writing as appropriate to:

Chief Highway Engineer  
The Highways Agency  
123 Buckingham Palace Road  
London  
SW1W 9HA

G CLARKE  
Chief Highway Engineer

Chief Road Engineer  
Transport Scotland  
Victoria Quay  
Edinburgh  
EH6 6QQ

J HOWISON  
Chief Road Engineer

Chief Highway Engineer  
Transport Wales  
Welsh Assembly Government  
Cathays Parks  
Cardiff  
CF10 3NQ

M J A PARKER  
Chief Highway Engineer  
Transport Wales

Director of Engineering  
The Department for Regional Development  
Roads Service  
Clarence Court  
10-18 Adelaide Street  
Belfast BT2 8GB

G W ALLISTER  
Director of Engineering

## APPENDIX 1 LISTS A AND B

### LIST A Withdrawn Departmental Standards, Advice Notes and Interim Advice Notes

Document Reference	Title	Date of Issue	Design Manual for Roads & Bridges Reference
TD 19/85 and Amendment No. 1	Safety Fences and Barriers	May 1985 Nov 1986	DMRB 2.2.8
TD 32/93	Wire Rope Safety Fence	Dec 1993	DMRB 2.2.3
TA 45/85	Treatment of Gaps in Central Reserve Safety Fences	June 1985	DMRB 2.2 (See also TA 92 [DMRB 8.4.6])
BA 48/93	Pedestrian Protection at Head Walls, Wing Walls and Retaining Walls	Dec 1993	DMRB 2.2.2
BD52/93	The Design of Highway Bridge Parapets	April 1993	DMRB 2.3.3
IAN 14/98	Use of Crash Cushions	Sept 1998	N/A
IAN 24/98	Use of Temporary Barriers at Roadworks	Dec 1998	N/A
IAN 26/99	TD19/85 Safety Fences and Barriers	May 1999	N/A
IAN 34	Use of Varioguard Temporary Safety Barriers at Roadworks	Jan 2001	N/A
IAN 44/05 (Revision 4)	Interim Requirements for Road Restraint Systems (Revision 1)	August 2005	N/A
IAN 55/04	Guidance on the Use of European Standard BS EN 1317 – Road Restraint Systems	June 2004	N/A
IAN 60/05	The introduction of a New Highways Agency Policy for the Performance Requirements for Central Reserve Safety Barriers on Motorways	Jan 2005	N/A
IRRRS (Revision 1)	Interim Requirements for Road Restraint Systems (IRRRS) (Vehicle and Pedestrian)	Dec 2004	N/A

## LIST B Amendments to Existing Departmental Standards and Advice Notes

Document Reference	Title	Date of Issue	DMRB Reference	Aspect Amended
BD 2/05	Technical Approval of Highway Structures	Aug 2005	1.1.1	Annex A1 Page A/2 Para 3.6, Delete Text “Types of road restraint systems” and replace with “Road Restraint System Requirements”. Annex B1 Page B/3, Delete text “IRRRS/(Date)*” and replace with “TD 19/(Date)* Requirement for Road Restraint Systems”
BD 29/04	Design Criteria for Footbridges	Aug 2004	2.2	Chapter 7 - Paragraph 7.1 Delete “Parapets shall conform to the current requirements of the Overseeing Organisation given in the IRRRS or, when implemented, by EN 1317 Part 6, and the following.” Replace with “Pedestrian parapets shall conform to <b>TD 19 (DMRB 2.2.8)</b> , and the following.”  Chapter 12 -Paragraph 12.5 First sentence after “.. shall be 1.40m” add “(1.5 m when over a railway).”Chapter 13 - References Item 11. Delete “Interim Requirements for Road Restraint Systems (IRRRS)” and Insert “ <b>TD 19 Requirements for Road Restraint Systems (DMRB 2.2.8)</b> ”
BD 51/98	Portal and Cantilever Sign/Signal Gantries	May 1998	2.2.4	Contents Page – Amend text “Annex A Figures 1 to 9” to ‘Annex A Figures 1 and 3 to 9’” Chapter 1 – Introduction. Paragraph 1.9 Amend 2 <sup>nd</sup> sentence as follows: Delete “safety fences” and Insert “safety barriers” Delete “fences” and Insert “safety barriers” Delete “fence” and Insert “safety barrier” Add “[See <b>TD 19 (DMRB 2.2.8)</b> & <b>TD 27 (DMRB 6.1.2)</b> ]” to end of Paragraph. Paragraph 1.17 Delete existing text and Insert “System installed on the road to provide a level of containment for an errant vehicle.” Paragraph 2.14 Delete existing text and Insert “Vehicle restraint systems in accordance with <b>TD 19 (DMRB 2.2.8)</b> shall be provided at gantry supports.” Paragraph. 2.15 Delete all text. Paragraph 2.16. Re-number to 2.15 Paragraph 3.26 Delete “, dependent on the type and set out of restraint system provided as in Figure 2(a).” and replace with “and the requirements given in <b>TD/19 (DMRB 2.2.8)</b> .” Paragraph. 4.21 Amend text to “The horizontal dimensional clearances of the structures and vehicle restraint systems shall be in accordance with <b>TD 19 (DMRB 2.2.8)</b> & <b>TD 27 (DMRB 6.1.2)</b> .” Chapter 8 – References. Section 8.1. Delete “BD 52 Design of highway bridge parapets (DMRB 2.3.3)” and Insert “ <b>TD 19 (DMRB 2.2.8)</b> ”. Amend TD 27 details to “TD 27 Cross-sections and Headroom (DMRB 6.1.2)”.

Document Reference	Title	Date of Issue	DMRB Reference	Aspect Amended
BD 51/98 (contd)				Section 8.4 Remove “BS 6779: Parapets for vehicle containment on highways, Parts 1 and 2:1992 and 1991” Annex A – Delete Figures 2(a) to 2(e) inclusive. Annex B – Item No. 28 Amend “Restraint Systems” to “Vehicle Restraint Systems” and Delete “(Figure 2a)”
BD 68/97	Crib Retaining Walls	Feb 1997	2.1.3	Chapter 6 - Paragraphs 2.23 and 2.24 Add at end of each Paragraph “(See <b>TD 19 (DMRB 2.2.8)</b> )” Chapter 7 – References Section 7.1 Add “ <b>TD 19 Requirements for Road Restraints Systems (DMRB 2.2.8)</b> ”
BD70/03	Strengthened/ Reinforced Soils and Other Fills for Retaining Walls and Bridge Abutments	May 2003	2.1.5	Chapter 2 – References. Add “TD 19 Requirement for Road Restraint Systems (DMRB 2.2.8)” Annex B - B1. Introduction. Paragraph B1.3 Second sub-paragraphs (i) and (ii) Delete “BD 52 (DMRB 2.2.3)” Insert “ <b>TD 19 (DMRB 2.2.8).</b> ” Definitions Paragraph B1.4 After “BS 8006: 1995” Add “and <b>TD 19 (DMRB 2.2.8)</b> for Road Restraint Systems Terminology and Attachment System requirements.” Delete all text for the following definitions: “Vehicle restraint system, Highway parapet, Vehicle parapet, Vehicle pedestrian parapet, Attachment systems and Anchorage.” B2. Design of Base Slabs to Resist Vehicular Collision Effects. Paragraph B2.3.1 Delete “low and normal levels” Insert “Normal and Higher levels” (3 times) Paragraph B2.3.2 Delete “high” Insert “Very High” (twice) Paragraph B2.3.3 Delete “low, normal or high” Insert “Normal, Higher or Very High.” Delete “low and normal levels” Insert “Normal and Higher levels” Paragraph B2.3.4 Delete “high” Insert “Very High” Paragraph B2.11.1 Delete “low, normal and high” Insert “Normal, Higher and Very High” Paragraph B2.11.1.1 For concrete parapets – Delete “high and normal” Insert “Normal, Higher and Very High” For metal parapets – Delete “low, normal and high” Insert “Normal, Higher and Very High” Last sub-paragraph – Delete “high” Insert “Very High” Paragraph B2.11.1.4 – Table: Middle Column Heading – Delete “Low and normal levels” Insert “Normal and Higher levels” Right Hand Column Heading – Delete “High” Insert “Very High” Paragraph B2.11.2. 1 Delete “high” Insert “Very High” Paragraph B2.11.2.2 Delete “high” Insert “Very High” Paragraph B2.11.2.4 – Table: Left hand Column – Delete “high” Insert “Very High”

Document Reference	Title	Date of Issue	DMRB Reference	Aspect Amended
BD 70/03 (contd)				<p>Paragraph B2.16 Table on Page B/10 Table:            Middle Column Heading – Delete “Low and normal levels” Insert “Normal and Higher levels”            Right Hand Column Heading – Delete “High” Insert “Very High”            Figure B2.1 – 2<sup>nd</sup> Box from top – Delete “ low, normal or high” Insert “Normal, Higher or Very High”            Annex B3. (Page B/15) Heading – Delete “<b>HIGH</b>” Insert “<b>VERY HIGH</b>”            Paragraph B3.1 – Delete “high” Insert “Very High” (3 times)            Delete “low and normal levels” Insert “Normal and Higher levels”            Paragraphs B3.4, B3.5, B3.6, B3.7 and B3.9 – Delete “high” Insert “Very High” (5 times)            Figure B3.1 (Page B/16). In Title and 2<sup>nd</sup> &amp; 4<sup>th</sup> Boxes – Delete “high” Insert “Very High”            B5. References. Delete “BD 52 The design of highway bridge parapets (DMRB 2.2.3)”            Insert “<b>TD 19 (DMRB 2.2.8)</b>”</p>
BD 83/01	Design of CCTV Masts	Aug 2001	2.2.11	<p>Chapter 6 Paragraph 6.4            (iii) Delete the whole sub-paragraph.            (iv) Amend to (iii) and Insert new text “located behind a safety barrier conforming to the requirements of <b>TD 19 (DMRB 2.2.8)</b>”</p> <p>Chapter 8 – References. Paragraph 8.2.            Delete “TD 19: Safety Fences and Barriers and TD 32: Wire Rope Safety Fence”            Insert “TD 19 Requirement for Road Restraint Systems (DMRB 2.2.8)”</p>
BD 88/05	Design of Cantilever Masts for Traffic Signals and/or Speed Cameras	May 2005	2.2.13	<p>Chapter 2 General Principles            Paragraph 2.7 Amend (iii) text to “ behind a vehicle restraint system installed in accordance with the requirements of <b>TD 19 (DMRB 2.2.8)</b>”            Paragraph 2.8 and 2.9 Delete            Chapter 3 – Dimensional Limitations            Paragraph 3.3 Delete “.the Overseeing Organisation” and insert “<b>TD 27 (DMRB 6.1.2)</b>”            “Paragraph 3.4 Amend text to read “The lateral distance from the traffic face of the vehicle restraint system to the face of the mast, the Working Width, shall be as specified in the Contract [See <b>TD 19 (DMRB 2.2.8)</b>”            Chapter 10 – References.            Section 10.1 Delete “BS EN 1317-2: 1998 and Title”            Section 10.2 Insert “TD 19 Requirement for Road Restraint Systems (DMRB 2.2.8)”</p>

Document Reference	Title	Date of Issue	DMRB Reference	Aspect Amended
HA 37/97	Hydraulic Design of Road Edge Surface Water Channels	Aug 1997	4.2	<p>Chapter 3 – Safety Aspects.</p> <p>Paragraph 3.1 Delete “safety fence” and insert “safety barrier”</p> <p>Paragraph 3.2 Delete “safety fencing” and Insert “safety barriers” Delete “safety fence” and Insert “safety barrier” (twice) Delete “fence” and Insert safety barrier”</p> <p>Delete “TD 19, Safety Fences and Barriers (DMRB 2.2), TD 32, Wire Rope Safety Fence (DMRB 2.2.3 and HCD (MCHW 3)” and Insert “<b>TD 19 (DMRB 2.2.8)</b>”</p> <p>Paragraph 3.3 Delete “safety fences” and Insert “safety barriers” (twice) Delete “safety fence” and Insert “safety barrier”</p> <p>Paragraph 3.2 Delete final sentence and replace with “The combined layout must comply to the requirements of <b>TD 19 (DMRB 2.2.8)</b> and <b>TD 27 (DMRB 6.1.2)</b>”</p> <p>Paragraph 3.4 Delete “safety fence” and Insert “safety barrier”</p> <p>Chapter 18 – References. Delete “TD 19 Safety Fences and Barriers (DMRB 2.2)” and “TD 32 Wire Rope Safety Fence (DMRB 2.2.3)” Insert “TD19 Requirement for Road Restraint Systems (DMRB 2.2.8)”.</p>
HA 66/95	Environmental Barriers Technical Requirements	July 1994	10.5.1	<p><b>Vehicle Impact</b> – Paragraph 6.9. Delete all text and replace with: “An environmental barrier may require protection by a vehicle restraint system, refer to <b>TD 19 [DMRB 2.2.8]</b>. Where the clearance between vehicle restraint and environmental barrier would be less than 1.5m consideration should be given to combining the environmental barrier with a vehicle restraint system complying with EN 1317.”</p> <p>Paragraph 6.16 Delete whole text.</p> <p>Chapter 11 – References - Add “TD 19 Requirement for Road Restraint Systems (DMRB 2.2.8)”</p>
HA 83/99	Safety aspects of Road Edge Drainage Features	Nov 1999	4.2	<p>Chapter 1 – Introduction. Paragraph 1.2 Delete “or safety fence”</p> <p>Chapter 3 – Paragraph 3.9 Delete existing text and Insert “For the use of kerbs in relation to Vehicle Restraint Systems see <b>TD 19 (DMRB 2.2.8)</b>.”</p> <p>Chapter 4 – Paragraph 4.2 Delete “safety fence” and Insert “safety barrier” (twice) Delete “safety fences” and Insert “safety barriers”</p> <p>Chapter 6 – Paragraph 6.1 Delete “safety fencing” and Insert “safety barriers” Paragraph 6.3 Delete “vertical concrete barriers” and Insert “concrete safety barriers”</p> <p>Chapter 11 – References and Bibliography Delete “TD 19 Safety fences (DMRB 2.2)” and “TD 32 Wire Rope Safety Fences (DMRB 2.2.3)” Insert “TD 19 Requirement for Road Restraint Systems (DMRB 2.2.8)”.</p>

Document Reference	Title	Date of Issue	DMRB Reference	Aspect Amended
HA 113/05	Combined Channel and Pipe System for Surface Water Drainage	Feb 2005	4.2.6	<p>Chapter 2 – Paragraph 2.4 Last sentence Delete “TD 19 Safety Fences and Barriers (DMRB 2.2), TD 32 Wire Rope Safety Fence (DMRB 2.2.3) and the HCD (MCHW 3) in terms of set-back and clearance dimensions and the mounting height of the safety barrier.” Insert “<b>TD 19 (DMRB 2.2.8)</b> and <b>TD 27 (DMRB 6.1.2)</b> regarding the Working Widths and Set-backs specified in the Contract.”</p> <p>Chapter 13 – References. Delete “TD 19 Safety Fences and Barriers (DMRB 2.2).” &amp; “TD 32 Wire Rope Safety Fences (DMRB 2.2.3)” Insert “TD 19 Requirement for Road Restraint Systems (DMRB 2.2.8)”.</p>
HD 46/05	Quality Management Systems for Highway Design	Nov 2005	5.2.1	<p>Appendix D – General (Page D/2) Delete “TA 57 – Roadside Features [Chapter 2 ** S/S by TA 69] – As amended by IAN 44 Appendix 1” Insert “TA 69 – The Location and Layout of Laybys”</p> <p>Appendix D – Fencing (Page D/3) Delete “TA 57 – Roadside Features [Chapter 2 ** S/S by TA 69] – As amended by IAN 44 Appendix 1” Insert “TA 69 – The Location and Layout of Laybys”</p> <p>Appendix D – Vehicle Restraint Systems (Page D/4) Delete “BD 52 – Design of Highway Bridge parapets – As amended by IAN 44 Appendix 1” Delete “TD 19 – Safety Fences and Barriers – As amended by IAN 44 Appendix 1” Insert “TD 19 – Requirement for Road Restraint Systems” Delete “TD 32 – Wire Rope Safety Fence – As amended by IAN 44 Appendix 1”</p>
TA 48/92	Layout of Grade Separated Junctions	Aug 1992	6.2.2	<p>Chapter 4 – Paragraph 4.5 Amend “(TD (DMRB 6.2.1.4.22))” to “TD 22 (DMRB 6.2.1)” Paragraph 4.5 Amend “(DMRB 6.2.1.4.8)” to “(DMRB 6.2.1)” Paragraph 4.6d. Delete “safety fences” Paragraph 4.6e. Delete “fencing” and Insert “barriers”</p> <p>Chapter 5 – Paragraph 5.4 Delete existing text and Insert “The provision of Vehicle Restraint Systems within a junction should be in accordance with <b>TD 19 (DMRB 2.2.8).</b>” Paragraph 5.6 Delete “safety fence” and Insert “safety barrier” Paragraph 5.26 Delete “safety fences” and Insert “safety barriers” (twice)</p> <p>Chapter 7 – References. Delete “TD 19 (DMRB 2.2) – Safety Fences and Barriers: Amendment No. 1:1986” and “TD 32 (DMRB 2.2) – Wire Rope Safety Fences (DMRB 2.2.3)” Insert “TD 19 Requirement for Road Restraint Systems (DMRB 2.2.8)”.</p>

Document Reference	Title	Date of Issue	DMRB Reference	Aspect Amended
TA 57/87	Roadside Features	Jan 1989	6.3	Chapter 4 – Pedestrian Guardrails – Withdrawn [See TD 19 (DMRB 2.2.8)] Chapter 5 – Anti-dazzle Fences – Withdrawn [See TD 19 (DMRB 2.2.8)] Chapter 6 – Arrester Beds – Withdrawn [See TD 19 (DMRB 2.2.8)]
TA 66/95	Police Observation Platforms on Motorways	Jan 1995	6.3.2	Chapter 4 – Layout and Construction. Paragraph 4.1 (iv) Delete “safety fence or” Paragraph 4.4 Delete “BA 48 (DMRB 2.2.2)” and Insert “ <b>TD 19 (DMRB 2.2.8)</b> ” Figure 4/1 Delete “Safety fence or” Figure 4/3 Delete “safety fence or” (twice) Chapter 5 – References. Item 3 Delete “BA 48: Pedestrian Protection at Head Walls, Wing Walls and Retaining Walls, (DMRB 2.2.2)” Insert “TD 19 Requirements for Road Restraint Systems (DMRB 2.2.8)”
TA 71/97	Motorways Overview	Feb 1997	9.3.1	Chapter A5 – Installation Paragraph 2. xiv. Delete “safety fencing” Insert “safety barriers”
TA 77/97	Motorways	May 1997	9.5.1	Chapter C10 – Cabinet Siting. – Delete sub-heading “ <b>Safety Fence</b> ” and Insert “ <b>Safety Barrier Protection</b> ” Paragraph 6. Delete all existing text. Insert “The protection of above ground communications control cabinets, pillars and equipment (other than emergency telephones), should be in accordance with the requirements of <b>TD 19 (DMRB 2.2.8).</b> ”
TA 89/05	Use of Passively Safe Signposts, Lighting Columns & Traffic Signal Posts to BS EN 12767	Nov 2005	8.2.2	Chapter 1 – Paragraphs 1.1 Delete “the Current Standard for Road Restraint Systems [CSRRS]” Insert “ <b>TD 19 (DMRB 2.2.8)</b> ” Paragraph 1.6 Delete “the CSRRS” and Insert “ <b>TD 19 (DMRB 2.2.8)</b> ” Chapter 2 – Paragraph 2.2. Delete “The Current Standard for Road Restraint Systems (CSRRS)” Insert “Departmental Standard <b>TD 19 (DMRB 2.2.8)</b> ” Paragraph 2.3 Delete “the CSRRS.” and Insert “ <b>TD 19 (DMRB 2.2.8)</b> ” Paragraph 2.5 ii. Delete “or any safety fences” Paragraph 2.5 iii. Delete “safety fences” and Insert “safety barriers” Paragraph 2.5 iv. and vi Delete “safety fence” and Insert “safety barrier” Paragraph 2.5 iv. and vi. Delete “safety fences” and Insert “safety barriers” Chapter 3 – Paragraph 3.5 Delete “the CSRRS.” And Insert “ <b>TD 19 (DMRB 2.2.8)</b> ” Chapter 8 References: Section 3 Delete “CSRRS (Current Standard for Road Restraint Systems) this document can be obtained from the Highways Agency by E-mailing a request to HA.IRRRS@highways.gsi.gov.uk” Insert “TD 19 Requirement for Road Restraint Systems (DMRB 2.2.8)”

Document Reference	Title	Date of Issue	DMRB Reference	Aspect Amended
TA 90/05	The Geometric Design of Pedestrian, Cycle and Equestrian Routes	Feb 2005	6.3.5	Chapter 11 – Bibliography. Delete Reference No. 2 “BD 52 (DMRB 2.3.3) The Design of Highway Parapets” Delete Reference No. 11 “Interim Requirements for Road Restraint Systems (IRRRS) (Highways Agency)” Insert new Reference No. 2 “TD 19 Requirement for Road Restraint Systems (DMRB 2.2.8)” Re-number all subsequent Reference Numbers.
TA 91/05	Provision for Non-Motorised Users	Feb 2005	5.2	Chapter 6 – Crossings. Paragraph 6.53 Delete “BD 52 (DMRB 2.3.3)” and Insert <b>TD 19 (DMRB 2.2.8)</b> ”. Chapter 9 – References and Bibliography Delete Reference No. 12 “BD 52 (DMRB 2.3.3) The Design of Highway Parapets”. Insert new Reference No. 12 “TD 19 Requirements for Road Restraint Systems (DMRB 2.2.8)”
TA 92/03	Crossover and Changeover Design	Nov 2003	8.4.6	Chapter 5 – Paragraph 5.5 Delete “the Overseeing Organisation’s Current Standard.” Insert “ <b>TD 19 (DMRB 2.2.8)</b> .” Chapter 7 – References: Section 1. Add “TD 19 Requirement for Road Restraint Systems (DMRB 2.2.8)”
TD 9//80	Highway Link Design Amendment No. 1	June 1993 Feb 2002	6.1.1	Chapter 2 – Sight Distance Paragraph 2.10 Delete “or safety fences” (twice) and Insert “[See TD 19 (DMRB 2.2.8)],” after ‘barriers’ Chapter 3 – Horizontal Alignment Paragraph 3.18 Delete “safety fence or” Chapter 9 – References: Add “TD 19 Requirement for Road Restraint Systems (DMRB 2.2.8)”
TD 27/05	Cross Sections and Headroom	Feb 2005	6.1.2	All references throughout TD 27/05 including Annex A referring to “CSRRS (Current Standard for Road Restraint Systems)” to be Amended to “ <b>TD 19 (DMRB 2.2.8)</b> ” Chapter 7 – References: Add “TD 19 Requirement for Road Restraint Systems (DMRB 2.2.8)”

**APPENDIX 2      GUIDANCE ON THE SPECIFICATION  
OF VEHICLE RESTRAINT SYSTEMS  
FOR LOW SPEED AND/OR LOW  
TRAFFIC FLOW ROADS**

**SUPERSEDED**

The guidance given below is intended to assist practitioners in dealing with situations where the use of a fully compliant vehicle parapet or vehicle safety barrier system may be impracticable or may itself present a similar or greater hazard to the public. These situations, where the application of this Standard is not appropriate, are particularly prevalent on local roads.

Function	Potential Non-Function	Possible Reasons for Non-Function	Assessment Criteria	Commentary
<p><b>Vehicle Parapet</b></p> <p>Vehicle parapet fully compliant to contain and redirect safely.</p>	<ul style="list-style-type: none"> <li>Does not redirect safely.</li> </ul>	<ul style="list-style-type: none"> <li>Redirects effectively, but into oncoming traffic due to narrow carriageway (&lt; 6.0 m)</li> <li>Redirects effectively, but into pedestrians on adjacent footway.</li> <li>Insufficient length of vehicle parapet.</li> </ul>	<p>1) For roads with a speed limit of 50 mph or more use RRRAP within this Standard</p> <p>OR</p> <p>2) For roads with a speed limit of less than 50 mph or traffic flow of less than 5,000 AADT use local in-house risk assessment process to review risk to:</p> <p>a) vehicle occupants and Others below or near to the bridge if vehicle is not contained</p> <p>b) vehicle occupants and Others on the bridge (other traffic and pedestrians) if vehicle is redirected effectively</p> <p>The assessment of risk will include due consideration of actual traffic speed, traffic flows, accident records and the hazards present beneath the bridge.</p>	<ul style="list-style-type: none"> <li>If the risk from lack of containment is acceptable and the risk from effective redirection is unacceptable, then a parapet may not be necessary other than to delineate for pedestrian safety.</li> <li>If the risk from lack of containment is unacceptable and the risk from effective redirection is unacceptable, then a parapet that provides vehicle containment only may optimise the balance of risk.</li> <li>If the risk from lack of containment is unacceptable and the risk from effective redirection is acceptable, then a compliant vehicle parapet system should be used if it is practicable to do so. If not, then any alternative (bespoke) system provided should contain the vehicle and reduce risk to the vehicle occupants to ALARP.</li> </ul>

Function	Potential Non-Function	Possible Reasons for Non-Function	Assessment Criteria	Commentary
<p><b>Vehicle Restraint System</b></p> <p>Vehicle Restraint System on bridge approach fully compliant to:</p> <ul style="list-style-type: none"> <li>Prevent impact on end of parapet.</li> <li>Prevent vehicle travelling behind the parapet to the hazard below.</li> <li>Contain and redirect safely.</li> </ul>	<ul style="list-style-type: none"> <li>An errant vehicle impacts on end of parapet.</li> <li>An errant vehicle gets behind parapet.</li> <li>Does not redirect safely.</li> </ul>	<ul style="list-style-type: none"> <li>Insufficient space to accommodate compliant Vehicle Restraint System due to:               <ol style="list-style-type: none"> <li>Adjacent entrances/junctions restricting length.</li> <li>Verges used as passing bays due to narrow carriageway (&lt; 6.0 m).</li> <li>Insufficient verge/footway width to provide required Set-back/Working Width.</li> </ol> </li> <li>Redirects effectively, but into oncoming traffic due to narrow carriageway (&lt; 6.0 m.)</li> <li>Redirects effectively, but into pedestrians on adjacent footway.</li> </ul>	<ol style="list-style-type: none"> <li>For roads with a speed limit of 50 mph or more use RRRAP within this Standard.</li> <li>OR</li> <li>For roads with a speed limit of less than 50 mph or traffic flow of less than 5,000 AADT, use local in-house risk assessment process to review risk to:               <ol style="list-style-type: none"> <li>Vehicle occupants and Others below or near to the bridge if vehicle not contained</li> <li>Vehicle occupants and Others on the bridge (other traffic and pedestrians) if vehicle is redirected effectively.</li> </ol> </li> </ol> <p>The assessment of risk at the bridge approaches will include due consideration of actual traffic speed, traffic flows and accident records, the hazard faced beneath the bridge and the existence of equivalent hazards elsewhere on the route such as parallel ditches/houses/footways.</p> <ol style="list-style-type: none"> <li>If a non compliant Vehicle Restraint System or none at all is to be used on the approach to the bridge then review the risk arising from impact on end of parapet.</li> </ol>	<ul style="list-style-type: none"> <li>If the risk from access behind the parapet is acceptable and the risk from effective redirection is unacceptable then a Vehicle Restraint System may not be necessary.</li> <li>If the risk from access behind the parapet is unacceptable and the risk from effective redirection is unacceptable then an alternative local Vehicle Restraint System at the bridge that provides vehicle containment only may optimise the balance of risk. Possible solutions could include splayed wing walls or a short (angled) length of barrier. Such bespoke protection should contain the vehicle and reduce risk to the occupants to ALARP.</li> <li>If the risk from access behind the parapet is unacceptable and the risk from effective redirection is acceptable, then a compliant Vehicle Restraint System should be used if it is practicable to do so. If not then protection at the bridge may again be the solution. Such bespoke protection should contain the vehicle and reduce risk to the occupants to ALARP.</li> <li>As a result of (3), a crash cushion may be required here to reduce the consequences of an accidental impact on the vehicle occupants to ALARP.</li> </ul>