**VOLUME 3 HIGHWAY STRUCTURES:
INSPECTION AND
MAINTENANCE**
SECTION 4 ASSESSMENT

PART 3

BD 21/97

**THE ASSESSMENT OF HIGHWAY
BRIDGES AND STRUCTURES**

SUMMARY

This Standard gives criteria for the assessment of highway bridges and structures. It supersedes BD 21/93.

INSTRUCTIONS FOR USE

1. Remove BD 21/93, which is superseded by this Standard, from Volume 3, Section 4, and archive as appropriate.
2. Insert BD 21/97 into Volume 3, Section 4, after Part 2.
3. Archive this sheet as appropriate.

Note: A quarterly index with a full set of Volume Contents Pages is available separately from the Stationery Office Ltd.



THE HIGHWAYS AGENCY



THE SCOTTISH OFFICE DEVELOPMENT DEPARTMENT



**THE WELSH OFFICE
Y SWYDDFA GYMREIG**



**THE DEPARTMENT OF THE ENVIRONMENT FOR
NORTHERN IRELAND**

The Assessment of Highway Bridges and Structures

Summary: This Standard gives criteria for the assessment of highway bridges and structures. It supersedes BD 21/93.

REGISTRATION OF AMENDMENTS

Amend No	Page No	Signature & Date of incorporation of amendments	Amend No	Page No	Signature & Date of incorporation of amendments

SUPERSEDED

REGISTRATION OF AMENDMENTS

Amend No	Page No	Signature & Date of incorporation of amendments	Amend No	Page No	Signature & Date of incorporation of amendments

SUPERSEDED

**VOLUME 3 HIGHWAY STRUCTURES:
INSPECTION AND
MAINTENANCE**
SECTION 4 ASSESSMENT

PART 3

BD 21/97

**THE ASSESSMENT OF HIGHWAY
BRIDGES AND STRUCTURES**

Contents

Chapter

1. Introduction
2. Inspection for Assessment
3. Objectives and Procedures
4. Properties of Materials
5. Loading
6. Analysis of Structure
7. Strengths of Members
8. Sub-structures, Foundations and Walls
9. Assessment for Restricted Traffic
10. References
11. Enquiries

Appendices:

- A C&U and EC Vehicle and Axle Weights
- B Increase in Loading Due to Centrifugal Action
- C Properties of Materials
- D Loading from Vehicles
- E Fire Engines

Contents (continued)

- F Axle Weights for Restricted Assessment Live Loadings
- G Background to Type HA Loading and Assessment Live Loading
- H Background to the Requirements for Masonry Arch Bridges
- J Assessment of Bridge Deck Cantilevers for Accidental Wheel Loading

SUPERSEDED

1. INTRODUCTION

General

1.1 This Standard, for the assessment of highway bridges and structures, was prepared in its original form under the auspices of the Bridges Engineering Division of the Department of Transport, by a working party consisting of representatives from the following organisations at that time:

Department of Transport
Scottish Development Department
Department of the Environment for Northern Ireland
Association of County Councils
Association of Metropolitan Authorities
British Railways Board
London Transport
British Waterways Board.

1.2 This Standard updates and replaces the 1993 version and is to be used in conjunction with the complementary Advice Note BA 16 (DMRB 3.4.4), a 1997 version of which is in the course of preparation. Although the latter is advisory in nature, the principles and methods given in it may be deemed to satisfy the relevant criteria in the Standard. Throughout the Standard reference has been made to appropriate British Standards. Where trunk road structures are to be assessed this Standard should be used in conjunction with the other documents contained in Volume 3, Section 4 of the Design Manual for Roads and Bridges. For non-trunk road structures the following implementation documents may be considered as being particularly relevant:

- (i) BD 34 (DMRB 3.4)
- (ii) BA 34 (DMRB 3.4)
- (iii) BD 46 (DMRB 3.4.1)
- (iv) BD 50 (DMRB 3.4.2)

1.3 If the assessment of any bridge or structure shows it to be inadequate, then the following actions shall be taken:

- (i) Vehicle weight and/or lane restrictions, calculated in accordance with Chapter 9 of this

Standard, shall be applied on the bridge or the bridge shall be propped;

- (ii) If it is considered that further deterioration of the structure may occur in spite of vehicle weight and/or lane restrictions, the condition of the bridge shall be monitored by Special Inspections at intervals not exceeding six months, in accordance with the documents contained in Volume 3, Section 1 of the Design Manual for Roads and Bridges (DMRB 3.1);
- (iii) The bridge shall be closed to all traffic if the structure is assessed to be incapable of carrying even the lowest level of traffic load given in Chapter 5;
- (iv) Replacement or strengthening of the structure to carry full design loading, should be undertaken without undue delay (for trunk road bridges and structures in accordance with the documents contained in Volume 3, Section 4 of the Design Manual for Roads and Bridges (DMRB 3.4).

If, in the course of an assessment, a structure is found to be so inadequate that there is a potential risk to public safety, the procedure described in BD 34 (DMRB 3.4) and BA 34 (DMRB 3.4) regarding urgent action shall be followed. In Wales, any departure from this clause shall be at the discretion of the Director of Highways and the reasons for the decision shall be recorded.

1.4 The timing of the replacement or strengthening of a weak structure will depend on the volume and weight of traffic normally carried by it, and the effect of the traffic restriction on the general transport network in the neighbourhood. If alternative unrestricted crossings are available without involving undue delays or detours, then the replacement/strengthening may be postponed. There may indeed be cases where the cost of replacement/strengthening would represent poor value, and where it would be better to leave the traffic restrictions in force until such time as replacement/strengthening is justified from a value-for-money assessment. However, imposition of any traffic restriction on a particular crossing will increase the volume of traffic on, and hence accelerate the deterioration of, the alternative routes and crossings. This should be taken into account in programming for replacement/strengthening of the weak structures.

1.5 Many of the bridges to be assessed by this Standard are of considerable age and represent important features of our cultural heritage. Their survival to this day owes a great deal to the care of past generations. Where remedial or strengthening works are found to be necessary, the proposals should reflect the duty to retain the character of these structures for the benefit of future generations. Early remedial measures, which restore the carrying capacity and extend the life of these structures, are preferable to urgent reconstruction, as the former not only prove generally to be more cost-effective, but also retain the existing character of these structures.

Scope

1.6 This Standard is intended to be used for the assessment of highway bridges and structures built prior to 1922*, in addition to bridges and structures built after 1922 which were not designed for the equivalent of 30 units of HB loading. It can also be applied to any post-1922 bridge which is thought either to have a reduced loading capacity as a result of deterioration or damage, or to have been designed to sub-standard criteria.

*Note: The first government loading for highway bridges was introduced in 1922 and the first British Standard on loading was published in 1929. This was followed in 1931 by a revised British Standard containing the familiar equivalent uniformly distributed loading curve. HB type loading (or its equivalent) was introduced in the post-war years.

1.7 The Standard covers the assessment of bridges constructed of steel, concrete, wrought iron and cast iron, as well as the assessment of brick and stone masonry arches. It does not cover timber structures or stone slab bridge decks. It also covers the assessment of spandrel walls, sub-structures, foundations, wing walls, retaining walls, dry-stone walls, and buried concrete box type structures.

1.8 The Standard adopts the limit state format with partial safety factors, although there are exceptions in the cases of cast iron construction, and brick and stone masonry arches.

1.9 The Type HA (design) loading given in this Standard allows for the effects of 40 tonne vehicles and includes a contingency margin for unforeseeable changes in traffic patterns. For assessment, reduction factors are applied to the Type HA loading to give the

various Assessment Live Loading levels with no contingency provision. The 40 tonnes Assessment Live Loading covers the effects of vehicles of up to 40 tonnes gross vehicle weight (44 tonnes 6 axles bimodal articulated lorries and draw bar trailer combinations) and 11.5 tonnes axle weight. The 38 tonnes Assessment Live Loading covers the effects of the full range of vehicles allowable under the Construction and Use (C&U) Regulations (see 1.10). For cases where structures are found to be incapable of carrying the full C&U loading, loading criteria are given which correspond to specified limits on gross vehicle weights. Special loading criteria are also given for fire engines.

1.10 The Construction and Use (C&U) Regulations referred to in this Standard are The Road Vehicles (Construction and Use) Regulations 1986 (SI 1986/1078) which came into operation on 11 August 1986. Currently the latest amendment to these Regulations is Amendment No. 6 dated 1995 No. 3051. If there are further amendments affecting the allowable weights and dimensions of vehicles and axles, this Standard will be amended as necessary.

1.11 For arch assessment this Standard is intended to be used in conjunction with Advice Note BA 16 (DMRB 3.4.4), which contains a description of an acceptable method of arch assessment based on the MEXE method. The Advice Note also contains simplified methods of load distribution for certain types of bridge construction, advice on the assessment of dry stone walls, retaining walls, sub-structures and foundations, and some general guidance on maintenance and repair of older types of highway structures. In Northern Ireland the Construction and Use (C&U) Regulations referred to are the Motor Vehicles (Construction and Use) Regulations (Northern Ireland) 1989 which came into operation on 11 September 1989.

Implementation

1.12 This Standard shall be used forthwith for assessments of load carrying capacity of trunk road bridges and other structures, including those structures currently being assessed, provided that, in the opinion of the Overseeing Organisation, this would not result in significant additional expense or delay progress. Its application to particular assessment should be confirmed with the Overseeing Organisation.

Definitions

1.13 For the purpose of this Standard the following

definitions apply:

- (i) **Assessment.** Inspections and determination of load carrying capacity of a structure in terms of either full C&U loading or specified gross vehicle weights.
- (ii) **Assessment Live Loading.** Loads from C&U or other specified vehicles as described in 5.12 - 5.18.
- (iii) **Assessment Loads.** Loads determined for assessment of the structure by applying the partial factors for load, γ_{fl} , to the nominal loads.
- (iv) **Assessment Load Effects.** Load effects determined by applying the partial factor for load effect, γ_{f3} , to the effects of the assessment loads.
- (v) **Assessment Resistance.** The resistance determined by application of a Condition Factor to the calculated resistance.
- (vi) **Arch Barrel.** The single structural arch element formed by one or more arch rings.
- (vii) **Arch Ring.** A single ring of bricks or stones of approximately even size formed to an arch profile.
- (viii) **Bearing.** The structural component used to transmit loading from the superstructure to the substructure.
- (ix) **Bedding.** Mortar and other material under the baseplate of a bearing.
- (x) **Bogie.** Two or three 'closely spaced' or 'adjacent' axles as described in the Construction and Use (C&U) Regulations.
- (xi) **Calculated Resistance.** The capacity of the structure or element determined from material strengths and sections properties by applications of partial factor for material strength, γ_m .
- (xii) **Centrifugal Effects.** Radial forces and changes to vertical live loading due to vehicles travelling in a horizontally curved path.
- (xiii) **Condition Factor.** Factor which accounts for deficiency in the integrity of the structure as described in 3.18.
- (xiv) **Construction and Use (C&U) Regulations.** Regulations governing the use of normal vehicles on the highway - see 1.9.
- (xv) **Dead Load.** Loading due to the weight of the materials forming the structure or structural elements but excluding superimposed dead load materials.
- (xvi) **Leaching.** The removal of material, usually lime, from concrete or masonry by the percolation of water.
- (xvii) **Limit State Principle.** The design concept adopted in BS 5400 and outlined in ISO 2394 'General Principles for the Verification of the Safety of Structures'.
- (xviii) **Live Loads.** Loading due to vehicle and pedestrian traffic.
- (xix) **Loaded Length.** The base length of that area under the live load influence line which produces the most adverse effect at the section being considered.
- (xx) **Masonry Arch.** An arch built of brick or stone masonry.
- (xxi) **Modified MEXE Method.** An empirical method for the assessment of masonry arch bridges as described in BA 16 (DMRB 3.4).
- (xxii) **Notional Lane.** A notional part of the carriageway assumed solely for the purpose of applying specified live loads.
- (xxiii) **Nominal Loads.** Nominal loads for assessment are derived from design nominal loads (defined in BS 5400 : Part 2), using reduction factors where applicable.
- (xxiv) **Permissible Stress.** The stress which it is safe to allow under specified assessment loading (for cast iron bridges only).
- (xxv) **Seating.** The even and correct meeting of contact surfaces.
- (xxvi) **Spandrel Wall.** Wall which is founded on the edge rib of an arch barrel to restrain the bridge infilling.
- (xxvii) **Spalling.** The detachment of fragments, usually

flaky, from a larger mass by a blow or by the action of weather or internal pressure (such as that exerted by rusting reinforcement).

(xxviii) Superimposed Dead Load. The weight of all materials forming loads on the structure but which are not structural elements, such as surfacing, parapets, spandrel walls, service mains, ducts, miscellaneous street furniture, etc.

(xxix) Ultimate Limit State. Loss of equilibrium or collapse (see BS 5400 : Part 1 for a more comprehensive definition).

(xxx) Voussoir. Wedge-shaped masonry unit in an arch.

Note: Reference may also be made to other definitions given in the appropriate parts of BS 5400.

Symbols

1.14 The following symbols are used in this Standard:

A	Cross-sectional area
a	Strut material factor
b_{fe}	Effective flange width
b_L	Notional lane width
D	Overall depth of deck
d	Depth of girder at midspan
E	Modulus of elasticity
F	End fixity factor
F_A	Centrifugal effect factor
F^c	Overall condition factor
F^{cm}	Condition factor
f_c	Comprehensive yield stress
f_d	Permanent load stress for cast iron
f_k	Characteristic (or nominal) strength
f_L	Live load stress for cast iron
f_p	Permissible stress of cast iron
g	Acceleration due to gravity
k	Reduction factor for pedestrian live load.
K	Reduction factor
K_r	Least radius of gyration
L	Loaded length
L_s	Strut length
L_t	Dispersion length for troughing
m_{fw}	Shear resistance ratio
P	Safe load
Q_A^*	Assessment loads
Q_K	Nominal loads
q_d	Permanent load shear stress for cast iron
q_L	Live load shear stress for cast iron
R_A^*	Assessment resistance

R^*	Calculated resistance
r	Radius of curvature of carriageway
S_A^*	Assessment load effects
t_f	Flange plate thickness
v	Speed of vehicle
w	Unit load per metre of lane
W_L	Longitudinal line load or point load
W_t	Troughing load
Z_p	Plastic modulus
γ_{fL}	Partial factor for load
γ_{f3}	Partial factor for load effect
γ_m	Partial factor for material strength

2. INSPECTION FOR ASSESSMENT

General

2.1 The assessment of a structure for its load carrying capacity involves not only analysis and calculations but also the inspection of the structure concerned. Such inspection is necessary to verify the form of construction, the dimensions of the structure and the nature and condition of the structural components. Inspection should cover not only the condition of individual components but also the condition of the structure as an entity and especially noting any signs of distress and its cause.

2.2 Requirements for inspection to determine loads and resistances are given in 2.4 and 2.5 respectively, and further criteria for the inspection of arch barrels are given in 2.10. The requirements given in 2.4 and 2.5 cannot be applied to the inspection of spandrel and dry-stone walls because the assessment of these structures has to be based on qualitative judgements of the information obtained from their inspection (see 3.1 to 3.3), and specific requirements are given in 2.14 and 2.19. The general requirements need also not be applied to other types of retaining walls, wing walls, sub-structures and foundations when it is judged that the adequacy of these structures can be assessed without analysis and calculation. Specific requirements for their inspection are given in 2.16. However, when there is some doubt concerning the adequacy of these latter structures, particularly with regard to sub-soil conditions or backfill pressures, and/or if signs of distress are apparent, the inspection procedures given in 2.4 and 2.5 shall be followed, where possible, in order that an analytical approach can also be adopted.

Advice on inspection procedures is given in the documents contained in Volume 3, Section 1 of the Design Manual for Roads and Bridges (DMRB 3.1). It should also be noted that General Inspections are unlikely to be adequate for assessment purposes.

2.3 Prior to undertaking the inspection of a structure, all existing information pertaining to the structure should be collected including as-built drawings, soils data and past inspection reports. This may be of use in determining what further information should be obtained from the inspection and which items require special attention.

Inspection for Loading

2.4 The structure shall be inspected to determine the density and dimensions needed to calculate the nominal loads Q_K (see Chapters 3 and 5). Care shall be taken to obtain an accurate estimate of dead and superimposed dead loading by undertaking a detailed geometric survey of the structure, reference being made to as-built drawings when available. Loads due to excessive fill, previous strengthening operations and installation of services shall be included. Trial holes or boreholes may be required.

The live loading depends on the number of traffic lanes that can be accommodated (see 5.6). The clear width of carriageway and position of lane markings shall be recorded. Similarly, the horizontal road alignment, when curved on the structure, shall be determined to permit the calculation of centrifugal loads (see 5.39 to 5.41).

Inspection for Resistance

2.5 The structure shall be inspected to record all the parameters needed to determine the strength of members and elements, including possible deficiencies, eg cracks, corrosion, settlement, defective materials, damage, etc. The inspection should provide confirmation of the information obtained from documents, particularly:

- (i) dimensions of internal sections that may not be related to external features;
- (ii) previous strengthening;
- (iii) reduction in strength due to services laid through, or near the structure.

2.6 All constituent parts of the superstructure shall be inspected to determine their respective strengths. Members susceptible to fatigue shall be closely examined for cracks. Samples may be required for testing to determine yield stresses of metal members and reinforcement or strengths of concrete, brickwork, stone masonry and mortar. Chapter 7 gives details of the requirements for the determination of strength of members.

2.7 With regard to buried members, where there is doubt on the above parameters, excavation of trial holes

should be considered.

2.8 Reference shall be made to as-built drawings when available. However, care shall be taken when using a limited number of drawings that exist for old structures, because such documentation is often neither accurate nor reliable.

Masonry Arch Bridges

General

2.9 The external fabric should always be inspected. Probing into the construction will be necessary where the strength of the bridge is in doubt or if internal scour and leaching of the fill is suspected. The road surface and roadway structure shall also be examined for signs of rupture or other damage.

Arch Barrel

2.10 The arch barrel shall be inspected to record all the information needed to determine the loading and resistance in accordance with 2.4 and 2.5. In particular the following information shall be obtained:

- (i) Nature and condition of the brickwork or stonework including the location and extent of any crushing;
- (ii) Thickness of the joints and depth of mortar missing;
- (iii) Condition of the mortar;
- (iv) Presence of cracks - their width, length, position and number;
- (v) Location of any displaced voussoir;
- (vi) Deformation of the arch barrel from its original shape;
- (vii) Any additional strengthening rings, or saddling.

2.11 The above information is also required for the use of the modified MEXE method. See BA 16 (DMRB 3.4.4).

2.12 The inspection should provide further confirmation of any information already obtained. For example:

- (i) The thickness of the arch ring under the parapet can be measured, but it does not follow that the thickness is the same under the roadway;
- (ii) Some old bridges have been strengthened by removing the fill and replacing it with concrete;
- (iii) Services which are laid over or through the arch rings may affect the strength. The position and size of these should be determined.

2.13 Where there is doubt about any of the above conditions, a site investigation shall be made, including the digging of trial holes when necessary.

Parapets and Spandrel Walls

2.14 Parapets and spandrel walls shall be inspected to obtain evidence of any defects and their extent recorded, eg:

- (i) Tilting, bulging or sagging;
- (ii) Lateral movement of parapet or spandrel wall relative to the face of the arch barrel;
- (iii) Lateral movement of parapet or spandrel wall accompanied by longitudinal cracking of arch barrel;
- (iv) Weathering and lack of pointing;
- (v) Evidence of vehicular impact;
- (vi) Cracking, splitting and spalling;
- (vii) Loosening of any coping stones.

Abutments, Piers, Foundations and Wing Walls

2.15 Inspection of arch bridge abutments, foundations and wing walls shall be in accordance with 2.16.

Sub-structures, Foundations, Retaining Walls and Wing Walls

General

2.16 Sub-structures and foundations are taken to represent all elements of the bridge beneath the soffit of the deck, including bearings, piers, bank seats, abutments, wing walls, piles and foundations rafts. In the case of arches the sub-structure and foundations

include the springings and all elements beneath the ground. All accessible parts of the sub-structures, foundations and wing walls shall be examined and any defects noted. Retaining walls and their foundations shall be similarly examined except for dry-stone walls where the specific requirements of 2.19 apply.

For sub-structures founded in water, underwater inspection of the submerged sub-structure and foundations are required to determine their condition.

Bearings

2.17 The presence or otherwise of bearings shall be noted, and if present, they shall be inspected to obtain information on the following:

- (i) General condition of bearings;
- (ii) Any binding or jamming, looseness or reaching the limit of movement;
- (iii) Condition of seating, bedding and plinth;
- (iv) Whether correct operation of the bearings is prevented or impaired, eg by structural members built into abutment or pier.

Piers, Bank Seats, Abutments, Retaining Walls and Wing Walls

2.18 The inspection shall obtain information on whether the following defects are present and, if so, their extent:

- (i) Tilting and rotation, in any direction;
- (ii) Rocking;
- (iii) Cracking, splitting and spalling;
- (iv) Erosion beneath water level;
- (v) Weathering and other material deterioration, including lack of pointing for masonry and brickwork;
- (vi) Growth of vegetation;
- (vii) Lack of effective drainage;
- (viii) Internal scour, and leaching of fill;
- (ix) Settlement of fill.

Dry-stone Walls

- 2.19 Dry-stone walls shall be inspected for evidence of defects, and their extent recorded, eg:
- (i) Partial collapse;
 - (ii) Bulging or distortion in isolated areas or widespread cracking of masonry;
 - (iii) Loss of masonry;
 - (iv) Weathering and leaching of the fabric of the wall both on the face and internally;
 - (v) Harmful vegetation and its nature.

3. OBJECTIVES AND PROCEDURES

General

3.1 The objectives of assessment shall be to determine, in terms of vehicle loading, the load that a given structure will carry with a reasonable probability that it will not suffer serious damage so as to endanger any persons or property on or near the structure.

3.2 The carrying capacity shall normally be assessed relative to the loading possible from any convoy of vehicles of up to 40/44 tonnes gross vehicle weight. Where this loading cannot be carried an assessment should be undertaken for the loading that is representative of the full range of vehicles up to 38 tonnes gross vehicle weight permitted under the current Construction and Use Regulations. If the structure is still considered inadequate to carry this lesser load, a reduction in the number of lanes and/or in the level of loading should be determined. Overall structural behaviour must be considered since weakness in any part such as the foundation, sub-structure or superstructure can affect the load carrying capacity of the structure.

3.3 The procedures given in this section shall not be used for the assessment of spandrel and dry-stone walls and they may also not be appropriate for the assessment of other types of retaining walls, wing walls, sub-structures and foundations when their assessments are to be based on qualitative judgement of the information obtained from their inspections. For those assessments the requirements of Chapter 8 shall apply. However, the procedures in this section shall be employed when an analytical approach is considered to be needed and applicable to the structure in question. Further advice is given in BA 55 (DMRB 3.4.9).

Limit States

3.4 In general, structures shall be assessed by the application of limit state principles. The limit state to be adopted for this Standard shall be the ultimate limit state, using appropriate partial factors. However, for masonry arch bridges and cast iron bridges alternative assessment methods may be adopted in accordance with 3.5 or 3.6. In general, older structures do not need to be assessed for the serviceability limit state. However structures built after 1965 should normally be checked for the serviceability limit state as well as the ultimate limit state, but the need for this additional requirement shall be agreed by the Technical Approval Authority.

Masonry Arch Bridges

3.5 Limit state requirements are applicable to the assessment of masonry arch bridges. However, unless a suitable rigorous method of analysis is used conforming to the principles of Chapter 6, arches shall be assessed by the modified MEXE method in accordance with BA 16 (DMRB 3.4.4). The modified MEXE method determines allowable axle and bogie loads directly and is not in limit state terms. Therefore calculation of assessment load effects and assessment resistance in accordance with 3.7 to 3.19 is not required.

Cast Iron Bridges

3.6 Cast iron bridges shall be assessed on a permissible stress basis in accordance with 3.7 to 3.19, using special partial factors, and restricting stress levels to values which would exclude the risk of fatigue failure.

Assessment Load Values

Assessment Loads

3.7 The assessment loads, Q_A^* , are determined from the nominal loads, Q_K , according to the equation:

$$Q_A^* = \gamma_{fL} \cdot Q_K$$

where γ_{fL} is a partial factor for each type of loading as given in Table 3.1.

Nominal dead, superimposed dead and live loads are given in Chapter 5.

3.8 The Type HA loading given in Chapter 5 is factored to give the 40 tonnes Assessment Live Loading. Assessment calculations may need to be

Loading		γ_{FL}	
		Cast Iron Bridges	Other Structures
Dead *	cast iron	1.0	1.10
	steel, wrought iron	1.0	1.05
	concrete, stone and brick masonry, timber	1.0	1.15
Superimposed Dead +	surfacing material #	1.5 #	1.75 #
	filling, other make-up material, spandrel walls service, parapets and street furniture	1.0	1.20
Live		1.0	1.5

Table 3.1 Values of γ_{FL} - Partial Factor for Loads

Notes:
individual appropriate.

For masonry arch bridges, with respect to permissible single axle loads γ_{FL} shall be 3.4. For vehicles of precisely known configurations, a reduced γ_{FL} of 2.0 may be considered

effect had

* When the application of γ_{FL} for dead and superimposed dead load causes a less severe total than would be the case if γ_{FL} applied to all parts of the dead and superimposed dead loads, been taken as 1.0, values of 1.0 shall be adopted.

The top 100mm of road construction shall be considered as surfacing material.

+ For cast iron bridges the value of 1.5 may be reduced to 1.0 and for other structures the value of 1.75 may be reduced to 1.20, if the highway authority can ensure that the thickness of road surfacing is not increased during the remaining life of the bridge.

repeated with other levels of Assessment Live Loading (see 3.1 to 3.3, 3.20 to 3.25, Chapter 5 and Chapter 9).

Chapter 5 also includes live load requirements for a single wheel load, a single axle load and footway loading. For bridges carrying a horizontally curved carriageway, requirements are given for determining the enhancement in vertical live loading caused by centrifugal effects. Other loads not specified in this document shall only be considered when deemed necessary for assessment purposes. Assessment for these other loads shall be in accordance with the requirements of BD 37 (DMRB 1.3)

Load Combinations

3.9 Dead and superimposed dead loads shall be combined with live loads using the factors given in 3.7.

When other loads (not specified in this document or mentioned in Table 3.1) are considered to be significant for assessment purposes, reference shall be made to BD 37 (DMRB 1.3) for the details of these loads, appropriate load combinations and respective γ_{FL} values (except that for cast iron bridges the value of γ_{FL} shall be taken as 1.0).

Assessment Load Effects

3.10 The assessment load effects, S_A^* , are obtained from the assessment loads by the relation:

$$S_A^* = \gamma_{f3} (\text{effects of } Q_A^*) \\ = \gamma_{f3} (\text{effects of } \gamma_{FL} \cdot Q_K)$$

where γ_{f3} is a factor that takes account of inaccurate assessment of the effects of loading such as unforeseen

stress distribution in the structure, inherent inaccuracies in the calculation model, and variations in the dimensional accuracy from measured values. The effects of the assessment loads are to be obtained by the use of the appropriate form of analysis in accordance with the requirements of Chapter 6. For the purpose of this Standard the value of γ_{f3} shall be taken as 1.1, except that for cast iron bridges γ_{f3} shall be taken as 1.0.

Assessment of Resistance

Assessment Resistance

3.11 The assessment resistance, R_A^* , shall be determined from the calculated resistance, R^* , multiplied when required, by the overall condition factor, F_c , as follows:

$$R_A^* = F_c \cdot R^*$$

R^* and F_c should be determined in accordance with 3.12 to 3.17 and 3.18 and 3.19 respectively.

Calculated Resistance

Material		γ_m
Steelwork		1.05* to 1.30*
Wrought Iron		1.20
Concrete	Concrete	1.50
	Reinforcement Steel/ Prestressing Tendons	1.15
Brick and Stone Masonry		Varies #

Table 3.2 Values of γ_m - Partial Factor for Material Strength

* See Table 2 of BD 56 (DMRB 3.4) for the value to be taken for different components.

To be determined for the structure being assessed (see Chapter 4).

$$R^* = \frac{1}{\gamma_m} \text{function}(f_k)$$

3.15 For cast iron the calculated resistance shall be determined on a permissible stress basis from the following expression:

$$R^* = \text{function}(f_p)$$

where f_p is the permissible stress of cast iron as given in Chapter 4.

3.16 The strength of the sections shall be determined in accordance with the requirements of Chapter 7.

3.17 Wherever possible, the existing sound thickness (eg allowing for corrosion and cracking of the critical

3.12 The calculated resistance, R^* determined from material strengths and measured section properties shall be calculated from the following expression:

$$R^* = \text{function}(f_k/\gamma_m)$$

where f_k is the characteristic (or nominal) strength of the material as given in Chapter 4 and γ_m is a partial factor for material strength as given in Table 3.2.

3.13 BD 44 (DMRB 3.4) shall be used for the assessment of concrete structures. BD 56 (DMRB 3.4) and BA56 (DMRB 3.4) shall be used for the assessment of steel structures. BD61 (DMRB 3.4) and BA 61 (DMRB 3.4) shall be used for the assessment of composite structures.

3.14 For steel and wrought iron construction the expression may be modified as:

components) shall be measured, and used in determining R^* .

Condition Factor

3.18 If the measurement of sound thickness is not possible, or if there are other uncertainties in the determination of resistance, a condition factor F_{cm} shall be estimated to account for any deficiencies that are noted in the inspection (see Chapter 2), but cannot be allowed for in the determination of calculated resistance R^* . The value of F_{cm} shall represent, on the basis of engineering judgement, an estimate of any deficiency in the integrity of the structure. This may relate to a member, a part of the structure or the structure as a whole. The value taken for F_{cm} shall not be greater than 1.0.

3.19 Advice on determining suitable condition factors for use with the modified MEXE method for masonry arches is given in BA 16 (DMRB 3.4). These condition factors shall also be used with other arch analysis methods unless other similar rationally-derived factors are available.

Verification of Structural Adequacy

3.20 Structures shall be deemed to be capable of carrying the assessment load when the following relationship is satisfied:

$$R_A^* \geq S_A^* \tag{Equation 1}$$

ie

$$F_c \cdot function \frac{f_k}{\gamma_m} \geq \gamma_{f\beta} (effects\ of\ \gamma_{fL} \cdot Q_k) \tag{Equation 2a}$$

Note: Superscript * refers to factored values.

3.21 For steel and wrought iron construction the relationship may be rearranged as follows:

$$\frac{F_c}{\gamma_{f\beta} \gamma_m} \cdot function (f_k) \geq (effects\ of\ \gamma_{fL} \cdot Q_k) \tag{Equation 2b}$$

3.22 For cast iron the following relationship shall be satisfied:

$$F_c \cdot function (f_p) \geq (effects\ of\ \gamma_{fL} \cdot Q_k) \tag{Equation 2c}$$

3.23 In this Standard reference is made to the use of Parts 3, 4 and 5 of BS 5400 as implemented by BD 56 (DMRB 3.4), BD 44 (DMRB 3.4) and BD 61 (DMRB 3.4) respectively. When using these documents care shall be taken to ensure that the partial factors of safety are correctly applied.

*Note: Except for the additional factor F_c , the format of equation 2a is used in BD 44 (DMRB 3.4) whereas the format given in equation 2b is used in BD 56 (DMRB 3.4). Therefore when using BD 61 (DMRB 3.4) in conjunction with either BD 56 (DMRB 3.4) or BD 44 (DMRB 3.4) care must be taken to ensure that $\gamma_{f\beta}$ is applied correctly.

3.24 If equation 2a, 2b or 2c is not satisfied, consideration shall be given to weight and/or lane restrictions and repair, strengthening or reconstruction of the structure as appropriate (see Chapter 1). Assessment for various levels of Assessment Live Loading, (see 5.12 to 5.18) shall be determined by deriving appropriate reductions to the value of Q_k in accordance with Chapter 5 and substituting the values in equations 2a, 2b or 2c.

3.25 The modified MEXE method for the assessment of masonry arches determines the values for allowable axle or bogie loads which can be compared to the live loading given in Appendix A, thereby enabling the structural adequacy to be verified directly for 40 tonne vehicles and full C&U loading. Alternatively, the axle or bogie loads allowable for the arch enable gross vehicle weight restrictions to be determined.

Fatigue Assessment

3.26 Requirements for fatigue endurance are not included in this Standard because any such assessment would be profoundly influenced by the past stress history of each structure, which cannot generally be determined to the accuracy required for assessment purposes. Reference shall be made to the appropriate provisions of Part 10 of BS 5400 as implemented by BD 9 (DMRB 1.3), when fatigue endurance calculations are considered necessary for the assessment of a structure.

Fatigue endurance calculations are not required for cast iron structures, because the level of stress permitted in this Standard provides a reasonable assurance against fatigue failure.

3.27 BA 38 (DMRB 3.4) deals specifically with the fatigue of corroded reinforcement.

Load Testing

3.28 Load testing is not generally warranted for the assessment of structures because of the high costs involved, the possibility of causing structural damage while undertaking the tests and the difficulty in interpreting any test results. Consideration for testing shall only be given to those structures whose structural behaviour is uncertain or where the material strength at critical sections needs to be considered. It should be noted that load testing on its own is not sufficient to assess directly the capacity of a structure to resist with adequate margins of safety the various loading conditions to which it may be subjected during its life. Load tests should therefore be complementary to the analytical process and are not to be considered as a replacement for the usual assessment procedures. Further guidance is given in BA 54 (DMRB 3.4).

3.29 The object of load testing shall be to check structural behaviour under load and/or verify the method of analysis being used, ie to prove the accuracy and suitability of the assessment model of the structure. This will require the structure to be adequately instrumented for any test and for sufficient number of measurements to be taken to allow the assessment model to be properly verified. The assessment model shall be adjusted if necessary in the light of the test results and the refined model used to determine the load capacity of the structure in accordance with the requirements of this Standard.

4. PROPERTIES OF MATERIALS

Unit Weights, Elastic Moduli and Coefficients of Expansion

4.1 It is recommended that, for initial assessment, the appropriate values of the material properties given in Tables 4.1, 4.2 and 4.3 should be used. However, in cases where the initial assessment shows inadequacies or there is doubt about the particular material, the material properties should be verified by testing. Table 4.1 gives the unit weights of materials, Table 4.2 gives elastic moduli and Table 4.3 gives coefficients of linear thermal expansion.

Strengths of Materials

General

4.2 For initial assessment the characteristic strengths of materials should be taken as specified in 4.3 to 4.10. Testing should normally only be carried out if the initial assessment is considered inadequate or if there is some doubt about the nature and quality of the materials. The strength values obtained from a limited number of tests shall be considered as only an indication of whether the characteristic strength values in 4.3 to 4.10 are applicable to the material present in the structure. For any particular structure the determination of appropriate characteristic strength values that are statistically valid will usually require extensive testing. Special requirements for the testing of wrought iron are given in 4.9. The strength of materials in a particular structure may be known from records. In the cases of stone and wrought iron it is often useful to know their source.

Steel

4.3 In general, the nominal yield stress for steel shall be determined as described in BD 56 (DMRB 3.4). In the absence of definite information a characteristic yield strength of 230 N/mm² may be assumed for steel produced before 1955. Some of the pre-1922 steels were of poor quality and should be closely inspected for laminations, inclusions and deformities. Since about 1955, steel has been available in various grades, ie with different levels of yield stresses. Hence, it is essential to identify the particular grade and specification of the steel on the structure from available documents. From this information, and reference to the specification, it should be possible to determine the yield stress that can be used for assessment. A table of minimum yield

stresses specified in various post-1955 British Standard Specifications is given in Appendix C. When information from documents is not available, hardness measurements and/or sample testing shall be undertaken. The method given in BS 427 may be used for the hardness test.

Reinforcement

4.4 Pre-1961 reinforcement may be assumed to have a characteristic strength not greater than 230 N/mm². For reinforcement after this date, the strength shall be taken as specified in the appropriate design codes of the period for high yield and mild steel bars.

4.5 Corrosion or damage can reduce the strength and ductility of reinforcement. For tensile reinforcement, where the loss of cross sectional area is less than approximately 50%, the design characteristic strength and an adequate ductility can be assumed in assessing the strength of a member. Where the loss exceeds approximately 50%, an appropriate value of the strength and the degree of ductility of the reinforcement shall be based on test evidence.

Prestressing Tendons

4.6 The characteristic strength of prestressing tendons was first specified by the British Standards Institution in 1955. Values for tendons used before this date may be taken from documents of the period (Ref 9).

Concrete

4.7 Pre-1939 concrete may be assumed to have a characteristic strength not greater than 15 N/mm². The strength of modern concrete shall be taken as specified in BD 44 (DMRB 3.4). Where concrete strength has been defined in terms of a 28 day minimum cube strength, this should be considered as being equal to the characteristic cube strength.

4.8 Guidance on the assessment of concrete strength in existing structures from tests on samples is given in BS 6089 : 1981.

Material #		Unit Weights kg/m ³
Metal	Aluminium	2750
	Cast Iron	7200
	Wrought Iron	7700
	Steel	7850
Concrete	Reinforced	2400
	Plain	2300
	Breeze	1400
Masonry	Engineering Bricks	2400
	Other Solid Bricks	2100
	Granite	2600 to 2930
	Sandstone	2200 to 2400
Timber *	Yellow Pine	480
	Red Pine, Spruce	480 to 720
	English Oak	720 to 960
	Larch, Elm	560
	Pitch Pine	640 to 720
	Teak	640 to 880
	Jarrah	960
	Greenheart	1040 to 1200
Bituminous	Macadam (tar)	2400
	Macadam (waterbound)	2560
	Asphalt	2300
Fill	Sand (dry)	1600
	Sand (saturated)	2000
	Ballast, gravel (loose)	1600
	Ballast, gravel (saturated)	2100
	Hardcore	1920
	Crushed slag	1440
	Packed stone rubble	2240
	Earth (dry, compact)	1600
	Earth (moist, compact)	1800
	Puddled clay	1920
	Miscellaneous	2200

Table 4.1 Unit Weights of Materials

Reference may be made to BS 648 (Schedule of Weights of Building Materials) for the unit weights of materials not listed.

* Wide range of unit weights because of the variability of timber.

Material*	Modulus of Elasticity E N/mm ²
Cast Iron	90,000 to 138,000
Wrought Iron	200,000
Steel (including pre-1992 steel)	205,000
Concrete:	
Long Term Loading (generally accepted value # for 1918-1939 concrete)	14,000
Short Term Loading	See BD 44 (DMRB 3.4)
Reinforcement Steel	200,000
Prestressing Tendons	See BD 44 (DMRB 3.4)

Table 4.2 Elastic Moduli

- * For modern materials see the relevant Standards for implementation of BS 5400 or, where available, the relevant assessment versions.
- # Value of E depends upon age, cement content and other factors.

Material	Coefficient of Linear Thermal Expansion per degree Centigrade
Aluminium	25.5 x 10 ⁻⁶
Cast Iron	10.2 x 10 ⁻⁶
Wrought Iron	12.0 x 10 ⁻⁶
Mild Steel	12.0 x 10 ⁻⁶
Masonry	4 to 7 x 10 ⁻⁶
Timber (along the grain)	3 to 5 x 10 ⁻⁶
Concrete* (increases with cement content)	9 to 14 x 10 ⁻⁶
Concrete* made with aggregates listed below	
Chert	13.5 x 10 ⁻⁶
Quartzite	12.0 x 10 ⁻⁶
Sandstone, Quartz, Glacial Gravel	11.5 x 10 ⁻⁶
Siliceous Limestone	11.0 x 10 ⁻⁶
Granite, Dolerite, Basalt	10.0 x 10 ⁻⁶
Limestone	9.0 x 10 ⁻⁶

Table 4.3 Coefficients of Linear Thermal Expansion

- * For the purpose of calculating temperature effects, the coefficient of linear thermal expansion for structural steel and for concrete may generally be taken as 12 x 10⁻⁶ /°C. If the type of aggregate is known, the calculated temperature effects may be calculated using the coefficients of linear thermal expansion as given

in Table 4.3 above. The values given contain an allowance for the presence of reinforcement.

Wrought Iron

4.9 The quality of wrought iron may depend upon where and when it was made and its strength can vary considerably. It should always be carefully examined for laminations, inclusions and deformities. As a general guide the characteristic yield stress may be taken as 220 N/mm² for wrought iron of satisfactory quality; however testing is required when defects are present. If tests are carried out, the characteristic yield stress should be determined as described in Appendix C.

Cast Iron - Compressive and Tensile Stresses

4.10 The compressive stress in cast iron due either to the permanent load or to the combined permanent and live load shall not exceed 154 N/mm². The tensile stress due either to the permanent load or to the combined permanent and live load shall not exceed 46 N/mm². In addition, for a given value of permanent load stress, the live load stress shall not exceed the permissible tensile or compressive live load stresses obtained from Figure 4.1.

* Note: The values of the permissible live load stress given in Figure 4.1 are based on the 154N/mm² compressive stress and the 46N/mm² tensile stress limitations and the additional restriction that the live load stress, f_L , shall not exceed the values given by the following:

- (i) For tensile values of f_L , the greater of the values given by

$$\text{either } f_L = 24.6 - 0.44 f_d \text{ N/mm}^2$$

$$\text{or } f_L = 19.6 - 0.76 f_d \text{ N/mm}^2$$

- (ii) For compressive values of f_L , the greater of the values given by

$$\text{either } f_L = -43.9 + 0.79 f_d \text{ N/mm}^2$$

$$\text{or } f_L = -81.3 + 3.15 f_d \text{ N/mm}^2$$

Where f_d is the permanent load stress and tensile stresses are positive.

Cast Iron - Shear Stresses

4.11 The shear stress in cast iron due either to the

permanent load or to the combined permanent and live load shall not exceed 46 N/mm². In addition the following limitations shall apply:

- (i) where the live load shear stress q_L acts in the same sense as the dead load shear stress q_d

$$q_L \leq 24.6 - 0.44 q_d \text{ N/mm}^2$$
- (ii) where the live load shear stress q_L acts in an opposite sense to the dead load shear stress q_d
 - (a) $q_L \leq 43.9 - 0.79 q_d \text{ N/mm}^2$ when $q_L \leq 2q_d$
 - (b) $q_L \leq 24.6 + 0.44 q_d \text{ N/mm}^2$ when $q_L > 2q_d$

In the above inequalities, the signs of the shears have been taken into account and only numerical values of q_L and q_d should be substituted.

Masonry

4.12 Graphs for brick and stone in Figures 4.2 and 4.3 respectively give an indication of the order of strength to be expected for various types of masonry according to the units and mortar. These values may be used for an initial assessment with rigorous forms of analysis. Where strength tests are carried out it is preferable to do them on masonry built with the same units and mortar rather than on the units and mortar separately. TRRL Contractor Report 244 'Masonry Properties for Assessing Arch Bridges' (Ref 10) and BS 5628 'Structural Use of Masonry' give information on suitable tests and strengths.

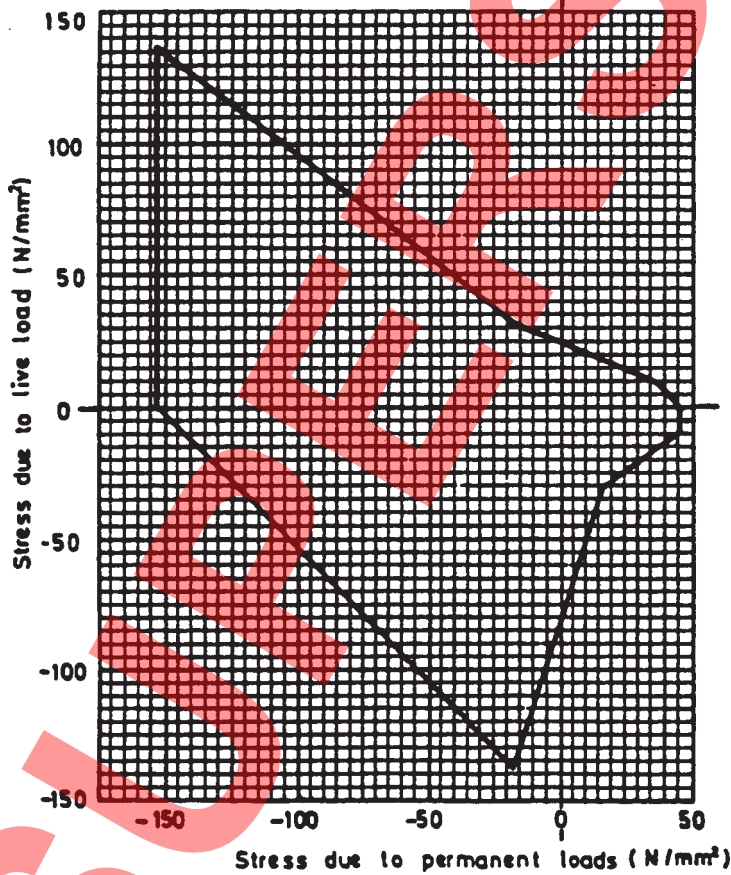
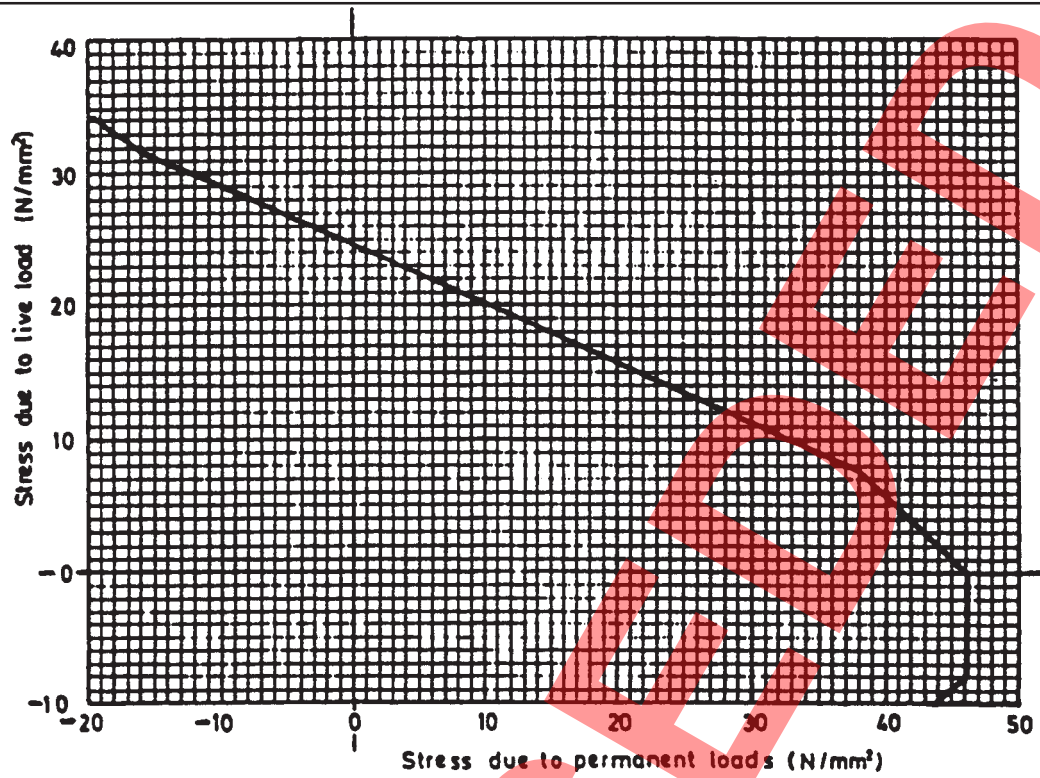

Figure 4.1 Permissible Stresses in Cast Iron

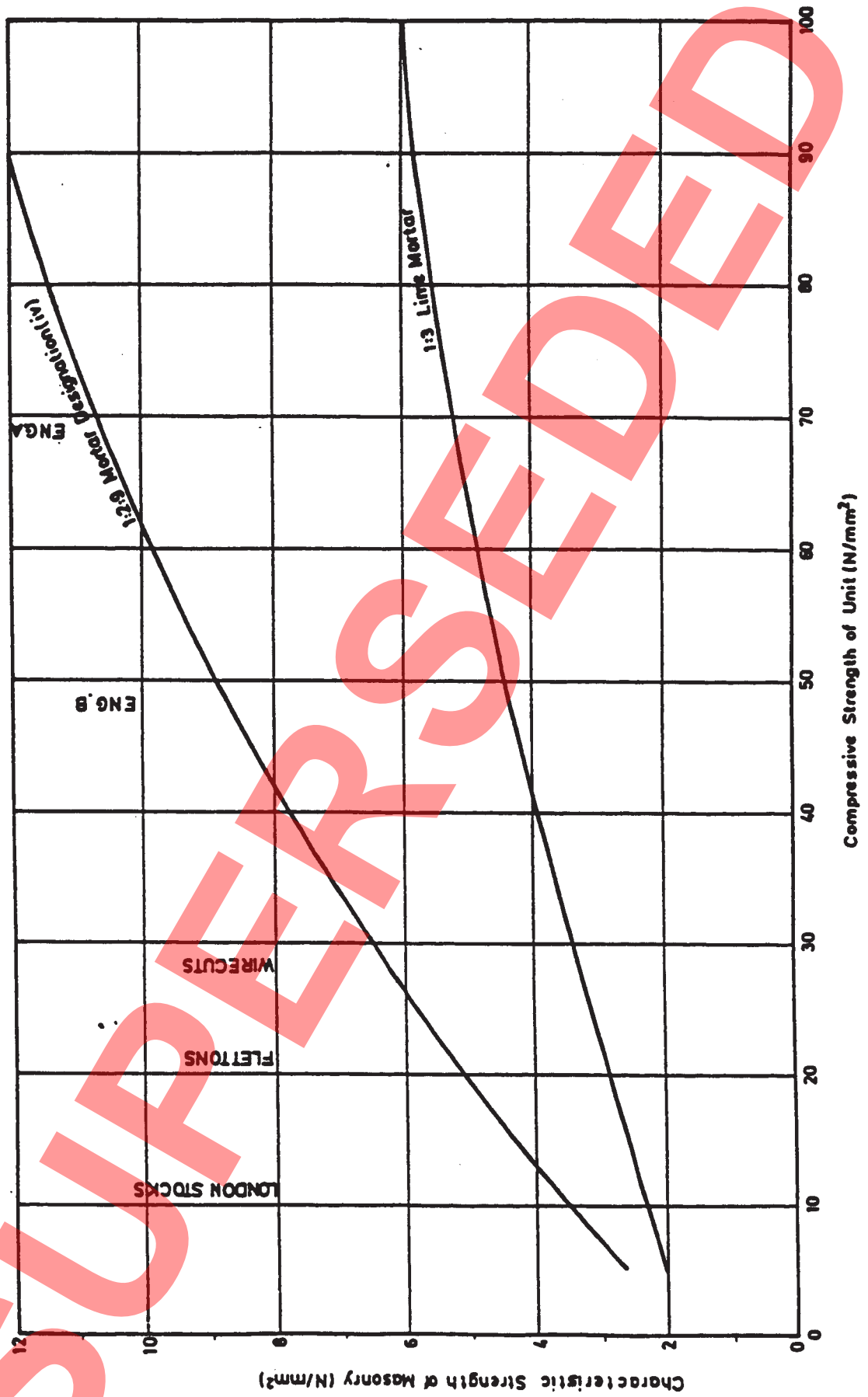

Figure 4.2 Characteristic Strength of Normal Brick Masonry

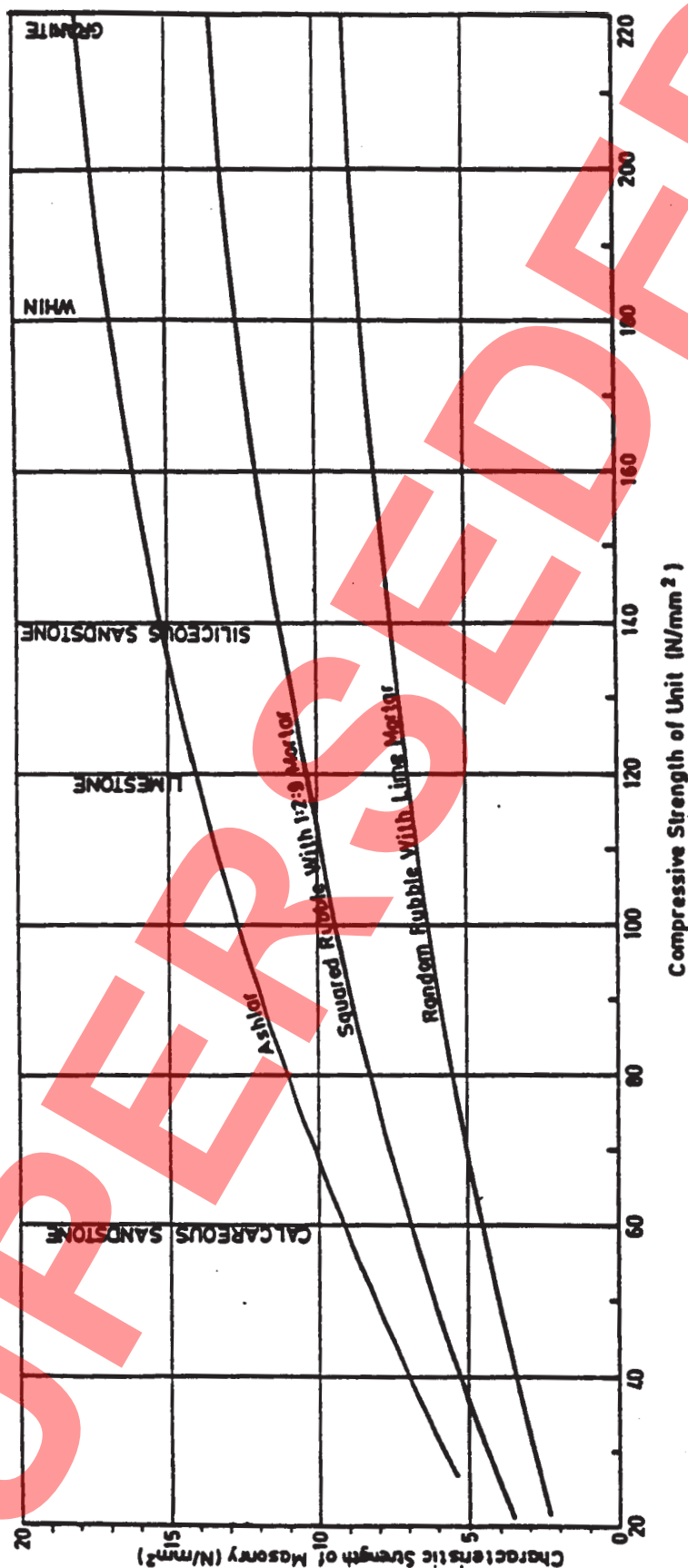

Figure 4.3 Characteristic Strength of Normal Stone Masonry

5. LOADING

General

5.1 Structures shall be assessed to the loading requirements given in this Chapter. Assessment loading will generally be limited to the application of dead and superimposed dead loads and type HA live loads, the latter consisting of a uniformly distributed load (UDL) together with a knife edge load (KEL), as specified in 5.8 to 5.28. Type HA loading is given in Table 5.2 and Figure 5.1. For assessment purposes this is factored to give the Assessment Live Loading. Type HB loading need not be applied for assessment purposes. Live load requirements are also included for a single wheel load, single axle load, accidental wheel loading, and footway loading. All loads specified in this Section are nominal loads and shall be multiplied by the appropriate partial factors given in Chapter 3.

5.2 The type HA, UDL and KEL does not satisfactorily model the effect of vehicles on trough decks, short span masonry arches, decks with main members that span transversely and buried concrete box type structures with cover greater than 0.6m. These types of structure shall be assessed using the loads given in 6.9 to 6.14 for troughing, 6.15 to 6.29 for masonry arches and Appendices D and E for girders and slabs that span transversely and buried concrete box type structures with cover greater than 0.6m.

5.3 When loading or principal combinations of loads other than those specified in this Standard are considered necessary for assessment purposes, these loadings shall comply with the requirements given in BD 37 (DMRB 1.3). Further advice on the application of such loads is given in BA 34 (DMRB 3.4).

5.4 Requirements are given for Assessment Live Loading to enable bridges to be assessed for their capacity to carry either 40/44 tonne vehicles or the full range of vehicles possible under C&U Regulations or for restricted traffic (see Chapter 9).

5.5 When the carriageway on the bridge is horizontally curved, the structure shall be assessed for the live loading requirements given in 5.8 to 5.28 and, in addition, a separate assessment for centrifugal effects may be required in accordance with the requirements of 5.39 to 5.46.

Notional Lane and Live Loading Application

Notional Lane Widths (b_L)

5.6 For the purposes of applying the Assessment Live Loadings, the carriageway* shall be divided into a number of notional lanes. The lane widths shall be neither less than 2.5m nor greater than 3.65m where the number of notional lanes exceed 2. The number of notional lanes shall be based on the actual lane markings. If the marked lanes are greater than 3.65m wide then the criteria given in Table 5.1 shall be used to determine the number of notional lanes. A hard shoulder shall be considered as a traffic lane. If there are no lane markings, the carriageway shall be divided into the integral number of notional lanes having equal widths as given in Table 5.1. Each notional lane shall be loaded with the appropriate UDL and KEL.

*Note: The carriageway width shall be considered as the width of running surface between kerbs, raised paving, barriers, etc. Where the running surface is divided by a physical obstruction (eg, a dual carriageway with central reserve) two separate carriageway widths shall be considered.

Carriageway Width (m)	Number of Notional Lanes
below 5.0	1
from 5.0 up to and including 7.5	2
above 7.5 up to and including 10.95	3
above 10.95 up to and including 14.6	4
above 14.6 up to and including 18.25	5
above 18.25 up to and including 21.9	6

Table 5.1 Number of Notional Lanes

Nominal Dead Load

5.7 The nominal dead load and nominal superimposed dead load shall be derived having regard to 4.1.

Nominal Assessment Live Loads

General

5.8 The Assessment Live Loading levels of loading cover the ranges of vehicles specified in 5.12 to 5.18. For loaded lengths of 2m to 50m the following loads shall be applied:

- (i) A UDL (which varies with loaded length) together with a KEL;
- (ii) A single axle load;
- (iii) A single wheel load.

All members of the structure shall be capable of sustaining the worst effects resulting from the separate application of these loads.

5.9 For loaded lengths less than 2m the single axle load and the single wheel load shall be used. For loaded lengths in excess of 50m, the UDL and KEL to be used shall be as described in BD 50 (DMRB 3.4.2).

5.10 Values are given for single axle and single wheel loads in Tables 5.3.1 and 5.3.2 that are applicable to the Assessment Live Loading levels of loading. However, values for the UDL and KEL are only given for the type HA loading case because the Reduction Factors given in 5.22 to 5.29 make it possible to determine Assessment Live Loading effects directly from the previously calculated effects of type HA loading.

5.11 Requirements for accidental wheel loading, footway loading and for the assessment of centrifugal effects are given in 5.35, 5.36 and 5.37 to 5.45 respectively.

Assessment Live Loadings

5.12 40 tonnes Assessment Live Loading. This covers the full range of vehicles up to 40/44 tonnes gross weight (See Appendix A). It does not cover the passage of Special Types General Order Vehicles as regulated by Statutory Instruments 1979 No 1198 and 1987 No 1327 and in Northern Ireland by the Motor Vehicles (Authorisation of Special Types) General Order (Northern Ireland) 1968 (S.R. & O. 1968 No 277), the Motor Vehicles (Authorisation of Special Types) (Amendment) Order (Northern Ireland) 1988 and the Motor Vehicles (Authorisation of Special Types) (Amendment) Order (Northern Ireland) 1991, (except for those described in 5.15) or Special Order Vehicles.

5.13 38 tonnes Assessment Live Loading. This covers the full range of vehicles possible under the current C&U Regulations (See Appendix A). It also covers Special Types General Order (STGO) Category 1 vehicles which can have gross vehicle weights (GVWs) of up to 46 tonnes. It should be noted that STGO Category 2 vehicles can also have GVWs lower than 46 tonnes but are not covered by this loading. It also does not cover Engineering Plant as defined in Statutory Instrument No. 1198 (1979) and in Northern Ireland by S.R. & O.1968 No 277, even if the total weight is 38 tonnes or less except when such plant is being transported on a STGO Category 1 vehicle.

5.14 25 tonnes Assessment Live Loading. This loading corresponds to the loading imposed by all types of two or three axle C&U and public service vehicles (restricted to 25 tonnes gross weight).

5.15 17 tonnes Assessment Live Loading. This loading corresponds to the loading imposed by all types of two axle C&U and public service vehicles (restricted to 17 tonnes gross weight).

5.16 7.5 tonnes Assessment Live Loading. This loading corresponds to the loading imposed by two axle light goods vehicles and public service vehicles (restricted to 7.5 tonnes gross weight).

5.17 Fire Engine Loading. These loadings correspond to two groups of fire engines (FE). Details of the vehicles included in each group are listed in Appendix E. This loading allows for up to three permitted vehicles in convoy.

5.18 3 tonnes Assessment Live Loading. This loading corresponds to the loading that is imposed by cars and vans (restricted to 3 tonnes gross weight).

Type HA Loading UDL and KEL

5.19 For loaded lengths between 2m and 50m the type HA loading is represented by the UDL derived from the loading curve $W = 336 (1/L)^{0.67}$, where W is the UDL in kN per metre length of lane of width 3.65m (but for application see 5.20) and L is the loaded length in metres, applied in conjunction with a KEL of 120 kN uniformly distributed across the lane width. This loading curve is illustrated in Figure 5.1 and tabulated in Table 5.2. For loaded lengths greater than 50m refer to BD 50 (DMRB3.4.2). The longitudinal disposition of the KEL is to be such as to cause the most severe effect on the structural element under consideration. The

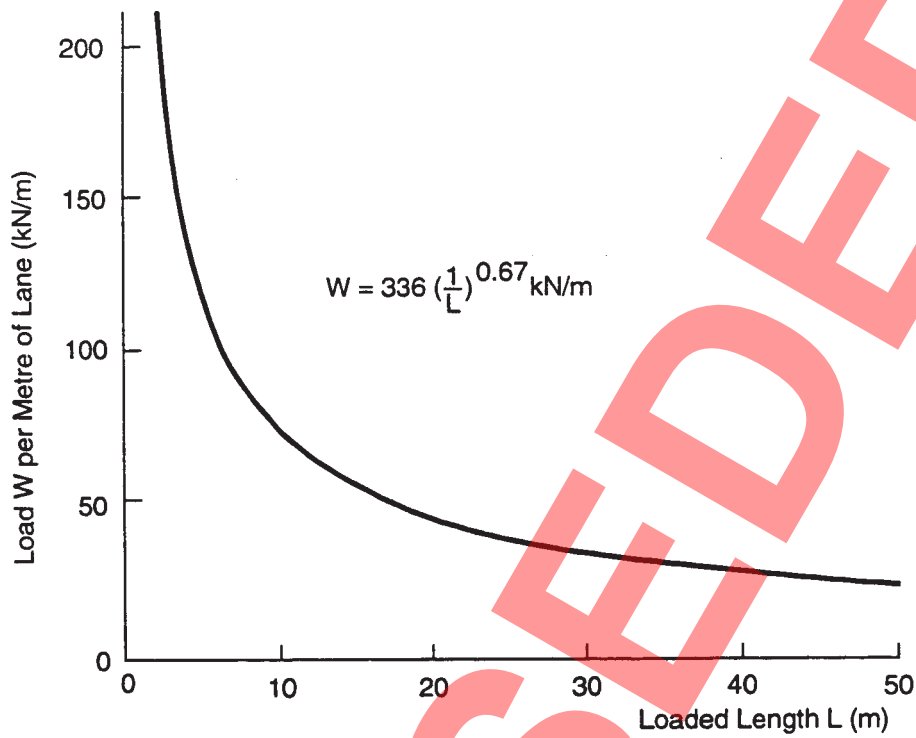

Figure 5.1 UDL Curve for Type HA Load

Loaded Length m	Load kN/m	Loaded Length m	Load kN/m
2	211.2	28	36.0
4	132.7	30	34.4
6	101.2	32	33.0
8	83.4	34	31.6
10	71.8	36	30.5
12	63.6	38	29.4
14	57.3	40	28.4
16	52.4	42	27.5
18	48.5	44	26.6
20	45.1	46	25.8
22	42.4	48	25.1
24	40.0	50	24.4
26	37.9		

Note: for the definition of loaded length see Standard BD 37 (DMRB 1.3).

Table 5.2 Type HA loading UDL for Loaded Lengths 2m to 50m

derivation of the short span type HA loading is given in Appendix G.

5.20 The UDL determined for the appropriate loaded length (see Note under Table 5.2) and the KEL loads shall be applied to each notional lane in the appropriate parts of the influence line for the element or member under consideration. The lane loadings specified in 5.7 are interchangeable between the notional lanes and the notional lane or lanes may be left unloaded if this causes the most severe effect on the member or element under consideration. The KEL shall be applied at one point only in the loaded length of each notional lane.

5.21 In general, type HA loading is suitable only for modelling of longitudinal load effects within the loaded lane. Where transverse load effects are to be considered the vehicles of the Appendices D and E shall be used.

Reduction Factors for UDL and KEL

5.22 The Reduction Factor K is defined as the ratio:

$$\text{Assessment Live Loading} / \text{Type HA Loading}$$

If a linear elastic method of analysis is used to determine the effects of loading, K will also be the ratio of Assessment Live Loading effects/Type HA loading effects. Both the UDL and the KEL parts of the type HA loading are reduced by an identical Reduction Factor for each of the Assessment Live Loadings, and hence the effects of Assessment Live Loading may be obtained directly from the type HA loading effects for UDL and KEL for loaded lengths in excess of 2m.

5.23 Type HA loading was derived by deterministic means, ie by estimating the worst credible values of relevant loading parameters from statistics available at the time. Recent data and probabilistic analyses indicate that the basic requirements can be relaxed for bridge situations less onerous than the above worst case scenario, while maintaining a consistent reliability level for the whole network. Relaxations have been produced by making the worst category of loading equivalent to the current assessment loading, and then determining the successive relaxation levels on the basis of constant reliability for bridges in all situations.

5.24 The research work referred to above justifies that there should be six separate loading requirements corresponding to six categories of bridge situations in

terms of road surface characteristics and daily traffic flow (both directions). The categories are as follows :

Traffic Flow*

Annual Average Hourly HGV Flow (AAHHGVF)

High (H)	AAHHGVF > 70
Medium (M)	70 > AAHHGVF > 7
Low (L)	7 > AAHHGVF

Road Surface Categories **

Good (g) Variances of the Moving Average Deviations of road surface over a length of road including the bridge and extending 5.0m beyond each end.

< 4.5mm² for gauge length 3m,

and < 30mm² for gauge length 10m,

and < 180mm² for gauge length 30m.

Poor (p) Other surface profiles, including when measurements are not available.

The 6 categories of bridges will be referred to as Hg, Mg, Lg, Hp, Mp and Lp.

* AAHHGVF is equal to the total annual 2-way HGV flow over the bridge divided by 8760. A sufficiently accurate approximation to the AAHHGVF may be obtained from the traffic counts over limited periods. TRL Report SR 802 provides guidance on interpretation of such data.

** Suitable procedures and equipment for measuring profiles and deriving variances are described in TRL Report LR 1125.

5.25 The HA UDL and KEL have been derived using a lateral bunching factor to take into account the possibility that, in slow moving situations, more lanes of traffic than the marked or notional lanes could use the bridge. Probabilistic analysis shows that maximum impact effects, which occur at high speeds, should not be considered together with maximum lateral bunching. Comparison of the effects of alternative traffic speed and bunching situations have led to the conclusion that

high speed high impact effect with no lateral bunching is the most onerous criterion for bridge loading. The HA UDL and KEL are therefore to be adjusted in order to eliminate the lateral bunching factor by **dividing by** the following Adjustment Factor (AF):

For $0 < L < 20$

$$AF = \bar{a} / 2.5$$

For $20 < L < 40$

$$AF = 1 + (\bar{a} / 2.5 - 1) \times (2 - L/20)$$

For $40 < L < 50$

$$AF = 1.$$

Where $\bar{a} = 3.65\text{m}$ and L is the loaded length (m).

5.26 The bridge specific live loading for the 40 tonnes assessment level, for each loaded length and notional lane, shall be determined by multiplying the **adjusted** (as described in Paragraph 5.25 above) HA UDL and KEL by the product of the appropriate Load Reduction Factor K , selected from the relevant figure (to be referred to henceforth as the 'appropriate K diagram') from Figures 5.2 to 5.7, which correspond to the six classes of bridge situations described above, and the Lane Factors which are as follows:

Lane 1:	1.0
Lane 2:	1.0
Lane 3:	0.5
Lane 4 and subsequent:	0.4

5.27 The lane loading for any lane determined as in 5.26 above shall be applied to occupy a width of 2.5m, in the most onerous transverse position in that lane. The remainder of any notional lane shall not be loaded with any live loading.

5.28. If the bridge is found to be inadequate for the 40t load level, the value of its live load capacity factor C shall be determined as defined below:

$$C = \frac{\text{Available live load capacity}}{\text{Live Load Capacity required for Adjusted HA Loading}}$$

The permissible weight restriction level shall be the highest for which the K value in the appropriate K

diagram is less than C . (Note: The 3 tonne and fire engine types FE1 and FE 2 loading models are not probabilistic, hence all 6 K diagrams contain the same K factors for these weight restriction levels.)

Recently Assessed Bridges

5.29 Bridges already assessed during the current Assessment and Strengthening Programme using BD 21/93, and found to be inadequate for the 40t load level, may be checked in respect of the above requirements using the following simplified procedure:

- (1) **Multiply** the value of the load reduction factor K from the previously carried out assessment by the Adjustment Factor AF given in 5.25, **except that \bar{a} shall be taken as b_L , notional lane width in metres.**
- (2) Determine the weight restriction level by comparing the product ($K \times AF$) with the values of K given in the appropriate K diagram.

5.30 The purpose of the above check is to determine approximately if for a particular bridge there is any likelihood of improving the already assessed capacity if the above requirements are used. If a bridge, when assessed using the simplified procedure, is found to have an improved load capacity, it will be worthwhile to carry out a new assessment using the above requirements. However, in certain circumstances for beam and slab type of bridges, the improvement may not be substantiated. If, when using the above simplified procedure, a bridge is found to be marginally inadequate for a particular load level, a full assessment using the above requirements may still be advisable, as the bridge may then be found to be adequate for that level.

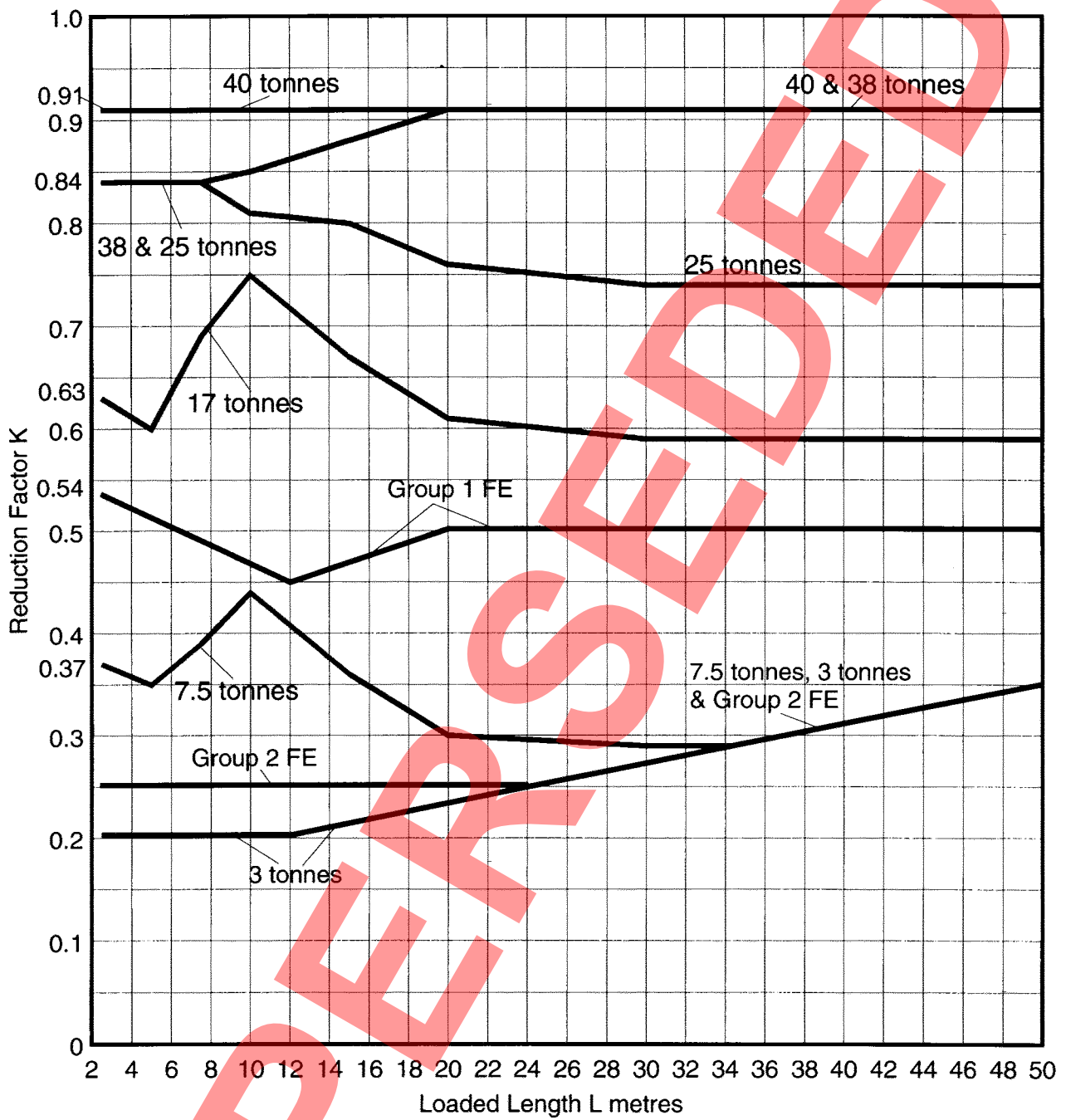

Figure 5.2 K Factors for Heavy Traffic Poor Surface (H_p)

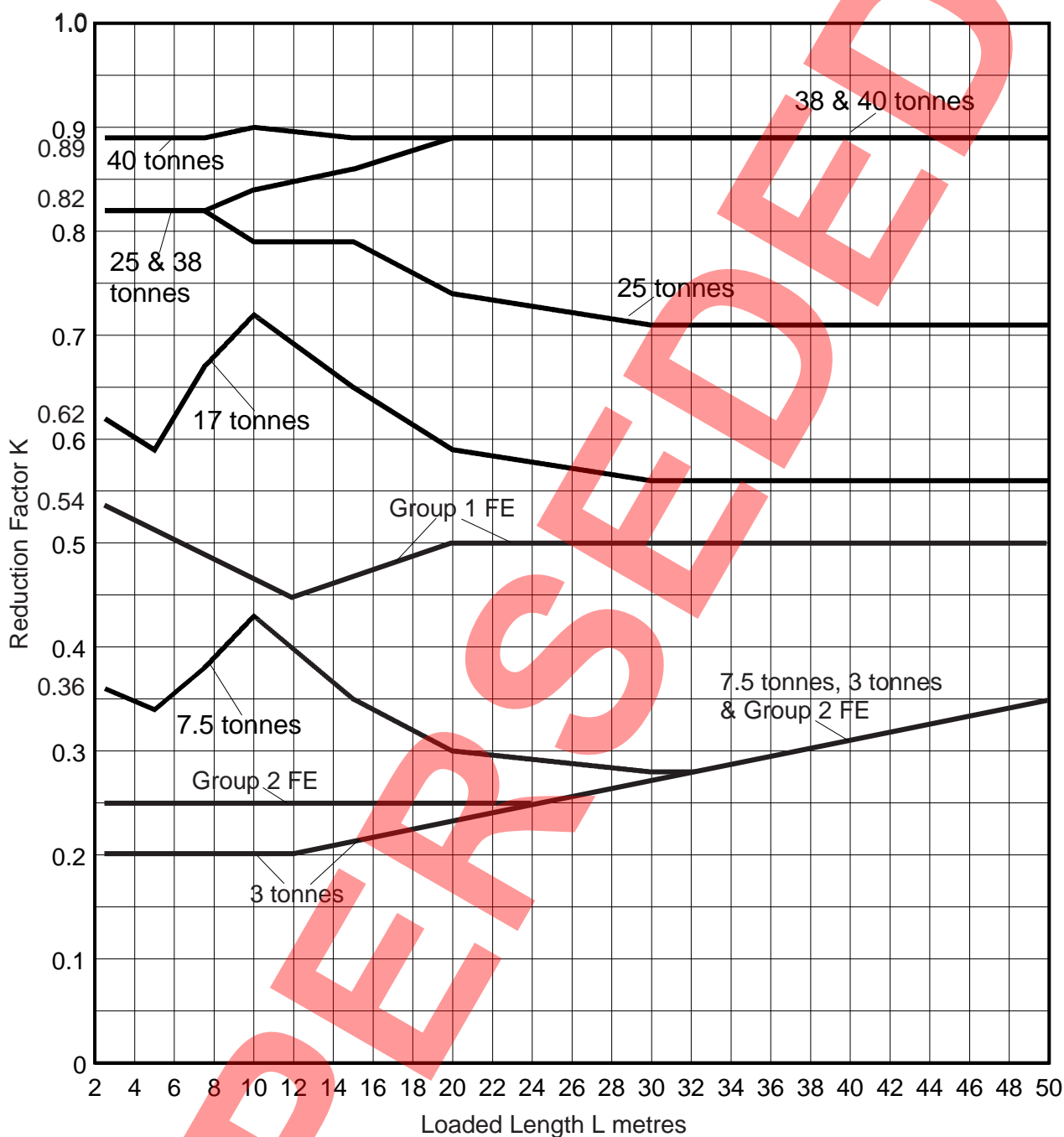

FIG 5/3. K Factors for Medium Traffic Poor Surface (Mp)

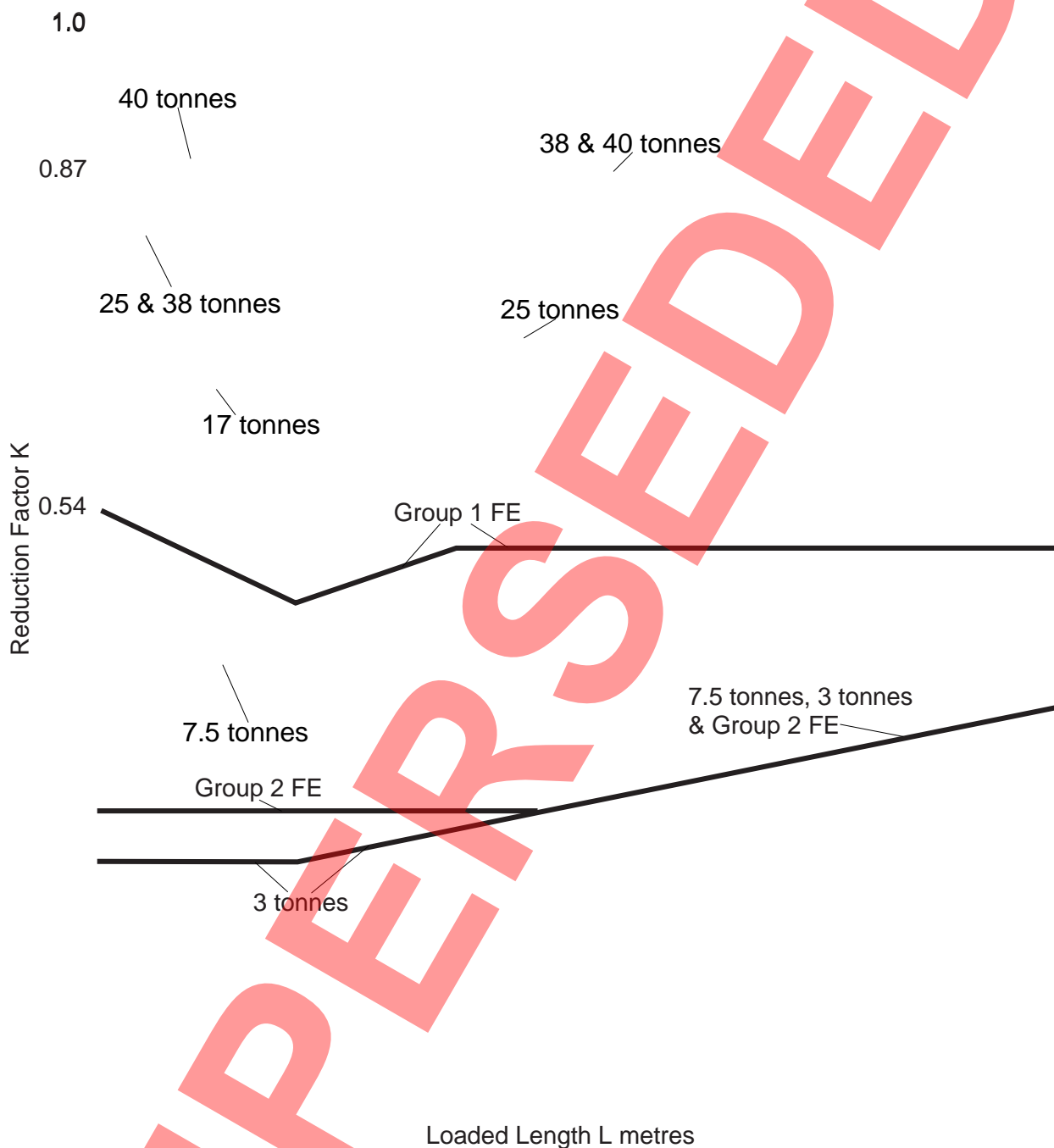

FIG 5/4. K Factors for Low Traffic Poor Surface (Lp)

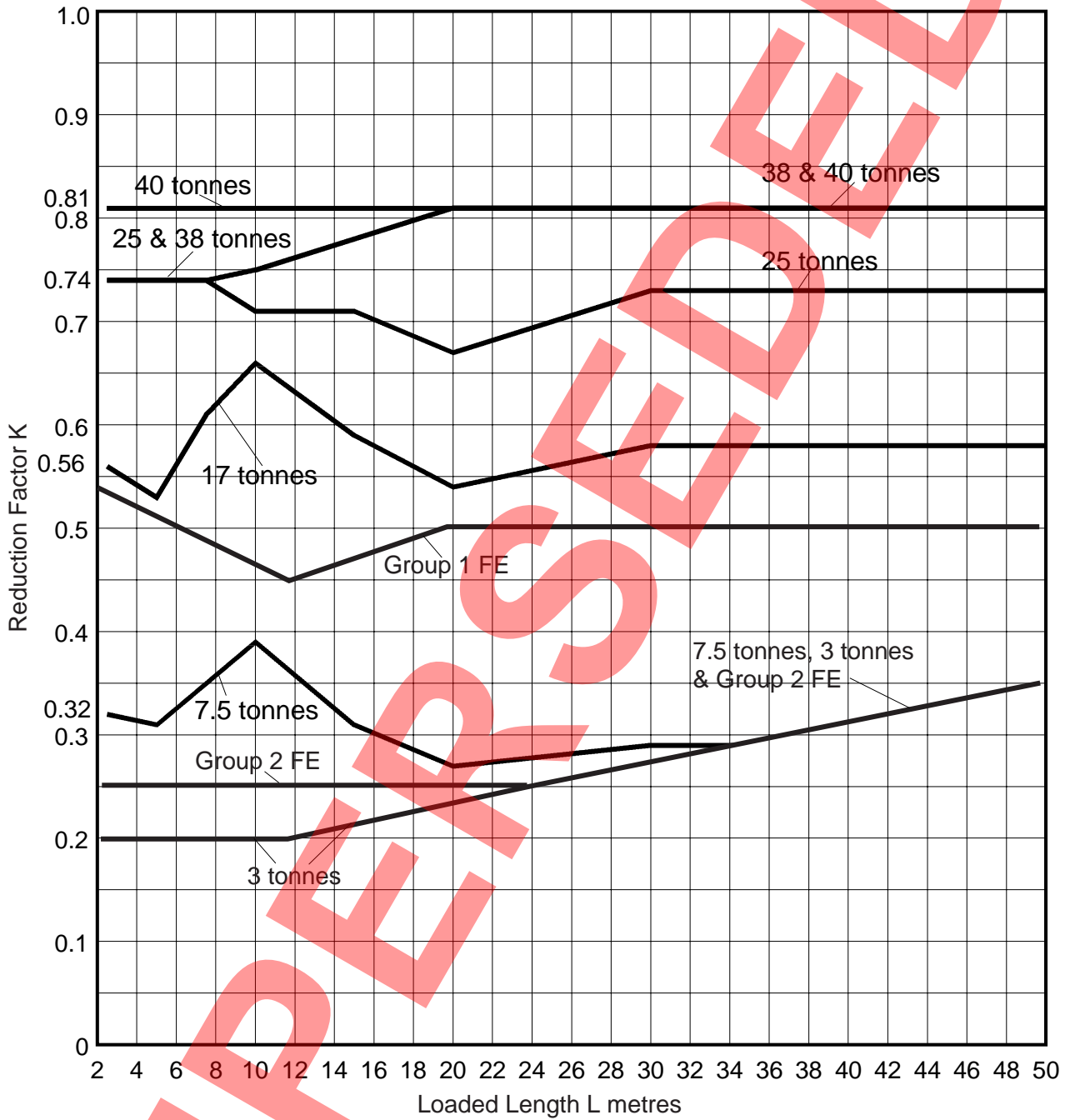

FIG 5/5. K Factors for Heavy Traffic Good Surface (Hg)

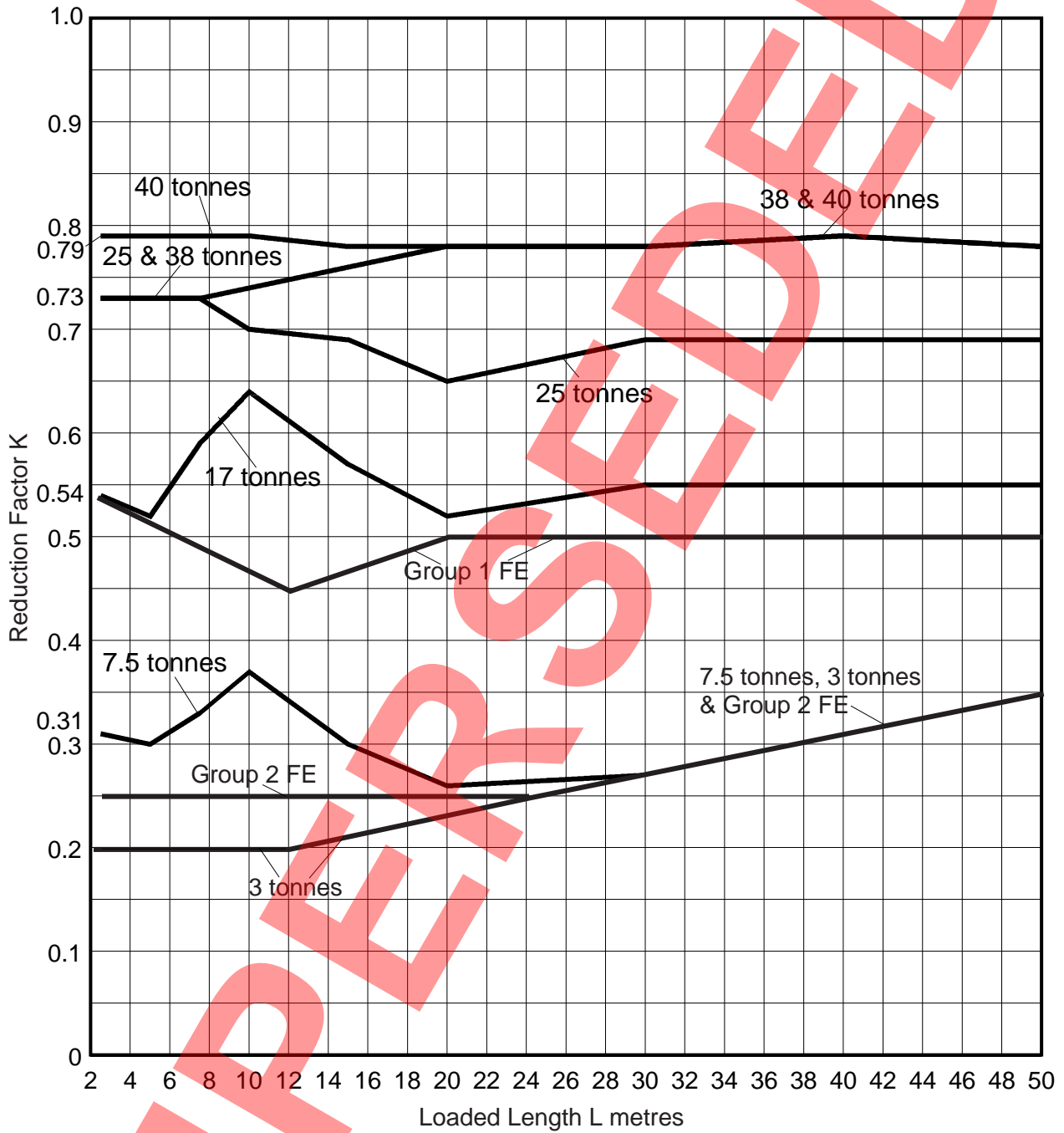

FIG 5/6. K Factors for Medium Traffic Good Surface (Mg)

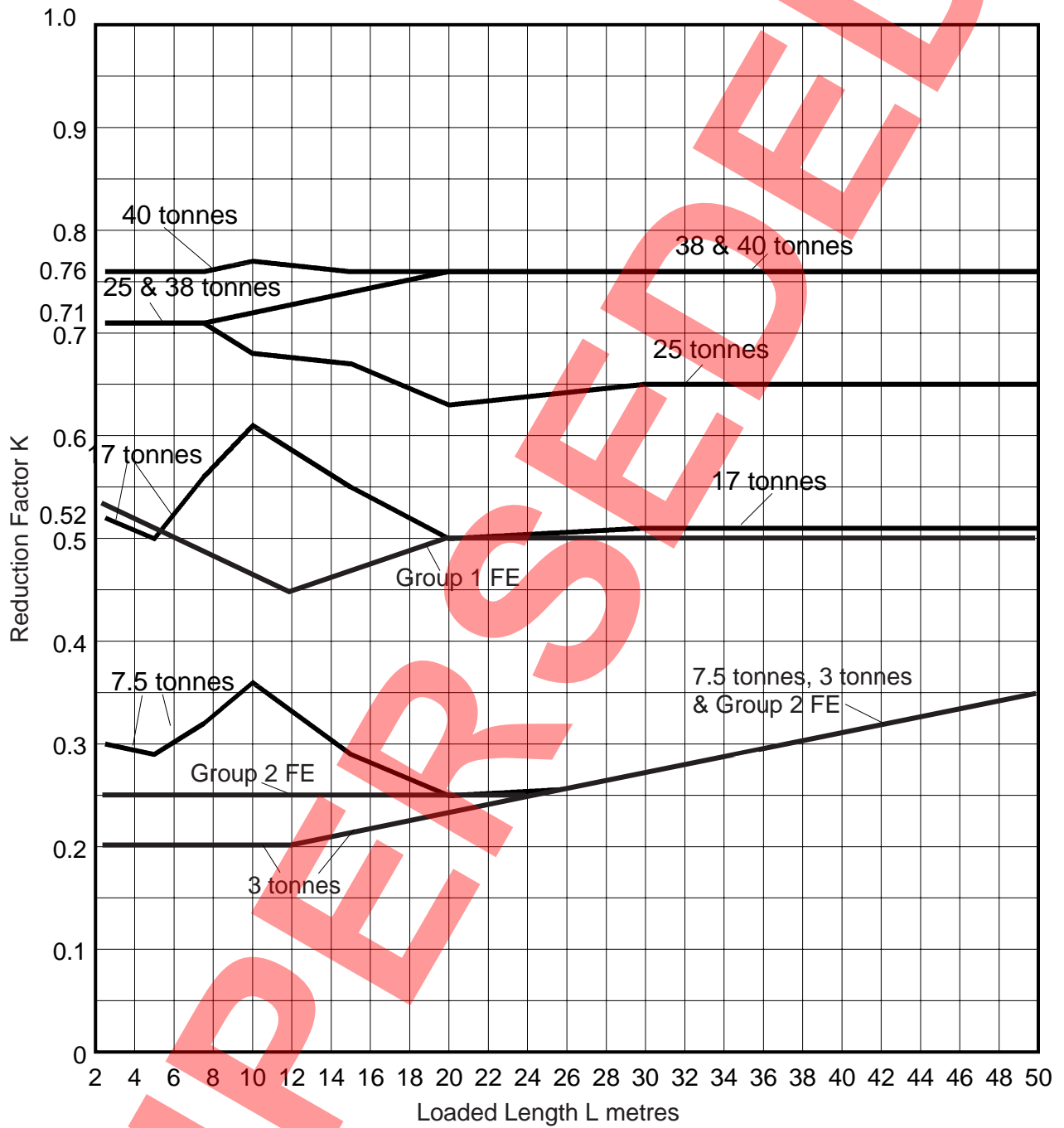

FIG 5/7. K Factors for Low Traffic Good Surface (Lg)

Table 5/3/1: Nominal Single Axle Loads (kN)

Assessment Live Loading	Road					
	Hp	Mp	Lp	Hg	Mg	Lg
40 tonnes	200	190	180	180	170	165
38 tonnes	180	176	170	165	160	150
25 tonnes	180	176	170	165	160	150
17 tonnes	180	176	170	165	160	150
7.5 tonnes	100	93	86	91	86	83
3 tonnes	50	47	43	47	43	40
FE Group 1	120	115	110	110	103	100
FE Group 2	60	57	55	55	51	50

Table 5/3/2: Nominal Single Wheels Loads (kN)

Assessment Live Loading	Road					
	Hp	Mp	Lp	Hg	Mg	Lg
40 tonnes	100	95	90	90	86	82
38 tonnes	100	95	90	90	86	82
25 tonnes	100	95	90	90	86	82
17 tonnes	100	95	90	90	86	82
7.5 tonnes	50	47	44	46	43	41
3 tonnes	25	22	21	22	21	19
FE Group 1	60	57	55	54	51	50
FE Group 2	30	29	27	27	26	25

Single Axle and Single Wheel Loads

General

5.31 Single axle and single wheel loads shall be applied separately as different load cases to the UDL and KEL or for application to loaded lengths of less than 2m. One axle load with 1.8m track positioned transversely or one wheel load shall be applied per lane. For the purposes of applying the axle load a 2.5m lane width shall be used for the disposition of the axles. A minimum transverse separation of 0.7m shall be taken between adjacent axles. The effects of full loading from axles in two adjacent lanes only shall be considered. For axles in other lanes factors as in 5.26 shall be applied to the loading effects. The disposition of the axle or wheel load is to be such as to cause the most severe effect on the structural element under consideration.

Nominal Single Axle Loads

5.32 The values of the single axle loads for the Assessment Live Loadings are given in Table 5.3.1. For FE loading, the values for the nominal single axle loads given in Table 5.4 are based on the maximum gross axle weights for the respective groups given in Appendix F. However, if the structure is to be assessed for a restricted range of vehicles within these groups, a lesser nominal axle value may be derived for these particular vehicles by multiplying their axle weights given in Appendix E by a conversion factor which shall be 1.2.

Nominal Single Wheel Loads

5.33 The values of nominal single wheel loads for the Assessment Live Loadings are given in Table 5.3.2.

Lesser nominal wheel loads may be determined, when applicable, for FE loading; these values shall be half the nominal FE axle loads determined in accordance with 5.32.

Wheel Contact Areas

5.34 The wheel loads for all loading levels shall be uniformly distributed over a circular or square contact area, assuming an effective pressure of 1.1 N/mm².

Accidental Wheel and Vehicle Loading

5.35 Members supporting central reserves, outer verges

and footways which are not protected from vehicular traffic by an effective barrier, shall be assessed for accidental wheel or vehicle loading.

For cantilevered members the appropriate accidental wheel loading arrangement for the level of Assessment Live Loading under consideration shall be selected from Table 5.4. For non-cantilevered members a single appropriate accidental vehicle shall be selected from and applied in accordance with Appendix D. No footway loading is required. The accidental wheel or vehicle loading shall be located in whatever lateral position which produces the most adverse effect on the element. Where the application of any wheel or wheels has a relieving effect, it or they shall be ignored. Wheel contact areas shall be as specified in 5.34. The methods of assessment of bridge deck cantilevers for accidental wheel loading given in Appendix J may be applied.

Footway Loading

5.36 Elements supporting footways shall be assessed for the worst effect of the loading given in 5.35, 5.37 or 5.38.

5.37 For elements supporting footways only, the pedestrian live load shall be taken as follows:

- (a) for loaded lengths of 36m and under, a uniformly distributed live load of 5.0 kN/m²;
- (b) for loaded lengths in excess of 36m, $k \times 5.0 \text{ kN/m}^2$ where k is the nominal HA UDL for appropriate loaded length (in kN/m) $\times 10$
 $L + 270$

Where L is the loaded length (in m).

Where the footway has a width exceeding 2m, these intensities may be reduced by 15% on the first metre in excess of 2m and by 30% on the second metre in excess of 2m. No further reduction for widths exceeding 4m shall be made. These intensities may be averaged and applied as a uniform intensity over the full width of the footway.

Special consideration shall be given to the intensity of the pedestrian live load to be adopted on loaded lengths in excess of 36m where exceptional crowds may be expected. Such loading shall be agreed with the appropriate authority.

5.38 For elements supporting footways and a carriageway, the pedestrian live load shall be taken as

Assessment Live Loading	W_1 (kN)	W_2 (kN)	a (m)
40 tonnes	100	60	1.5
38 tonnes	90	60	1.5
25 tonnes	90	40	1.5
17 tonnes	90	10	1.5
7.5 tonnes	50	10	1.5
3 tonnes	25	-	-
FE Group One	60	10	1.5
FE Group Two	30	20	1.5

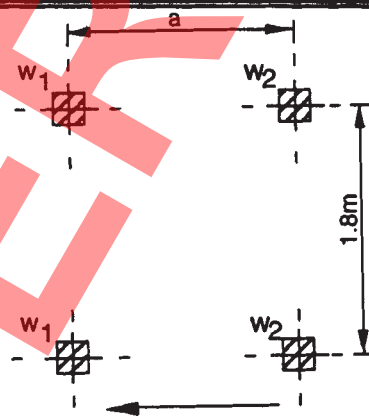

Table 5.4 Nominal Accidental Wheel Loads

0.8 of the value specified in 5.37 (a) or (b), as appropriate, except for loaded lengths in excess of 400m or where crowd loading is expected.

Where the footway has a width exceeding 2m, these intensities may be further reduced by 15% on the first metre in excess of 2m and by 30% on the second metre in excess of 2m. No further reduction for widths exceeding 4m shall be made. These intensities may be averaged and applied as a uniform intensity over the full width of footway.

Where a main structural member supports two or more notional traffic lanes, the footways loading to be carried by the main member may be reduced to the following:

On footways: 0.5 of the value given in 5.37 (a) and (b) as appropriate.

Where a highway bridge has two footways and a load combination is considered such that only one footway is loaded, the reductions in the intensity of footway loading specified in this clause shall not be applied.

Where crowd loading is expected or where loaded lengths are in excess of 400m, special consideration shall be given to the intensity of pedestrian live loading to be adopted. This shall be agreed with the appropriate authority.

Centrifugal Effects

General

5.39 The vertical effects arising from centrifugal forces on horizontally curved carriageways shall be determined by adjusting the static live load by application of the centrifugal effect factor* as given in 5.45. However, the application of an equivalent static live load for the purpose of determining centrifugal effects differs from the requirements of 5.6 and 5.12. There will hence be a need to also consider the live loading case ignoring centrifugal effects, in accordance with 5.6 and 5.12, to ensure that the most onerous live loading is applied for assessment purposes. Centrifugal effects may be ignored when any one of the following criteria applies:

- (i) the horizontal radius of curvature of the carriageway exceeds 600m;
- (ii) the span of the longitudinal element under consideration is greater than 15m;

- (iii) the bridge has a reinforced or prestressed concrete slab deck;
- (iv) for all internal longitudinal girders when the distance between centre lines of the outermost girders is less than 10m;
- (v) for longitudinal edge girders outside the carriageway, when the distance between the kerb line and the centre of the edge girder is greater than 0.5m.

For transverse members any enhancement of bending moments due to centrifugal action may be ignored. Enhancement of end shears may be ignored for spans greater than 6m.

* Note: A simplified method for considering centrifugal effects is given in BA 16 (DMRB 3.4.4) and may be applied for the assessment of bridge decks that comply.

5.40 Where the critical loading effect is due to a single axle, the loading specified in 5.31 to 5.34 for the Assessment Live Loading levels shall be considered as the equivalent static live load and shall be enhanced in accordance with the requirements of 5.45.

5.41 Where the critical loading effect is due to a single wheel, the loading specified in 5.31 to 5.34 shall be deemed to cover any increases in loading due to centrifugal effects.

Equivalent Static Live Load for UDL and KEL

5.42 The static live load shall be applied as two longitudinal line loads applied at 1.8m transverse spacing and two point loads applied at 1.8m transverse centres. One set of two longitudinal line loads and one set of two point loads shall be applied per lane width and shall be positioned to give the worst loading effect. The equivalent static load shall not be used for determining local effects in members.

5.43 The transverse positions of the line loads and point loads shall be coincident and the minimum transverse separation of adjacent sets shall be one metre.

5.44 The two longitudinal loads and two point loads shall be derived by dividing UDL and KEL values of assessment live loading by 2.

Centrifugal Effect Factor

5.45 The increased equivalent static live loads shall be determined by application of the centrifugal effect factor F_A , where:

$$F_A = 1 + \frac{0.20v^2}{r} \quad \text{but not greater than 2}$$

(derivation of expression for F_A is given in Appendix B)

v = speed of the vehicle* in m/s

r = radius of curvature of carriageway in metres.

Centrifugal effects need not be considered when F_A is less than 1.25.

* Note: The value to be taken for v shall correspond to the maximum speed at which heavier vehicles can travel along the curved carriageway on the bridge. Where the radius of curvature is the only determining influence on vehicle speed, v may be assumed as:

$$\left(\frac{1000r}{r + 150} \right)^{\frac{1}{2}}$$

Application of Centrifugal Effect Factor

5.46 The enhancement in live loading caused by centrifugal effects shall be determined by adjusting the equivalent static live load in accordance with Figure 5.8 and F_A as determined from 5.45.

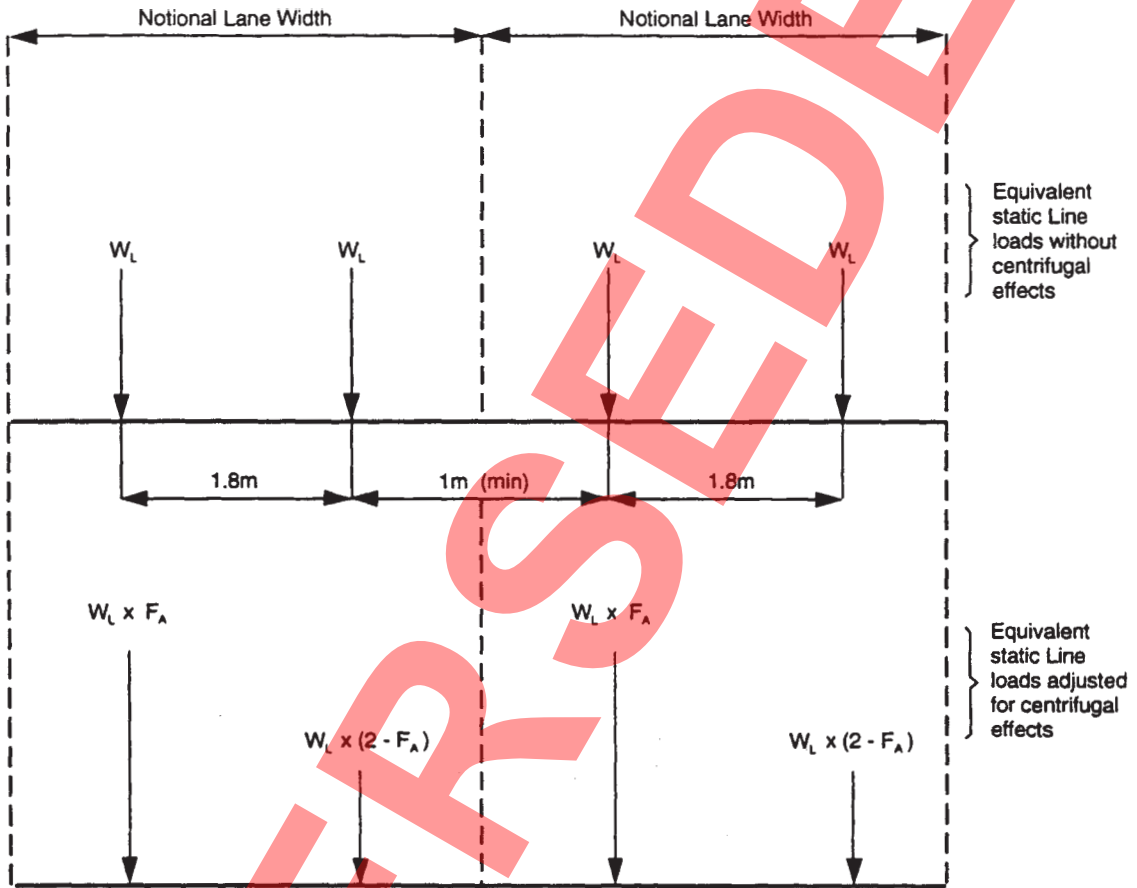

- Notes:
1. W_L is the longitudinal line load or point load derived in accordance with 5.44.
 2. Values of F_A shall be calculated from the formula given in 5.45.
 3. The static line loads shall be positioned within the notional lane widths to give the worst assessment loading effect.

Figure 5.8 Application of Centrifugal Effect Factor

6. ANALYSIS OF STRUCTURE

Distribution Methods

Global Analysis

6.1 In establishing the load capacity of a bridge, the effects of vehicle loading should be assessed by using some form of distribution analysis which will take advantage of the transverse distribution properties of the deck.

6.2 Some simple methods are given in BA 16 (DMRB 3.4.4), but the choice of the appropriate method will depend upon the structural form of the bridge and the required degree of accuracy. The simple methods, although conservative, are quick to use and should be tried initially where appropriate, before progressing to the more accurate but more complex computer methods.

Local Effects

6.3 Due allowance must be made for the local effects of wheel loads applied to particular elements of the bridge.

Assumptions

6.4 Methods of analysis should be in accordance with the principles set out in BS 5400: Part 1: 1988 as implemented by BD 15 (DMRB 1.3.2). Structures should be modelled as realistically as possible and whatever approach is adopted for representing member stiffnesses it should be used consistently throughout the structure. Elastic methods of analysis are acceptable as safe solutions for the ultimate limit state.

Effective Spans

6.5 The effective span shall be as specified in the appropriate parts of BS 5400 or the assessment versions. Where there are no bearing stiffeners and the beam rests directly on masonry, concrete or brick, the effective span should be taken as the distance between the centroids of the bearing pressure diagrams. In this case, the bearing pressure diagrams shall be determined by assuming that the reaction is distributed linearly from a maximum at the front edge of the support to zero at the back of the bearing area. The length of the bearing area shall not be taken as greater than the depth of the beam where the support is of soft brick, or one-quarter of the depth of the beam where the support is of hard material such as concrete or granite.

Section Properties

6.6 The section properties used for the calculation of member stiffnesses should be based on a realistic assessment of the state of the structure. Note should, therefore, be taken of corrosion, cracks, flaws and any other faults in either superstructure or substructure and due allowance made for the adverse effect in the assessment of member stiffnesses.

Dispersal of Loads for Decks Other Than Troughs

6.7 No allowance for the dispersal of the UDL and KEL shall be made. The dispersal of nominal wheel loads through surfacing and well compacted fill materials may be taken at a spread-to-depth ratio of 1 horizontally to 2 vertically from the edge of the wheel contact area. Dispersal through structural concrete slabs may be taken at spread-to-depth ratio of 1 horizontally to 1 vertically. Typical depths to which the dispersal may be taken are:

- (i) Hogging plates: the highest part of the plate;
- (ii) Jack arches: the level of the mid-depth of the arch ring at the crown;
- (iii) Reinforced concrete slabs: the level of the neutral axis.

6.8 Where the pressure diagrams from adjacent wheel loads overlap, the group of wheels may be treated as a whole and the load dispersed from the centres of the outside wheels of the group.

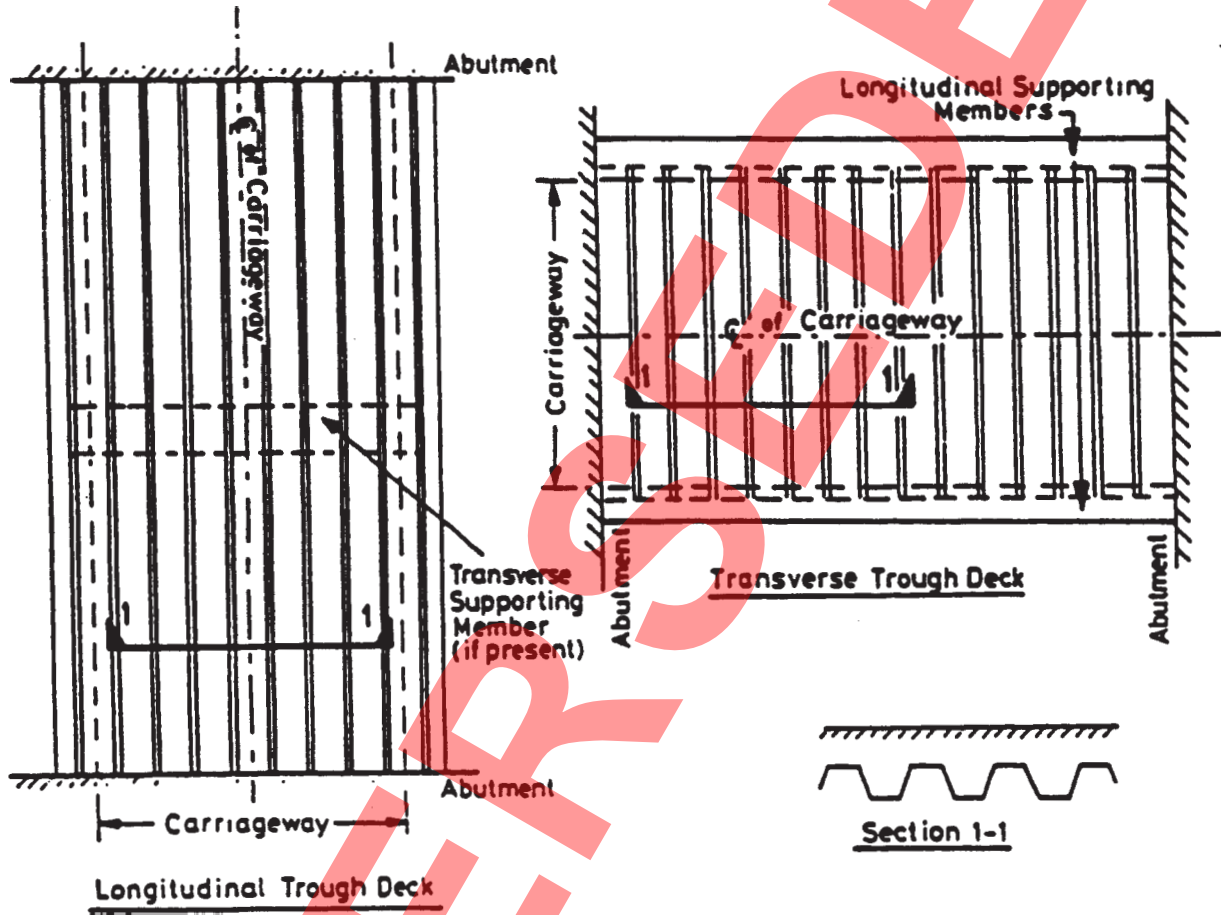

Figure 6.1 Longitudinal and Transverse Trough Decks

Dispersal and Distribution Through Trough Decks

General

6.9 The loading requirements for troughing are dependent upon the orientation of the troughs relative to the direction of the carriageway (see Figure 6.1) and differ from the requirements of 5.19 to 5.21. For longitudinal troughing, which runs parallel to the direction of the carriageway and spans between supporting transverse members or abutments, loading requirements are given in 6.10 to 6.12. For transverse troughing, which runs at a right angle to the direction of the carriageway and spans between supporting longitudinal members, loading requirements are given in 6.13. Requirements for the dispersal and distribution of loads for both longitudinal and transverse troughing are given in 6.14.

Loads for Longitudinal Trough Decks

6.10 The carriageway shall be divided into 2.5m notional lane widths. The Type HA live loading UDL shall be taken as two longitudinal strip loads and the KEL as two wheel loads applied in each notional lane. The value of each of the two longitudinal strip loads and two wheel loads shall be derived by dividing UDL and KEL values of assessment live loading values by 2.

6.11 Each longitudinal strip load shall be applied over a transverse width of 0.3m with a 1.8m transverse spacing between the centre lines of the two strips. The wheel loads shall be applied over a 0.3m x 0.3m square contact area with a 1.8m transverse spacing between their centres. One set of two longitudinal strip loads and one set of two wheel loads shall be applied per lane width and shall be positioned within the lane to give the worst loading effect. The transverse positions of the strip loads and wheel loads shall be coincident and the minimum transverse separation of adjacent sets, measured between the centre lines of the longitudinal strip loads or centres of the wheel loads, shall be 0.7m. Assessment Live Loading values shall be determined by the application of Reduction Factors in accordance with 5.22.

6.12 The longitudinal troughing shall also be separately assessed for the single axle and single wheel loads given in 5.31 to 5.34.

Loads for Transverse Trough Decks

6.13 Transverse troughs shall be assessed for the effects of Assessment Live Loadings on the basis of a single axle and/or a single wheel load in accordance with 5.31 to 5.34. The values of the single axle loads given in Table 5.3.1 shall be multiplied by the appropriate enhancement factors given in Table 6.1, depending on the depth from the road surface to the top of the troughing. These enhancement factors allow for the presence of other axles on the vehicles including bogies. The values of the single wheel load given in Table 5.3.2 do not require any enhancement.

Dispersal and Distribution of Loads

6.14 For longitudinal and transverse troughs the load shall be dispersed as shown in Figure 6.2. Provided the troughs are adequately connected, the load may be assumed to be carried by a width of troughing extending equally on either side from a vertical line through the centre of the load for a distance equal to twice the width of the dispersion area. The distribution of load between these troughs shall be taken as linear, being zero at the outer trough and a maximum at the trough under the load (see Case A in Figure 6.2). The proportion of the load taken by individual troughs is given by the ratio obtained by dividing the area of the portion of the distribution diagram that corresponds to the trough width by the total area of the diagram. The distribution diagram for adjacent strip and/or wheel loads may overlap (see Case A in Figure 6.2), and when this occurs the amount of load taken by a trough located within the overlap area shall be obtained by adding the individual loads determined from the respective distribution diagrams. Where the actual troughing does not extend for the distance assumed or where there is a joint of inadequate strength, the amount of load carried by each trough shall be assessed from the ordinates of a distribution diagram as shown in Case B, Figure 6.2. If the edge of the outside trough is stiffened or otherwise supported due consideration may be given to this.

Assessment Live Loading	Depth from road surface level to top of troughing (m)									
	0.2	0.3	0.4	0.5	0.6	0.7	0.8	0.9	1.0	1.5
40 tonnes	1.00	1.04	1.08	1.13	1.17	1.21	1.25	1.30	1.34	1.55
38 tonnes	1.00	1.04	1.08	1.12	1.16	1.19	1.23	1.27	1.31	1.50
25 tonnes	1.00	1.00	1.04	1.08	1.13	1.15	1.18	1.20	1.23	1.35
17 tonnes	1.00	1.00	1.00	1.00	1.03	1.05	1.08	1.10	1.11	1.15
7.5 tonnes	1.00	1.00	1.02	1.03	1.05	1.06	1.07	1.08	1.09	1.10
3 tonnes	1.00	1.00	1.00	1.00	1.00	1.00	1.00	1.00	1.00	1.00
FE Groups One & Two	1.00	1.00	1.00	1.00	1.00	1.00	1.03	1.06	1.09	1.16

Note: Linear interpolation may be used for intermediate values

Table 6.1 Transverse Troughing Enhancement Factors

Figure 6.2 Dispersal and Distribution of Load Through Troughing

Case A

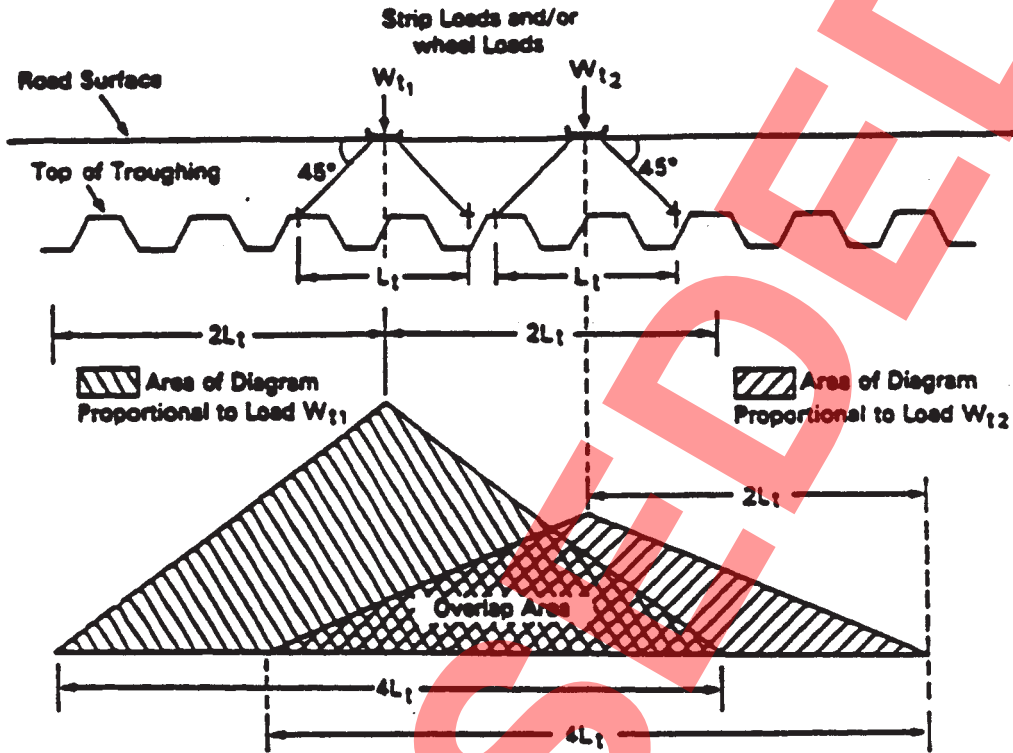

Note: $4L_t$ = Width of Troughing Supporting the Dispersed Loads.

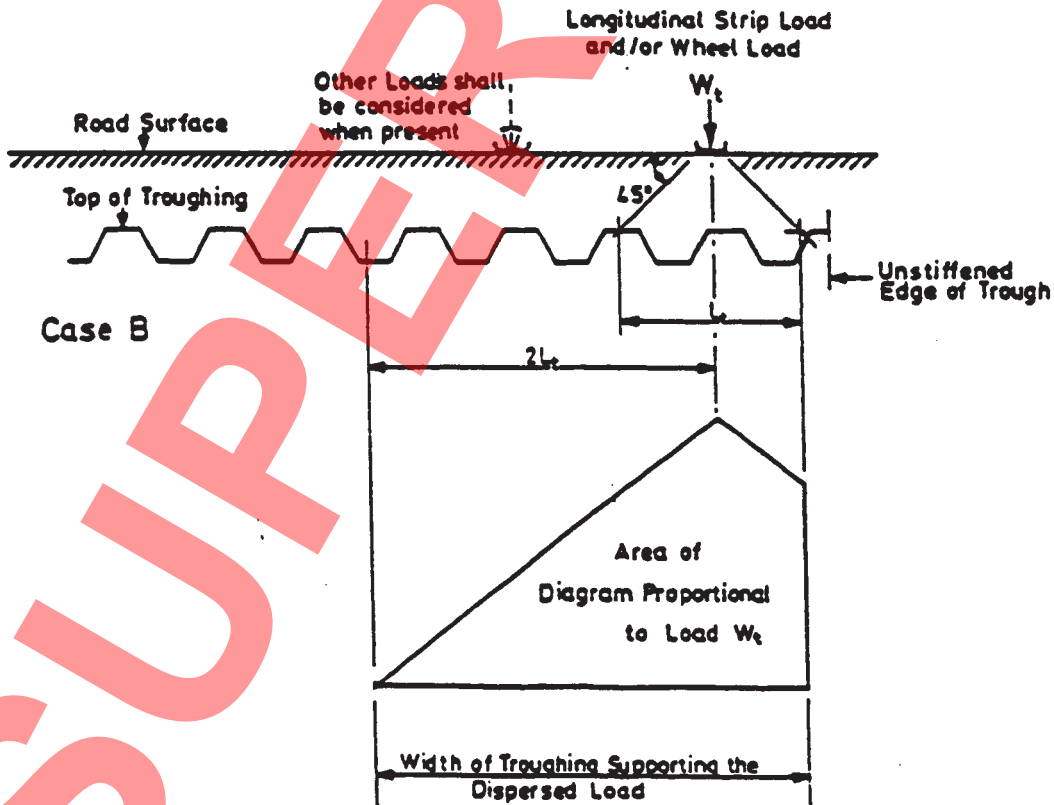

Case B

Modified MEXE Method

6.15 The Military Engineering Experimental Establishment (MEXE) developed a simple empirical method for assessing the capacity of masonry arches for carrying military traffic. It is based on theoretical studies carried out by Pippard (1) supported by observations of the behaviour of arches under actual live loads. The method, which takes account of the condition of the arch barrel and its geometric properties, has been further modified to suit normal civilian highway traffic.

6.16 The method uses a nomogram, or, alternatively an equation, to obtain a permissible provisional permissible axle loading (PAL), depending on the span, ring thickness and depth of fill. This value is then modified by factors which allow for the influence of other important parameters. The method is limited to arches with a maximum span of 18m. Details of the method are given in BA 16 (DMRB 3.4.4) and it shall be used wherever possible before any of the more complex methods described in 6.17 to 6.25 are tried.

Alternative Methods

6.17 The modified MEXE method is generally considered to be an approximate method suitable for preliminary assessment. However, if such an assessment indicates that the bridge is inadequate, the result must be confirmed by a more rigorous assessment. Furthermore, when the depth of fill at the crown is greater than the thickness of the arch barrel, the results shall again be confirmed using an alternative method. There is a possibility that for such cases the MEXE method may be unconservative.

6.18 A number of computer programs have recently been developed specifically for assessing the capacity of masonry arch bridges. Before using such a program, the assessing engineer should satisfy himself that the basic analysis is sufficiently accurate and also that the program gives consistent results for the types of bridges it covers. One method for ensuring this would be to validate the program against available full scale test results, such as those from the 10 tests organised by TRL (Ref 11).

6.19 A comparison of three different methods of assessment is described in BA 16 (DMRB 3.4.4). In using any method other than the modified MEXE method the following rules shall be complied with:

- (i) When a bridge is found to have a lower capacity than that given by the modified MEXE method, the MEXE assessment shall stand unless there is good reason to believe that it is unconservative for the case in question, for example when the fill depth is greater than the arch thickness;
- (ii) The alternative method shall be used in accordance with 6.20 to 6.25 to determine the collapse load for the bridge, from which the assessed capacity shall be obtained.

Factors of Safety

6.20 Structural adequacy shall be checked using Equation 2a in 3.20 with the following factors of safety:

$\gamma_{fL} = 3.4$ for one of the axles and 1.9 for the others. For bogies, γ_{fL} of 3.4 should be applied to the critical axle, see Table 6.2. (See Appendix H for basis.)

Where a check for Type HB loading is carried out then $\gamma_{fL} = 2.0$.

$\gamma_{f3} = 1.0$, if the method has been validated against test results, otherwise 1.1. If a method is found to give consistently higher or lower results than a statistically significant number of test results, a different value of γ_{f3} may be adopted for the method.

$\gamma_m = 1.0$, if F_c takes into account material deterioration.

6.21 The overall condition factor F_c will depend upon the method and is intended to cover deterioration in material properties as well as defects in the structure such as those covered by the condition factor F_{cm} (see 3.18 and 3.19) and the joint factor F_j of the modified MEXE method. In the computer-based Pippard-MEXE method described in BA 16 (DMRB 3.4.4), this overall condition factor is to be taken as the product of F_{cm} and F_j calculated for a modified MEXE assessment. If any aspect of material deterioration or any structural defect can be and is taken account of directly in a particular method, F_c should be modified accordingly. It is imperative that double counting in this respect is avoided.

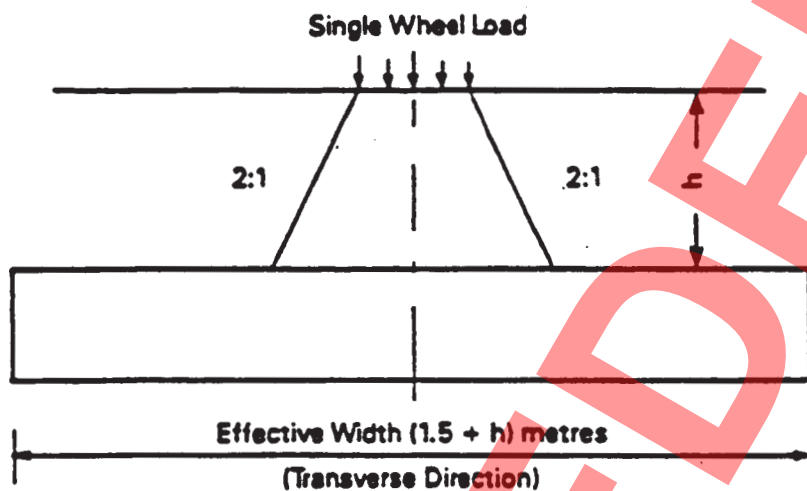

Figure 6.3 Effective Width Under a Wheel Load

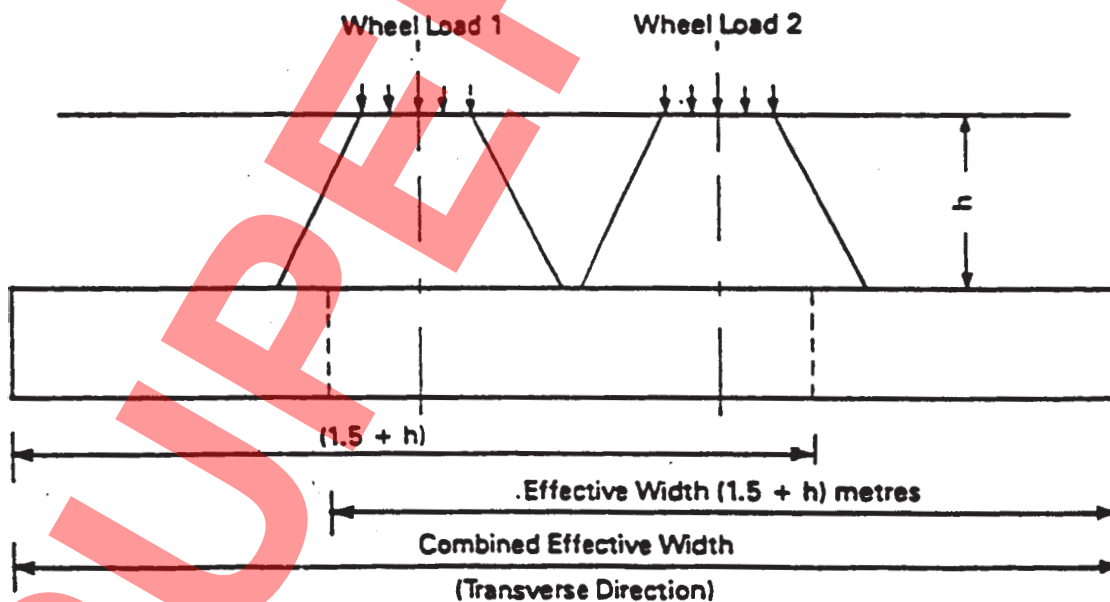

Figure 6.4 Combined Effective Width

Wheel Load Dispersal

6.22 In the longitudinal direction, any applied wheel load shall be deemed to have a dispersal of 2 vertical to 1 horizontal through the fill material. Transversely, the effective width of the arch barrel carrying a wheel load applied at any position along the span can be derived as shown in Figure 6.3 from the following formula:

$$w = h + 1.5 \text{ (See Appendix H for basis)}$$

where h is the fill depth at the point under consideration and both w and h are in metres. The effective width for a number of wheel loads located transversely on the carriageway is the combined effective width as shown in Figure 6.4, the overall width of the barrel or the width of the part of the barrel between two longitudinal cracks, whichever is the least. When the third option is used, any longitudinal cracks should be ignored when determining F_{cm} .

6.23 The live loading to be applied to arches shall be the single, double and triple axles given in Appendix A for current C&U vehicles and EC vehicles up to 40/44 tonnes gross vehicle weight. The nominal values of the axle weights shall be determined by multiplying the gross axle weights obtained from Appendix A by the appropriate conversion factors given in Table 6.2. The possibility of lift-off in a double or triple axle bogie shall be considered if the conditions on the arch are likely to cause this effect (see BA 16 (DMRB 3.4)). The axles shall be assumed to have a 1.8m track and shall be located within 2.5m transverse lane widths, with a 0.7m minimum spacing between the track width of adjacent vehicles.

6.24 For arch spans greater than 20m, the capacity shall also be checked for 40 tonnes or 38 tonnes Assessment Live Loading by application of the Type HA UDL and KEL, as given in 5.19 to 5.21, appropriate to a loaded length equal to half the arch span and positioned to produce the most onerous effect, multiplied by the respective reduction factors given in 5.22.

6.25 Live loads must be factored for the ultimate limit state. Two analyses should be made - one with unfactored dead load, to represent an estimate of the least permanent load present when live load is applied, and one with all dead loads factored for the ultimate limit state, to represent the greatest total load which may be present on the structure.

Bogie Combination and/or Axle		Conversion Factors		
		No Axle lift-off	With axle lift-off	
Single Axle		1.0	-	
Double Axle Bogie	Critical Axle	1.0*	1.28*	
	Other Axle	1.0	0.50	
Triple Axle Bogie	An Outer + Middle Axle	1.0	1.50	1.28*
	Middle Axle	1.0*	1.0*	1.0
	Other Outer + Axle	1.0	0.50	0.50

* Critical axle of bogie to be located at a position to cause the most adverse loading effect.

+ Conversion factor values for outer axles are interchangeable to determine the most adverse loading effect.

Note: Where an assessment is being carried out for bogies with air or fluid suspension, the conversion factors for the no axle lift-off case shall apply irrespective of the conditions on the arch.

Table 6.2 Nominal Axle Weight Conversion Factors

Multispan Masonry Arch Bridges

6.26 Multispan masonry arch bridges shall be assessed using the following principles:

- (i) Any individual span of the bridge may be assessed as a single span arch provided the adjacent intermediate supports and spans are structurally adequate;
- (ii) The intermediate supports and the adjacent spans are to be considered adequate if, at the ultimate limit state (ULS), when the live loading is placed only on the span under question (in order to produce the worst horizontal thrusts on the adjacent parts of the structure), no tension occurs

in any cross-section of the supports or the adjacent spans. The critical sections are the top and the base of a support and the near mid-span and the springings of the adjacent spans;

- (iii) Any individual span may be assessed as a single span arch, even if tension develops in the adjacent supports and the springings of the adjacent spans under the conditions described in (ii) above, provided there is no tension anywhere else in these elements when the sections with tension are represented as hinges.

6.27 The ultimate limit state (ULS) checks described in the previous clause may be carried out using elastic finite element or frame analysis. In order to produce upper bound horizontal thrusts in the span loaded with live load, the section underneath the critical axle load should be represented as a hinge. Any other suitable analysis method may also be used to carry out the checks, provided the principles given in 6.26 are adhered to.

6.28 In idealising the structure for the above checks, full advantage shall be taken of any concrete or other strong infill between the arches or any haunching at the junctions. Such constructional details have the effect of raising the line of the horizontal thrust onto the adjacent arch thereby reducing the likelihood of any tension occurring at the top of the adjacent arch.

6.29 The assessing engineer, from experience, may decide the above checks to be unnecessary for bridges with short and stocky intermediate piers and simply assess each span as an individual single span arch.

7. STRENGTHS OF MEMBERS

General

7.1 The strengths of members shall be assessed in accordance with the relevant requirements given in this chapter. Several modes of failure may need to be considered.

7.2 Dimensions of members may be obtained from records but should be checked on site, due allowance being made for corrosion, spalling and other defects.

Steel

7.3 The strength of steel members shall be assessed in accordance with BD 56 (DMRB 3.4). The rules for webs in BD 56 (DMRB 3.4) can be applied to riveted construction by means of the following conversion.

7.4 In the expression for m_{fw} in 9.9.2.2 of BD 56 (DMRB 3.4), replace $b_{fe} t_f^2$ by $2z_p$ where z_p is the plastic modulus of the flange section consisting of the flange plate or plates and the flange angles.

7.5 It is essential to inspect the structure carefully and to take measurements of thicknesses, especially where there is evidence of corrosion or reason to suspect it, eg at the base of a web plate. It may be necessary to remove some concrete or road materials. The actual minimum section should be used in the calculations.

7.6 Members should be checked for laminations, defect and cracks.

7.7 Splices on flanges and webs may govern the strength, especially in old bridges.

7.8 Rivets should be examined for corrosion, especially on the underside of decks or in places where access for maintenance is difficult. The effects on rivets of alternating loads (stress reversal) should be allowed for.

Concrete

7.9 The strength of concrete members shall be assessed in accordance with BD 44 (DMRB 3.4).

Note: The requirements of BD 56 (DMRB 3.4) are applicable to steelwork which has been fabricated and erected in accordance with the requirements of

BS 5400 : Part 6. If it is considered that steel members were fabricated and erected to Standards that differ from BS 5400 : Part 6 requirements, and that these differences are likely to adversely influence the strength of members, an appropriate value for the condition factor, F_{cm} , shall be taken into account for these variations (see 3.18 and 3.19).

7.10 If there is evidence of corrosion or damage in reinforcement, the cross-sectional areas of the corroded bars shall be assessed for inclusion in strength calculations. In cases where severe loss of cross section has occurred, consideration shall be given to the possible reduction in strength and ductility of the bars in accordance with 4.3 to 4.6.

The assumed reduced size shall be recorded in the Structure File so that adjustments can be made in any subsequent assessment, in accordance with the documents contained in Volume 3, Section 1 of the Design Manual for Roads and Bridges (DMRB 3.1).

Wrought Iron

7.11 Wrought iron is a material similar to steel and members should be assessed in accordance with 7.3 to 7.8.

Cast Iron

7.12 Cast iron members are to be assessed on a permissible stress basis only, in accordance with 3.6 and using the permissible stresses in 4.10 and 4.11.

7.13 The section modulus of cast iron girders may be increased for live loading by the factor D/d (see paper by C S Chettoe, N Davey and G R Mitchell (Ref 6)) where D is the overall depth of the deck less 75mm for surfacing material and d is the depth of the bare girder at midspan provided the following conditions are present:

- (i) The girders are known to be firmly embedded in well consolidated filling material, other than pure sand or pure clay;
- (ii) There are no services in the carriageway which would decrease the support rendered by the fill, eg stoneware pipes or large diameter water or gas mains.

7.14 The factor D/d shall not be applied to longitudinal girders consisting of cast iron troughs. The maximum value for D/d which may be applied to the section modulus of cast iron sections for live load, shall not exceed 2.0. Should openings be made in the carriageway after an assessment which used the D/d factor, the opening must be back filled with concrete, or the assessment reconsidered.

7.15 Cast iron struts that are adequately braced should be assessed by the Gordon-Rankine equation as follows:

$$P = (2 \times 10^{-4}) \times (f_c \cdot A) / \left(1 + \frac{F \cdot a \cdot L_s^2}{K_r^2} \right)$$

- where P = safe load (kN)
- f_c = compressive yield stress
= 555 N/mm²
- A = cross-section area (mm²)
- L_s = length (mm)
- K_r = least radius of gyration (mm)
- F = end fixity factor given in Table 7.1
- a = material factor, $\frac{1}{1600}$

Masonry

7.16 The strength of masonry members shall, in general, be assessed in accordance with 4.12 and BS 5628, except that in the case of arch barrels the empirical modified MEXE method of assessment (see 6.15 and 6.16) should be used at least as a first approximation.

Composite

7.17 The strength of composite members shall be assessed in accordance with BD 61 (DMRB 3.4).

End Condition	<i>F</i>
Both ends pin jointed	1
One end fixed, one end pin jointed	0.5
Both ends rigidly fixed	0.25
One end fixed, one end entirely free	4

Table 7.1 Values of End Fixity Factor (*F*)

8. SUB-STRUCTURES, FOUNDATIONS AND WALLS

General

8.1 This chapter deals with the assessment of the sub-structures and foundations for all types of bridges, retaining walls, dry-stone walls and spandrel walls to arch bridges. It should be noted that in most cases these structures are not amenable to assessment by calculation and must be assessed qualitatively by considering the condition of the structure and the significance of any defects. Advice on the assessment of these structures is given in BA 16 (DMRB 3.4.4) and BA 55 (DMRB 3.4.9). The requirements for the inspection of these structures are given in Chapter 2 of this Standard, with particular emphasis being placed on the various defects which should be identified.

Sub-structures, Foundations and Retaining Walls

8.2 The assessment of sub-structures, foundations and retaining walls should be based upon the results of their detailed inspection. Advice on the interpretation of these observations is given in BA 16 (DMRB 3.4.4).

8.3 However, in certain circumstances an analytical assessment approach shall be adopted (see 2.1 to 2.13, Chapter 3 and BA 55 (DMRB 3.4.9)).

8.4 If for any reason the dead load applied to the sub-structure, foundations or retaining walls is to be increased, the form and extent of the foundations must be determined and the adequacy of the subsoil to carry the additional loads proved using conventional ground investigation techniques.

8.5 If a foundation, retaining wall or a substructure shows no signs of distress, if there is no evidence of scour either externally or internally, and if no significant increases in load are envisaged, then the foundation, retaining wall or sub-structure may be assumed to be adequate and no further assessment is necessary.

Dry-stone Walls

8.6 The assessment of dry-stone walls should be based upon the results of visual surveys of the structures. Advice on the interpretation of these observations and their application to the assessment of dry-stone walls is given in BA 16 (DMRB 3.4.4).

Spandrel Walls

8.7 Spandrel walls affect the carrying capacity of arch bridges and should be assessed separately from the arch barrel. They should not be assumed to provide support or strength to arch barrels. The assessment of spandrel walls should be based upon the results of visual surveys. Advice on the interpretation of these observations and their application to the assessment of spandrel walls is given in BA 16 (DMRB 3.4.4).

9. ASSESSMENT FOR RESTRICTED TRAFFIC

General

9.1 Structures which cannot sustain the 40 tonnes Assessment Live Loading, and which are not scheduled for immediate replacement or strengthening, shall be reassessed to ascertain their capacity to carry the 38 tonnes Assessment Live Loading. If they are still found to be inadequate they shall be reassessed in accordance with 9.2 to 9.4 for the levels of restricted Assessment Live Loading as described in 9.5 to 9.9. In some cases it may be possible to carry a higher level of Assessment Live Loading by imposing lane restriction as described in 9.10 to 9.13. Where a structure cannot sustain the 17 tonnes or 7.5 tonnes Assessment Live Loading, it may be necessary to check which types of Fire Engines (FE) can be carried in accordance with 9.5 to 9.9. A structure which cannot carry the 7.5 tonnes Assessment Live Loading may be assessed for 3 tonne Assessment Live Loading (Car loading), if it is considered desirable to keep the bridge open under this level of loading. When the structure cannot sustain any of the loadings described in this Standard, it should be considered for immediate closure. The relationship between assessment and weight restrictions is considered in 9.14 to 9.20.

Method of Reassessment for Restricted Loadings

Superstructures (Except Masonry Arch Bridges)

9.2 The reassessment should be carried out for the appropriate level of Assessment Live Loading as described in 9.5 to 9.9. Requirements for determining Assessment Live Loading effects are given in 5.8 to 5.34. These live loading effects shall be added to the other assessment load effects in accordance with 3.7 to 3.10.

Masonry Arch Bridges

9.3 The maximum axle loads that correspond to the Assessment Live Loadings given in 9.5 to 9.9 are listed in Appendix F. The modified MEXE method for the assessment of these structures determines the value of the allowable axle or bogie loading directly.

Sub-structures and Foundations

9.4 Generally the requirements of Chapter 9 are not applicable to the assessment of sub-structures and

foundations. Their assessment is primarily based on the qualitative judgement of information obtained during inspection, in accordance with the requirements of Chapter 8. However, if inspection reveals signs of distress in the sub-structures and/or foundations, consideration should be given to whether reducing the live loading would alleviate the distress. If this is felt to be the case, it would be appropriate to supplement the requirements of Chapter 8 with the imposition of weight restrictions corresponding to a level of Assessment loading in accordance with 9.14 to 9.19.

Reduced Vehicular Loadings

9.5 The main levels of restricted Assessment Live Loading which may be used for reassessment are described in 5.8 to 5.34 and are as follows:

- (i) 25 tonnes Assessment Live Loading;
- (ii) 17 tonnes Assessment Live Loading;
- (iii) 7.5 tonnes Assessment Live Loading.

9.6 These loadings shall be used to assess the appropriate gross vehicle weight that the structure is capable of carrying.

9.7 For masonry arches the additional Assessment Live Loading levels of 33 tonnes, 13 tonnes and 10 tonnes given in Appendix F should also be considered.

9.8 In addition the FE loadings, which are also described in 5.8 to 5.34, may be used to check which groups of these vehicles may still be permitted to use a structure when the structure cannot carry the 17 tonnes Assessment Live Loading. A structure may be capable of carrying an FE of greater gross weight than that permitted under the corresponding main level of Assessment Live Loading, because the construction of FEs is such that their axle configuration and weight distribution impose a lesser loading on the structure than the most critical C&U vehicles. Additionally, the structure may be marginally stronger than the minimum required to carry the restricted Assessment Live Loading.

9.9 In appropriate circumstances and as an alternative to complete closure, the 3 tonnes Assessment Live Loading may be used for the assessment of structures that are not capable of

sustaining the 7.5 tonnes Assessment Live Loading.

Loading With Lane Restrictions

General

9.10 In some cases it may be feasible to sustain the 40 tonnes, 38 tonnes or a specified level of restricted Assessment Live Loading by the imposition of lane restrictions which reduce either the number and/or the width of lanes available for traffic. When determining the feasibility of adopting lane restrictions, consideration shall be given to the effect on traffic flow. Lane restrictions, particularly restrictions requiring one-way operation, may impose severe delays.

Assessment Method

9.11 The reduced carriageway width shall be divided into notional lanes in accordance with 5.6. The Type HA loading is applied to these notional lanes taking into account the reductions given in 5.25 and 5.26. It should be noted that additional analysis will be required as it is not possible to derive the loading effects for the restricted lanes directly from the Type HA loading effects derived for unrestricted lanes. Appropriate Reduction Factors from 5.8 to 5.34 shall be applied to the Type HA loading effects to determine the level of Assessment Live Loading which can be carried by the restricted lanes.

9.12 In the assessment, care must be taken to ensure that the disposition of the restricted lanes does not impose an unduly adverse distribution of loading on particular parts of the structure.

Application

9.13 Lane restrictions shall be applied by physically constraining the carriageway width available to vehicles by use of obstructions such as kerbs, raised paving, barriers, etc. The additional superimposed dead loads from such obstructions shall be considered in the assessment. The use of markings on the existing road surface to delineate the carriageway width is not a reliable method for applying the restriction in dense traffic conditions.

Weight Restrictions

General

9.14 All structures, assessed by the use of this

Standard, shall, where required, be restricted in terms of gross vehicle weight. A structure which can sustain the 40 tonnes or 38 tonnes Assessment Live Loading will not require to be weight restricted. If it cannot carry these loads, the structure should be reassessed for one of the other Assessment Live Loading levels, ie 25 tonnes Assessment Live Loading (9.15), 17 tonnes Assessment Live Loading (9.16) or 7.5 tonnes Assessment Live Loading (9.17). Structures which cannot carry 7.5 tonnes Assessment Live Loading may, in appropriate circumstances, be assessed for the 3 tonnes Assessment Live Loading (9.18). A group or groups of FEs may be excluded from the gross vehicle weight restrictions provided that the structure has been shown to be capable of sustaining the loading for the appropriate group or groups of FEs (9.19).

9.15 25 tonnes Assessment Live Loading. When a structure can sustain the 25 tonnes Assessment Live Loading but not the 38 tonnes Assessment Live Loading, the weight restriction shall be 25 tonnes gross vehicle weight (gvw).

9.16 17 tonnes Assessment Live Loading. When a structure can sustain the 17 tonnes Assessment Live Loading but not the 25 tonnes Assessment Live Loading, the weight restriction shall be 17 tonnes gross vehicle weight (gvw).

9.17 7.5 tonnes Assessment Live Loading. When a structure can sustain the 7.5 tonnes Assessment Live Loading but not the 17 tonnes Assessment Live Loading, the weight restriction shall be 7.5 tonnes gross vehicle weight (gvw).

9.18 3 tonnes Assessment Live Loading. When a structure can sustain the 3 tonnes Assessment Live Loading but not the 7.5 tonnes Assessment Live Loading, the weight restriction shall be 3 tonnes gross vehicle weight (gvw).

9.19 FE loading. The group(s) of FE that may be excluded from the vehicle restriction order for structure, that can only sustain 7.5 tonnes Assessment Live Loading or 3 tonnes Assessment Live Loading, shall be determined by reference to Appendix E.

Weight Restrictions for Masonry Arch Bridges

9.20 When the capacity of the arch is assessed in terms of allowable axle and bogie loads, the appropriate level of weight restriction shall be determined from Appendix F. This lists the required axle load capacities

in terms of gross vehicle weights for all the levels of loading described in 9.5 to 9.9 together with additional levels at 33, 13 and 10 tonnes respectively.

Restriction Signs

9.21 The Traffic Signs Regulations and General Directions 1994 has been issued, and the weight restriction signs changed. In Northern Ireland The Traffic Signs Regulations (Northern Ireland) 1979 apply.

SUPERSEDED

10. REFERENCES

The following documents are referred to in the text of the Standard:

1. Pippard A.J.S - 'The Approximate Estimation of Safe Loads on Masonry Bridges' - Civil Engineer in War, I.C.E. 1948.
2. Heyman J. - 'The Estimation of the Strength of Masonry Arches' - ICE Proceedings Part 2, December 1980 pp 921-937.
3. Heyman J. - 'The Masonry Arch' - Ellis Horwood, 1982.
4. Pippard A.J.S. and Baker J.F. - 'The Analysis of Engineering Structures' - Edward Arnold, 1968.
5. Morice P.B., and Little G. - 'The Analysis of Right Bridge Decks Subjected to Abnormal Loading' - Cement and Concrete Association, London, 1956 pp 43.
6. C.S. Chettoe, N.Davey and G.R.Mitchell - 'The Strength of Cast Iron Bridges' - Journal of the Institution of Civil Engineers No 8 October 1944.
7. 'Traffic Signs Manual' 1982 - HMSO.
8. M.A. Crisfield and A.J. Packham - 'A mechanism program for computing the strength of masonry arch bridges 2' - TRRL Research Report 124, 1987.
9. 'First Report on Prestressed Concrete' - Institution of Structural Engineers, 1951.
10. Hendry A - 'Masonry Properties for Assessing Arch Bridges' - TRRL Contractor Report No. 244, TRRL, Crowthorne, 1991.
11. Page J. - 'Assessment of Masonry Arch Bridges' - Proceedings of the Institution of Highways and Transportation National Workshop, Leamington Spa, March 1990.
12. Davy N. - 'Tests on Road Bridges' - National Building Studies Research Paper No. 16, HMSO, 1953.
13. Chettoe CS and Henderson W - 'Masonry Arch Bridges. A Study' - Proc Inst. Civ Engrs, London, 1957.
14. The following is a list of British Standards to which reference is made in this Standard:
BS 15 : 1948 : Mild Steel for General Structural Purposes
BS 427 : Methods of Vickers Hardness Test
BS 648 : 1964 : Schedule of Weights of Building Materials
BS 968 : 1962 : High Yield Stress (Welding Quality) Structural Steel
BS 2762 : 1956 : Notch Ductile Steel for General Structural Purposes
BS 2846 : Part 3 : 1975 Determination of Statistical Tolerance Interval
BS 4360 : 1986 : Weldable Structural Steels
BS 5268 : Code of Practice for the Structural Use of Timber
BS 5400 : Steel, Concrete and Composite Bridges
Part 3 : 1982 : Code of Practice for Design of Steel Bridges, including Amendment No. 1
Part 6 : 1980 : Specification for Materials and Workmanship, Steel
Section 9.1 : 1983 : Code of Practice for Design of Bridge Bearings
Section 9.2 : 1983 : Specification for Materials, Manufacture and Installation of Bridge Bearings
Part 10 : 1980 : Code of Practice for Fatigue
BS 5628 : Code of Practice for the Structural Use of Masonry
Part 1 : 1978 : Unreinforced Masonry
BS 6089 : 1981 : Guide to Assessment of Concrete Strength in Existing Structures

15. The following is a list of documents in the Design Manual for Roads and Bridges to which reference is made in this Standard:

Volume 1 Section 3 General Design

BD 9/81 Implementation of BS 5400 : Part 10 : 1980

BD 15/92 General Principles for the Design and Construction of Bridges: Use of BS 5400 : Part 1 : 1988

BD 37/88 Loads for Highway Bridges

Volume 2 Section 2 Special Structures

BD 31 Buried Concrete Box Type Structures

SB 3 Rigid Buried Concrete Structures *[for use in Scotland only]*

Volume 3 Section 3 Repair

BA 35 The Investigation and Repair of Concrete Highway Structures

Volume 3 Section 4 Assessment

BD 34 Technical Requirements for the Assessment and Strengthening Programme for Highway Structures - Stage 1 - Older Short Span Bridges and Retaining Structures

BD 44 The Assessment of Concrete Highway Bridges and Structures

BD 46 Technical Requirements for the Assessment and Strengthening Programme for Highway Structures - Stage 2 - Modern Short Span Bridges

BD 50 Technical Requirements for the Assessment and Strengthening Programme for Highway Structures - Stage 3 - Long Span Bridges

BD 56 The Assessment of Steel Highway Bridges and Structures

BD 61 The Assessment of Composite Highway Bridges and Structures

BA 16 The Assessment of Highway Bridges and Structures (a 1997 version is in the course of preparation)

BA 34 : Technical Requirements for the Assessment and Strengthening Programme for Highway Structures : Stage 1 - Older Short Span Bridges and Retaining Structures

BA 38 Assessment of the Fatigue Life of Corroded or Damaged Reinforcing bars

BA 44 The use of BD 44/90 for the Assessment of Concrete Highway Bridges and Structures

BA 54 Load Testing for Bridge Assessment

BA 55 The Assessment of Bridge Substructures and Foundations, Retaining Walls and Buried Structures

BA 56 The use of BD56 for the Assessment of Steel Highway Bridges and Structures

BA 61 The use of BD 61 for the Assessment of Composite Highway Bridges and Structures

16. The following is a list of Statutory Instruments to which reference is made in this Standard:

The Road Vehicles (Construction and Use) Regulations 1986 (SI 1986/1078) and Amendment No. 6 (SI 1995/3051)

The Motor Vehicles (Authorisation of Special Types) General Order 1979 (SI 1979/1198) and Amendment Order 1987 (SI 1987/1327)

The Traffic Signs Regulations and General Directions 1994

Motor Vehicles (Construction and Use) Regulations (Northern Ireland) 1989

Motor Vehicles (Authorisation of Special Types) Order (Northern Ireland) 1997 (SR 1997 No 109)

The Traffic Signs Regulations (Northern Ireland) 1979

11. ENQUIRIES

Approval of this document for publication is given by the undersigned:

Chief Highway Engineer
The Highways Agency
St Christopher House
Southwark Street
London SE1 0TE

T A ROCHESTER
Chief Highway Engineer

The Deputy Chief Engineer
The Scottish Office Development Department
National Roads Directorate
Victoria Quay
Edinburgh EH6 6QQ

N B MACKENZIE
Deputy Chief Engineer

The Director of Highways
Welsh Office
Y Swyddfa Gymreig
Crown Buildings
Cathays Park
Cardiff CF1 3NQ

K THOMAS
Director of Highways

Assistant Technical Director
Department of the Environment for
Northern Ireland
Roads Service
Clarence Court
10-18 Adelaide Street
Belfast BT2 8GB

D O'HAGAN
Assistant Technical Director

All technical enquiries or comments on this document should be sent in writing as appropriate to the above.

A. C&U AND EC VEHICLE AND AXLE WEIGHTS

A1. C&U Vehicle and Axle Weights

The maximum gross vehicle and axle weights allowable under the C&U Regulations* are tabulated below. In the case of vehicles these are associated with specified minimum axle spacings. Full details of these spacings and the corresponding gross vehicle weights for closer spacings are given in the regulations.

a. Rigid Vehicles

<u>No of axles</u>	<u>Gross Vehicle Weight (tonnes)</u>
2	17.00
3	24.39
4	30.49

b. Articulated Vehicles

<u>No of axles</u>		<u>Gross Vehicle Weight (tonnes)</u>
<u>Tractor</u>	<u>Trailer</u>	
2	1	24.39
2	2	32.52
2	3 or more	38.00
3	1	32.52
3	2 or more	38.00

c. Single Axle

<u>Gross Axle Weight (tonnes)</u>
10.5

d. Bogies

<u>No of Axles</u>	<u>o/a Minimum Axle Spread (m)</u>	<u>Gross Bogie Weight (tonnes)</u>
2	1.02	16.26
2	1.85	20.34
3	1.4	18.00
3	2.7	22.5
3	2.6+	24.0+

* Note: The references for the Statutory Instruments promulgating the C&U Regulations are given in 1.10.

+ Note: The C&U Regulations permit 3 axled bogies of 24 tonnes gross weight, provided that they have an air or fluid suspension. These bogies should be considered when undertaking arch assessments.

Appendix A

A2. EC Vehicle and Axle Maximum Weights

The maximum gross vehicle and axle weights for heavy lorries used in international transport allowable under Directive 85/3/EEC and last amended by 91/60/EEC are tabulated below. A derogation not to admit the more onerous vehicle types onto UK principal routes ends on 31 December 1998.

a. Rigid Vehicles

<u>No. of axles</u>	<u>Gross Vehicle Weight (tonnes)</u>
2	18
3	26
4	32

b. Articulated Vehicles and Road Trains with 5 or 6 axles

<u>No of axles</u>		<u>Gross Vehicle Weight (tonnes)</u>
<u>Tractor</u>	<u>Trailer</u>	
2	3	40
3	2 or 3	40 (44, 6 axles bimodal articulated lorries and drawbar trailer combinations)

c. Driving Single Axle

Gross Axle Weight (tonnes)
11.5 and \leq 25% of total laden weight

d. Bogies (Tandem and triaxles of tractors, trailers and semi trailers)

<u>No of Axles</u>	<u>o/a Minimum Axle Spread (m)</u>	<u>Gross Bogie Weight (tonnes)</u>
2	<1.0	11
	1.0	16
	1.3	18*
	1.8	20
3	<2.6	21
	<2.8	24

* 19 tonnes where a driving axle has 'road friendly suspension'

e. Maximum authorised weight depending on the wheelbase

\leq 5 times the distance (m) between foremost and rearmost axles of the vehicle.

f. Non Driving Single Axle

Gross Axle Weight (tonnes)
10.0

B. INCREASE IN LOADING DUE TO CENTRIFUGAL ACTION

Derivation of Factor F_A :

By taking moments about points 2 or 1

One obtains $R_1 = \frac{W}{2} \left(1 - \frac{2v^2h}{gd} \right)$

$$R_2 = \frac{W}{2} \left(1 + \frac{2v^2h}{gd} \right)$$

let $F_A = 1 + \frac{2v^2h}{gd}$

then $R_1 = \frac{W}{2} (2 - F_A)$

and $R_2 = \frac{W}{2} F_A$

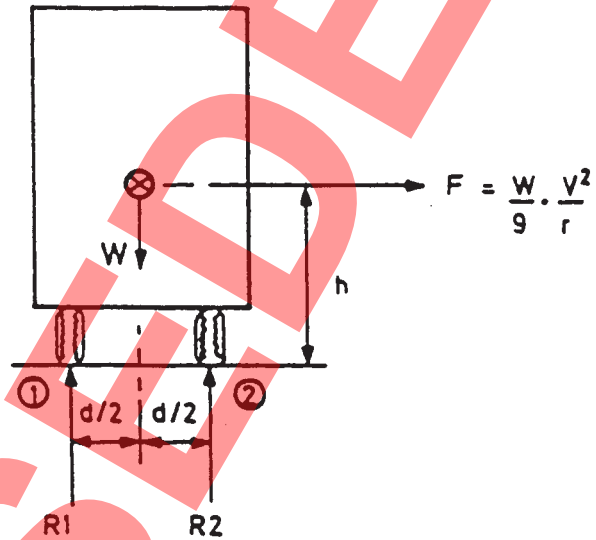

Figure B1

Where the loading is to be applied as an equivalent static live load in accordance with 5.34 to 5.36, $\frac{W}{2}$ may be considered as one of the longitudinal line loads or one of the point loads. The equivalent static live loads adjusted for centrifugal effects are given by R_1 and R_2 . Assuming conservatively, $h = 1.75$ m and $d = 1.8$ m the following value for factor F_A is obtained:

$$F_A = 1 + 0.20 \frac{v^2}{r}$$

Maximum value of r (above which centrifugal effect may be ignored): Centrifugal effects will only need to be considered when the adjustment of the static live loads is equal to or greater than 25%.

$$F_A = 1 + \frac{2v^2h}{gd} \geq 1.25, \text{ or } r < \frac{8v^2h}{gd}$$

Testing at the Transport Research Laboratory established the following relationship between v and r :

$$v = \sqrt{\frac{100gr}{r+150}}$$

Substituting for v in the above inequality gives

$$r < 800 \frac{h}{d} - 150$$

Substituting $h = 1.75$ and $d = 1.8$ m gives

$$r < 628 \text{ m}$$

which means that for a radius greater than 600 m (rounded value), centrifugal effects may be ignored.

C. PROPERTIES OF MATERIALS

C1. Wrought Iron

Determination of Characteristic Yield Stress. A value for the characteristic yield stress may be obtained by testing samples of material taken from the structure to be assessed.

Where such test results are to be used, the characteristic yield stress shall be inferred from these results by one of the following two methods:

- (i) The mean and standard deviation of the test results shall be calculated and the 95% one-sided tolerance interval determined with 95% confidence for the number of results available from Table 7 in annex B to BS 2846 : Part 3 : 1975 (use the column for $(1 - \alpha) = 0.95$, $P = 0.95$).
- (ii) The mean of the test results shall be calculated and an amount of

$$1.645 \sigma \left(1 + \frac{1}{\sqrt{n}} \right)$$

subtracted from it where

σ is the known standard deviation, to be taken as 26 N/mm²:

n is the number of test results.

Note: It must be appreciated that the yield stress of wrought iron determined from samples varies over a wide range, typically from 180 to 340 N/mm², and this range is not necessarily much narrower when samples are taken from the same structure. It is, therefore, unlikely that a few test results will provide any more reliable information about the yield stress of the material in the structure as a whole than the value given in 4.9, which is based on a large number of tests.

The methods of inferring the characteristic yield stress given above make allowance for this variation in results. The first method implies the determination of the standard deviation from the test results only and will give lower results for the characteristic yield stress, since it must allow for the wide possible variation in standard deviation. It is only likely to be suitable if more than ten test results are available.

The second method is based on the reasonable assumption that the standard deviation of results is the same for the samples taken from the particular structure as that determined from the larger number of results on which the value in 4.9 is based. This method is suitable for small numbers of results though, again, the allowance for uncertainty necessarily increases as the number of results is reduced.

British Standard	Minimum* Yield Strengths (N/mm ²)
<u>Mild Steel</u>	
BS 15: 1948 Amendment No 1 April 1959 Up to 20mm thickness 21mm to 51mm thickness #	247 230
BS 2762: 1956	
Notch ductile IA Up to 51mm thickness	220
Notch ductile IB Up to 51mm thickness	235
Notch ductile IIA Up to 51mm thickness	220
Notch ductile IIB Up to 51mm thickness	235
<u>High Yield Steel</u>	
BS 968: 1962	
Up to 16mm thickness	355
17mm to 32mm thickness	347
33mm to 51mm thickness	340

* The above table is only valid for plates, flats and sections up to 51mm thickness.

BS 15 revision September 1961. Universal beams and universal columns with flange thicknesses less than 38mm have minimum yield stresses of 247N/mm².

Table C2 Structural Steel: Minimum Yield Stresses to Post 1955 British Standards

D. LOADING FROM VEHICLES

D1. Introduction

The effect of vehicular traffic on cross-girders and slabs spanning transversely, and buried concrete box type structures with cover greater than 0.6m, can be determined directly by considering individual vehicles and using a suitable method of analysis such as a grillage computer program.

As a first step, transverse spanning members should initially be assessed using the simple methods given in BA 16 (DMRB 3.4) where these are appropriate. If this initial assessment shows that the members are inadequate, then further analysis using the loading and methods given in this Appendix shall be undertaken.

D2. Critical Vehicles

The details of critical vehicles for full assessment live loading are given in Tables D1 and D2. It is necessary to consider all these vehicles to determine the most onerous effects.

Table D3 gives details of the critical C&U vehicles to be considered for restricted assessment live loading.

D3. Vehicle Application and Lane Widths

The following loads shall be applied:

- a. Single vehicle (with single axle impact)
- b. Convoy of vehicles (jam situation with no axle impact)

All members shall be capable of sustaining the worst effects resulting from the separate application of these loads.

The carriageway shall be divided into 2.5m wide lanes which shall be located at the positions causing the most adverse loading effects. The vehicle(s) shall be positioned within the lane to cause the most onerous loading effect but there should be at least 0.7m lateral spacing between wheel centres of adjacent vehicles. The wheel loads should be applied at 1.8m transverse spacing on the axle over a 0.3 x 0.3m square contact area. In addition there will be a UDL of 5kN/m² where the carriageway width is such that it accommodates an integral number and a fractional part of a 2.5m lane. This load is applied over the fractional part of lane. The full effects of loading from vehicles in two adjacent lanes only shall be considered. For vehicles in other lanes a factor of 0.6 shall be applied to the loading effects. Where convoys of vehicles are considered the minimum distance between vehicles shall be 1.0m.

Where vehicles are used for the assessment of buried concrete box type structures (cover greater than 0.6m), the wheel loads shall be distributed from the carriageway to the top of the buried structure in accordance with BD 31 (in Scotland SB 3/88) (DMRB 3.4).

Appendix D

Vehicle Ref	Vehicle Gross Weight (tonnes)	No Axles	AXLE WEIGHTS AND SPACINGS										
			01 (m)	W1 (tonnes)	A1 (m)	W2 (tonnes)	A2 (m)	W3 (tonnes)	A3 (m)	W4 (tonnes)	A4 (m)	W5 (tonnes)	02 (m)
B1	30.48	4	1.0	6.09	1.02	6.09	4.08	9.15	1.2	9.15	-	-	1.0
C1	30.48	4	1.0	5.58	1.2	5.58	3.80	9.66	1.5	9.66	-	-	1.0
D1	32.52	4	1.0	4.06	2.0	10.16	4.20	9.15	1.2	9.15	-	-	1.0
E1	32.51	5	1.0	6.09	3.10	9.15	1.2	9.15	4.0	4.06	1.02	4.06	1.0
F1	38.00	5	1.0	5.80	2.4	9.70	4.2	7.50	1.35	7.50	1.35	7.50	1.0
G1	38.00	5	1.0	6.00	2.8	7.50*	1.5	10.50*	5.28	7.00	1.02	7.00	1.0
H1	38.00	5	1.0	5.86	2.45	6.00*	1.35	10.50*	5.28	7.82	1.02	7.82	1.0
J1	38.00	5	1.0	5.00	1.95	4.00	1.05	8.66	4.45	10.17	1.85	10.17	1.7

+ Note: W2 and W3 are interchangeable to determine the most adverse effect

Key: 01 and 02 - overhang (m)
W1, W2 etc - axle weights (tonnes)
A1, A2, etc - axle spacings (m)

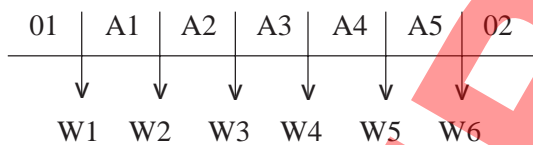

Table D1 Critical C&U Vehicles

Vehicle Ref	Vehicle Gross Weight (tonnes)	No Axles	AXLE WEIGHTS AND SPACINGS												
			01 (m)	W1 *	A1 (m)	W2 *	A2 (m)	W3 *	A3 (m)	W4 *	A4 (m)	W5 *	A5	W6 *	02 (m)
Ec1	26.0	3	1.0	7.0	3.9	11.5+	1.3	7.5+	-	-	-	-	-	1.0	
Ec2	32.0	4	1.0	6.5	1.2	6.5	3.9	11.5+	1.3	7.5+	-	-	-	1.0	
Ec3	40.0	5	1.0	7.0	3.9	11.5+	1.3	7.5+	3.0	7.0	2.8	7.0	-	1.0	
Ec4	44.0	6	1.0	7.0	3.9	11.5+	1.3	7.5+	3.6	6.0	1.2	6.0	1.2	1.6	

* = tonnes

+ Note: W2 OR W3 OR w3 AND w4 are interchangeable to determine the most adverse effect

Table D2 Critical EC Vehicles

D4. Vehicle Nominal Loading

The nominal loading in each lane shall be as follows:

- a. Single vehicle - An impact factor of 1.8 shall be applied to the most critical axle of the vehicle positioned at the most onerous part of the influence line diagram. See Chapter 14 of reference 4. The factored axle and remaining unfactored axles shall be taken as the nominal loads.
- b. Convoy of vehicles - The unfactored axle weights shall be taken as the nominal loads.

The partial factors for loads given in this Standard shall be applied for deriving assessment load effects.

Assessment Live Loading Level *	Vehicle Ref	Vehicle Gross Weight *	No Axles	AXLE WEIGHTS AND SPACINGS										
				01 (m)	W1 *	A1 (m)	W2 *	A2 (m)	W3 *	A3 (m)	W4 *	A4 (m)	W5 *	02 (m)
25	RA	20.32	3	1.0	4.06	2.18	8.13	1.02	8.13	-	-	-	-	1.0
	RB	24.38	3	1.0	6.10	3.70	9.14	1.2	9.14	-	-	-	-	1.0
	RC	24.39	3	1.0	6.10	3.60	10.16	1.5	8.13	-	-	-	-	1.0
	RD	24.39	3	1.0	6.39	3.60	10.50	1.5	7.50	-	-	-	-	1.0
17	RE	17.00	2	1.0	6.50	3.0	10.50	-	-	-	-	-	-	1.0
7.5	RF	7.50	2	1.0	6.0	2.0	1.50	-	-	-	-	-	-	1.0
3	RG	3.00	2	0.75	2.10	2.0	0.90	-	-	-	-	-	-	0.75

+ Note: W2 and W3 are interchangeable to determine the most adverse effect

Table D3 C&U Vehicles to be Considered When Assessing for Restricted Assessment Live Loading Levels

E. FIRE ENGINES

Make of Fire Engine	Gross Weight (tonnes)	Axle Spacing (m)	Weight Distribution (tonnes)			
			Front	Rear		
Dennis DF	16.26	3.60	6.10	-	10.16	Group 1
Leyland MS 1600	16.26	3.68	6.61	-	10.17	
Leyland MS 1600	16.26	4.62	6.61	-	10.17	
Leyland MS 1600	16.26	5.26	6.61	-	10.17	
Dodge	16.26	5.8	6.61	-	10.17	
Dodge	16.26	5.2	6.61	-	10.17	
Dodge	16.26	4.5	6.61	-	10.17	
Dodge	13.21	4.04	4.83	-	9.15	
Dodge	13.21	3.8	4.83	-	9.15	
Ford	13.0	3.73	4.83	-	9.15	
Ford	13.0	4.04	4.83	-	9.15	
Bedford SLR1	12.55	3.84	4.37	-	8.89	
Bedford SLRA	12.55	3.51	4.37	-	8.89	
Dodge	12.20	3.50	4.58	-	8.64	
Dennis RS & SS	11.70	3.60	4.80	-	7.20	
Dodge	7.50	3.50	3.26	-	5.08	Group 2
Dodge	6.60	3.60	2.30	-	4.90	

Table E1 Fire Engines

E1. Loading

The above table contains the critical fire engines for Group 1 and 2 assessment levels. The vehicle loading is to be applied as described in Appendix D, excepting that a maximum of 3 fire engines, together with any other vehicles of the appropriate type, shall be applied to the structure at any one time.

F. AXLE WEIGHTS FOR RESTRICTED ASSESSMENT LIVE LOADINGS

Restricted Assessment Live Loading (tonnes)	Maximum Gross Vehicle Weight (GVW) (tonnes)	Maximum Axle Weight (tonnes)	
		Single Axle	Double Axle (per Axle)
33	32.5	10.5	9.5
25	24.5	10.5	9
17	17	10.5	-
13	12.5	9	-
10	10	7	-
7.5	7.5	5.5	-
3	3	2	-
Fire Engines			
Group 1		10	-
Group 2		5	-

Table F1 Axle Weights for Restricted Assessment Live Loadings

G. BACKGROUND TO TYPE HA LOADING AND ASSESSMENT LIVE LOADING

G1. Introduction

The type HA loading Assessment Live loading for short spans (2-50m length) has been derived from first principles using the latest available data. The method used to derive the loading has been compared with some findings from the work to determine the partial material factors in BS 5400 : Part 3, which uses probability theory. These findings indicated that the 95% characteristic load (ie 5% chance of occurring in 120 years) was approximately the same as the current serviceability loading, ie $1.2 \times HA$. Using the same statistical load model it was shown that the ultimate load (ie $1.5 \times HA$) occurred with a return period of 200,000 years or 0.06% chance in 120 years. This latter concept has been adopted for deriving the new loading by assuming that the worst credible load that can reasonably be expected to occur in the lifetime of the bridge will be equivalent to $1.5 \times HA$. Hence the value of the nominal HA can be found directly by dividing by 1.5.

Four elements have been used to generate the extreme loads, namely:

- (i) Loading from EC vehicles and legal C&U vehicles;
- (ii) Impact;
- (iii) Overloading;
- (iv) Lateral bunching.

Each of these elements is discussed in more detail later. The loading has been derived for a single lane only. It has been assumed that if two adjacent lanes are loaded there is a reasonable chance that they will both be equally loaded.

G2. Vehicle Loading and Impact

It has been assumed that spans can be fully occupied by convoys of particular vehicles which are fully laden to the limits prescribed by the C&U Regulations or for EC vehicles as appropriate. The bending moment and shear force effects on a simply supported span due to specified numbers of these vehicles have been derived using a computer program which automatically selects the most onerous load case. By running a comprehensive range of all the possible vehicles it was possible to produce an envelope of moments and shears for all current legal C&U vehicles and 40/44 tonne EC vehicles. It was assumed that there was a 1 metre gap between each vehicle.

Impact was included only in those computer runs which were for a single vehicle and was applied only to the heaviest axle. Based on TRRL report LR 722 the value of 1.8 was adopted as the extreme impact factor, whose effect was thus included in the bending moment and shearing force envelopes.

The results of the computer runs indicated that the loading could be broadly divided into three span regions, namely: (i) 0-10m, where axle or bogie loading is dominant, (ii) 25-50m, where multiple vehicle loading is dominant, and (iii) a transition region 10-25m where the loading changes from axle or bogie to vehicle dominant. The transition region also includes cases where single vehicles dominate the loading effects. Table G1 illustrates the dominant loading for the various spans.

Span (m)	Bending Moment	Shear Force	Rationalised Effects	
			Span Range	Loading
2	Si. Ax.	Do. Ax.	0 - 10m	Axle Dominated
4	Do. Ax.	Do. Ax.		
6	Do. Ax.	Tr. Ax.		
8	Tr. Ax.	Si. Ne.		
10	Tr. Ax.	Do. Ve.		
12	Do. Ve.	Do. Ve.	10 - 25m	Transition
14	Si. Ve.	Tr. Ve.		
16	Si. Ve.	Tr. Ve.		
18	Si. Ve.	Tr. Ve.		
20	Tr. Ve.	Tr. Ve.		
22	Tr. Ve.	Mu. Ve.		
24	Tr. Ve.	Mu. Ve.		
26	Mu. Ve.	Mu. Ve.	25m and above	Vehicle Dominated
28	Mu. Ve.	Mu. Ve.		
30	Mu. Ve.	Mu. Ve.		
⋮	⋮	⋮		
⋮	⋮	⋮		
⋮	⋮	⋮		
50m +	Mu. Ve.	Mu. Ve.		

Legend:

Si. = Single
 Do. = Double
 Tr. = Triple
 Mu. = Multiple (> 3)

Ax. = Axle
 Ve. = Vehicle

Table G1 Dominant Loading for Various Spans

G3. Overloading

The amount of overloading was determined from the results of roadside surveys of C&U vehicles carried out by TRL at three main road sites. Axle and vehicle weights were determined using static weighbridges and the results presented for various vehicle types. From a knowledge of the legal limits for particular vehicles and axle configurations, it was possible to derive an extreme overload factor. This was taken as 1.4, from 2 to 10m spans, reducing linearly from 10m span to unity at 60m span, where, with a seven vehicle convoy, it could reasonably be expected that any overloaded vehicles would be balanced by partially laden ones.

G4. Lateral Bunching

An allowance was made for the case where more than one line of vehicles can squeeze into a traffic lane. The factor was based on the ratio of the standard lane width, 3.65, to the maximum vehicle width under C&U Regulations, 2.5m. The factor has been assumed to be constant up to 20m, where there is a good chance of having adjacent lines of two lorries in each line, reducing to unity at 40m where the chances of getting two lines of five lorries side by side are remote.

It should be noted that corresponding compensating factors have been provided in 5.25 to allow for the cases where the actual lane widths are less than the standard lane width. In these cases the derived assessment loading should be reduced by the appropriate factor.

G5. Calculation of Type HA Design Loading

For both shear and moments and for each span, the C&U and EC envelope values, which include any impact effect, have been multiplied by the appropriate value of the span-dependent overloading and lateral bunching factors. The resulting moments and shears have then been divided by 1.5 to give the nominal values but increased by 10% to allow for any unforeseen changes in traffic patterns. The effect of the 120 kN knife edge has then been removed from the moments and shears and an equivalent, uniformly distributed loading derived. The worst UDL from the moment and shear calculations was always the shear value and this has been taken at each particular span. The equation given in 5.19 was found to give a very good fit with the calculated values.

G6. Calculation of Assessment Live Loadings

The values of the Assessment Live Loadings (see 5.8 to 5.34) have been determined in a similar way to the Type HA Loading but using an envelope containing those vehicles whose gross weight is equal to or less than the maximum weight specified for the particular loading. However no 10% contingency allowance has been included in the calculations and there are some other differences which are described in the following paragraph.

In the case of fire engines the maximum convoy has been limited to three vehicles, with any remaining space being filled with car loading (3 tonnes Assessment Live Loading). For fire engines no overload factor has been taken since it was assumed that there is a definite limit to the amount of water that they can carry. Use of the overload factor for cars has been modified to take account of their shorter length and the lateral bunching factor has also been increased to take account of their narrower width.

G7. Comments on Loading

It should be noted that the various factors which have been used in determining the loading are span dependent and that they are used to derive an ultimate or extreme load rather than a working load. For serviceability it is difficult to ascribe values to the individual factors, but their combined effect will be reduced in the ratio 1.2:1.5. It should also be noted that there has been a considerable growth in commercial traffic over the years and that convoys of eight or more HGVs are quite common on some routes. However, allowing for this situation means that the derived loading will be conservative for medium length spans on lightly trafficked routes, where the probability of ever having a bridge completely filled with heavy vehicles is small. For the shorter spans which can only accommodate a small number of HGVs, the loading should not be considered conservative given the likelihood that the bridge

Appendix G

will suffer full loading conditions even on little used roads.

The impact factor has been derived from measurements taken on motorway overbridges which are of modern construction and where the road surface and bridge joints were likely to have been in good condition. The road surfaces at older bridges are unlikely to be in such good state and therefore the impact effects are unlikely to be less than those measured, except in cases where the traffic is forced to move at a slow speed. The overload factors have been derived from a sample survey of about 3500 vehicles and may thus be assumed to be typical of what may occur at any time, or in any place in the country.

From the discussion above it will be seen that the factors which have been used in deriving the loadings can be said to be fairly universal in application and reflect situations which may occur at any bridge site. However the C&U and EC envelopes may be conservative for the longer bridge short spans, where the loading is dominated by several vehicles in convoy, if the traffic is light, or there is a low proportion of heavy goods vehicles. However, even in these cases there is always the possibility that the full envelope loading may be attained as a result of an accident causing a jam of vehicles or other interruption to the normal traffic pattern.

SUPERSEDED

H. BACKGROUND TO THE REQUIREMENTS FOR MASONRY ARCH BRIDGES

H1. Partial Safety Factor (γ_{fl}) for Live Loads

The ultimate limit state load for C&U vehicles, in terms of a single axle load, is the maximum permitted axle load multiplied by an impact factor, 1.8, and an overloading factor, 1.4, giving a total γ_{fl} of 2.52. From the serviceability point of view, pending any detailed statistical examination, it will be reasonable to assume that only a loading equivalent to the nominal HA loading will be applied to the structure on any regular basis. The nominal HA load equivalent is approximately the ultimate limit state load divided by 1.5 (see Appendix G), ie 2.52 divided by 1.5 or, say, 1.7 times the maximum permitted axle load. Examination of typical load deformation curves from the ten TRL tests (Ref 11), a few examples of which are given in Figure H1, shows that deformations increase rapidly as the applied load exceeds approximately half the ultimate failure load. In order to avoid causing any permanent structural damage, therefore, it will be prudent to limit regularly applied loading, pending a detailed investigation regarding serviceability, to half the ultimate failure load. This can also be inferred from reports of first damage observed in various full-scale tests. This implies a γ_{fl} of 3.4. Taking the greater of the two values, therefore, a live load γ_{fl} of 3.4 for a single axle is recommended for masonry arches.

When multiple-axle EC or C&U vehicles are used in the analysis, a γ_{fl} of 3.4 should be used for the critical axle. However, as the impact factor of 1.8 is not considered to be applicable to the other axles, a pro-rata reduction can be made giving γ_{fl} of 1.9 for these axles.

When the configuration and speed of a vehicle at the time of crossing is known with some precision, as in the case of some abnormal indivisible loads, the possibility of overloading and impact may be ignored and a γ_{fl} of 2.0 may be considered adequate.

H2. Effective Width for Wheel Loads

H2.1 The analysis of an arch is generally carried out for a unit width of the barrel. In order to calculate the effects of wheel loads applied at the road surface, it is therefore necessary to determine the effective widths.

H2.2 The effective width for a wheel load has two components - the dispersal through the fill material and the transverse structural action of the barrel itself. Based on the examination of a number of experiments on full scale bridges reported by Davy (Ref 12) and Chettoe and Henderson (Ref 13), the following approximate formula for effective widths, for a wheel load applied at any position along the span, has been devised:

$$w = h + 1.5$$

where both w and h are in metres.

The above formula is intended to be somewhat conservative compared to the test results referred to in H2.3 since, approaching failure, loads may become more concentrated than was the case during the tests. When the effective widths for a number of wheels overlap transversely, the total effective width will be that between the outer points.

H2.3 It should be noted that the true effective width would depend upon a number of factors, including the aspect ratio. Therefore, the above formula should be used as a conservative approximation until further work is carried out to investigate the transverse distribution of load effects. Nevertheless, as shown in Table H1, this formula gives reasonable agreement with the effective widths for a 4-wheel axle determined experimentally by Chettoe and Henderson (Ref 13) for a number of arch bridges, and for a single wheel load determined by Davy (Ref 12) for Alcester bridge.

Appendix H

Bridges	In-Situ Tests (m)	Proposed Formula (m)
Itchen Abbas	13.9	13.0
Abbotsworthy	14.2	13.0
Wetherby	16.4 *	12.5
Rudgwick	13.2	12.2
Crawley Down	16.8	13.7
Hazelden	18.8 **	12.5
Blythe End	15.69	13.2
Alcester	2.55	1.8

* Limestone Fill
** Concrete Fill

Table H1 Transverse Effective Widths for a 4 Wheel (HB Type) Axle

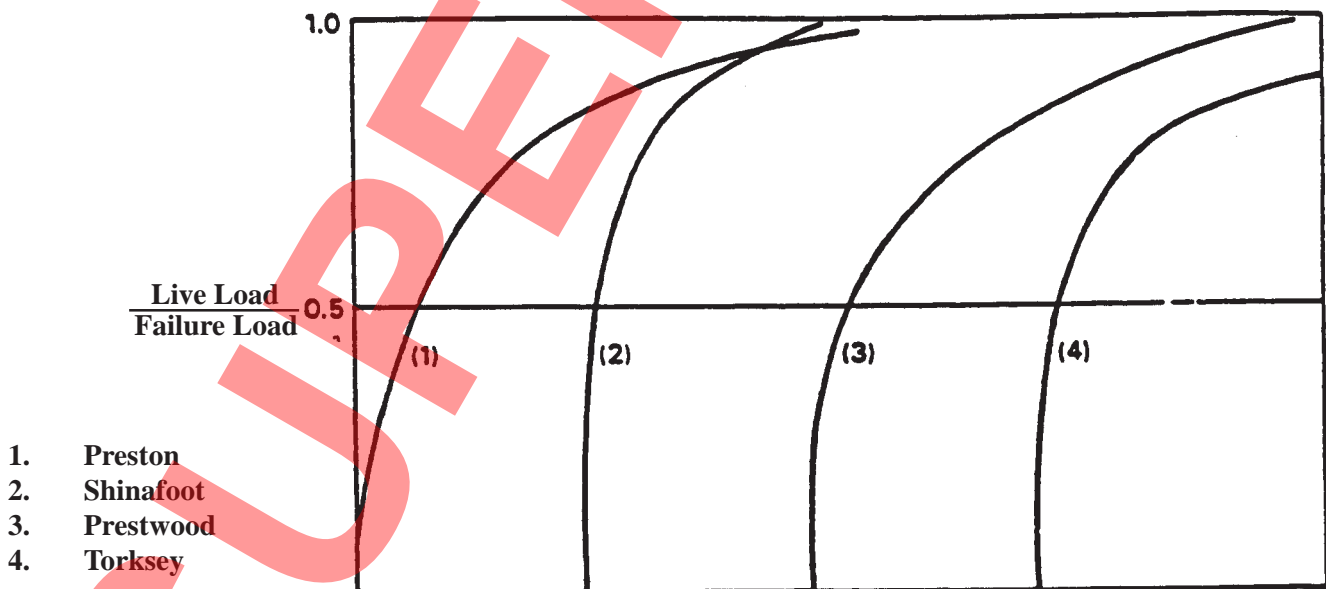

Figure H1 Load Deformation Curves

J. ASSESSMENT OF BRIDGE DECK CANTILEVERS FOR ACCIDENTAL WHEEL LOADING

J1. Derivation of Accidental Wheel Loading (AWL)

The AWLs have been derived from their actions upon infinitely long cantilever slab elements up to 3 metres wide. The loading values of the four wheeled AWL configurations (Table 5.4) have been determined so that when multiplied by 1.5 they produce similar peak elastic cantilever root ultimate moments as would single real vehicles placed on the cantilever slab. Wheel loads are factored upwards to represent the worst credible loading case. The factors used for the real vehicles are 1.8 impact factor (one axle only) and a 1.4 overloading factor (all axles). Westergaard's equation was used to determine the peak elastic moments and the calculations were carried out for the range of vehicles contained within each load assessment band. The most onerous values are then taken. The method is not suitable for non-cantilevered members and an accidental vehicle from Appendix D shall be used instead.

J2. Assessment of Existing Structures

- (i) The Westergaard equation used to determine the requirements in this Standard is an elastic method, and produces a considerable peak value of moment in line with the heaviest axle. For new designs adequate reinforcement can be provided to prevent the initiation of local failure. However, an elastic method can be onerous for the assessment of existing structures as an actual collapse cannot occur until a mechanism has been set up along a length of cantilever root together with failure planes within the deck area adjacent to the errant vehicle;
- (ii) For cantilevers where assessments of the local effects of the AWL using elastic methods of analysis indicate inadequacies, consideration should be given to the use of non-linear plastic analysis such as yield line methods. Vehicles as given in Appendices D and E rather than AWL, should be used for this analysis. Use of this method of analysis is referred to in BD44 (DMRB 3.4). It is important to also ensure that local shear strength is adequate and that the reinforcement is sufficiently ductile to allow the rotations at any yield line to safely occur. Attention should also be given to the boundary conditions assumed for the cantilever connection to the adjacent section of deck, to ensure the overall structural action is being correctly modelled for the AWL loading case. Cantilevers are often modelled with a rigid support at the root although many decks do allow some flexural rotation to occur, which may allow the peak loading effects to be dispersed;
- (iii) The use of such collapse analysis methods makes allowance for the mobilization of the full strength of the structure, therefore the assessed capacity may be greatly in excess of that derived from elastic considerations. However, in achieving this mobilization considerable local yield may occur along the lines of failure, leading to possible excessive cracking and subsequent loss of durability at that location. Hence, when a large gain in assessed capacity is achieved through the use of these methods, increased frequency of inspection of such locations may be considered necessary;
- (iv) For elements which are still found to be inadequate following the more detailed analysis mentioned in J2 (ii) above, consideration should be given to strengthening or replacement;
- (v) Locations where cantilevers are terminated or discontinuous need to be considered as special cases. These locations have been frequently provided with additional local strength in the original design. If not, or if such locally enhanced strength is found to be insufficient, these locations may need additional strengthening;
- (vi) Where strengthening or replacement is not possible or practical, the provision of an 'effective barrier' (see Chapter 5) should be considered.

J3. Effective Barriers

- (i) The only fully 'effective barriers' currently available to prevent vehicles of the types associated with AWLs travelling onto deck cantilevers are P6 parapets (BD 52 (DMRB 2.3) refers) and higher containment (1.2m high) concrete barriers. However, these barriers are unlikely to be suitable for use on many bridge decks for a number of reasons, including consideration of available space, fixity, environmental impact and the need to use long safety fence transitions, as well as the large additional dead weight of concrete barriers. Where an 'effective barrier' is provided, AWL need not be considered on the cantilever area, although it does still need to be considered on the traffic side of the barrier. Strength of local elements of the bridge, verge width, necessary setbacks, drainage, and visibility requirements also need to be considered;
- (ii) Where a fully 'effective barrier' is not appropriate or possible, the installation of a partially 'effective barrier' may be considered, provided that cantilevers are adequate to carry the nominal live loading which is represented by the most onerous vehicle for the appropriate assessment level given in Appendices D and E (impact factor should not be applied). The ultimate live loads should be taken as the nominal live loads multiplied by a γ_{fL} factor of 1.5 (γ_{f3} should not be applied). The use of non-linear plastic methods of analysis may be considered. A partially 'effective barrier' is a physical obstruction such as a safety fence, which does not allow vehicles (other than errant vehicles) to enter or park on areas supported by inadequate cantilevers.